

»Features

- Fast Switching Speed
- High Conductance
- Low forward voltage
- Fast reverse recovery time

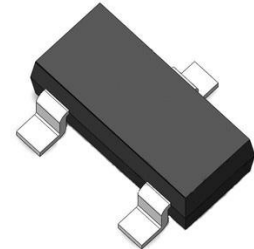

»General Description

- SOT-23 Small Outline Plastic Package
- Polarity: Color band denotes cathode end
- Mounting Position: Any

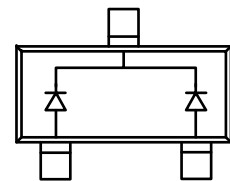

»Absolute Maximum Ratings @ $T_A=25^{\circ}\text{C}$ unless otherwise noted

Symbol	Parameter	Value	Unit
VRM	Non-Repetitive Peak Reverse Voltage	50	V
VR	DC Blocking Voltage	50	V
IO	Average Rectified Output Current	200	mA
IFSM	Non-repetitive Peak Forward Surge Current@8.3mS	2.0	A
Pd	Power Dissipation	225	mW
RθJA	Thermal Resistance From Junction To Ambient	550	°C/W
TJ	Operation Junction Temperature Range	-55~+150	°C
TSTG	Storage Temperature Range	-55~+150	°C

»Electrical Characteristics @ $T_A=25^{\circ}\text{C}$ unless otherwise noted

Symbol	Parameter	Test conditions	Min	Typ	Max	Unit
V(BR)	Reverse breakdown voltage	IR=5μA	50			V
IR	Reverse current	VR=50V			0.1	μA
VF1	Forward voltage	IF=100mA			1.0	V
CT	Capacitance between terminals	VR=0V, f=1MHz			2	pF
trr	Reverse recovery time	IF=IR=10mA, RL=100Ω, Irr=0.1XIR		1.6	4	nS

»Typical Performance Characteristics (T_J = 25 °C, unless otherwise noted)

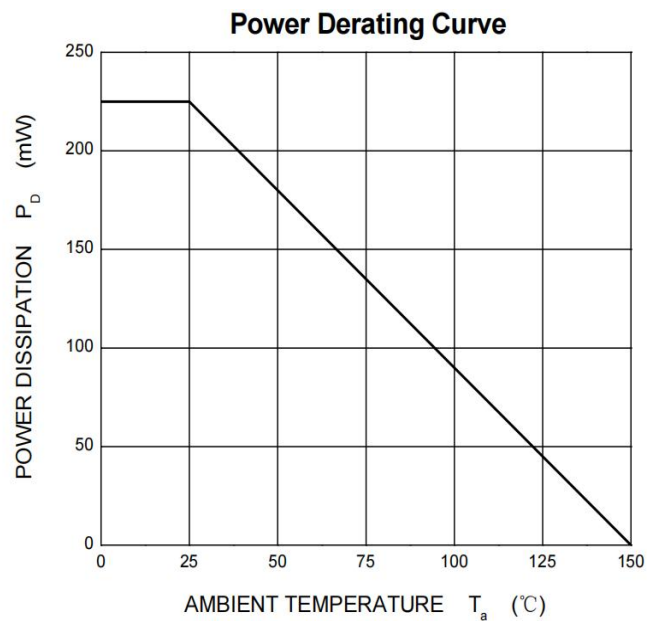
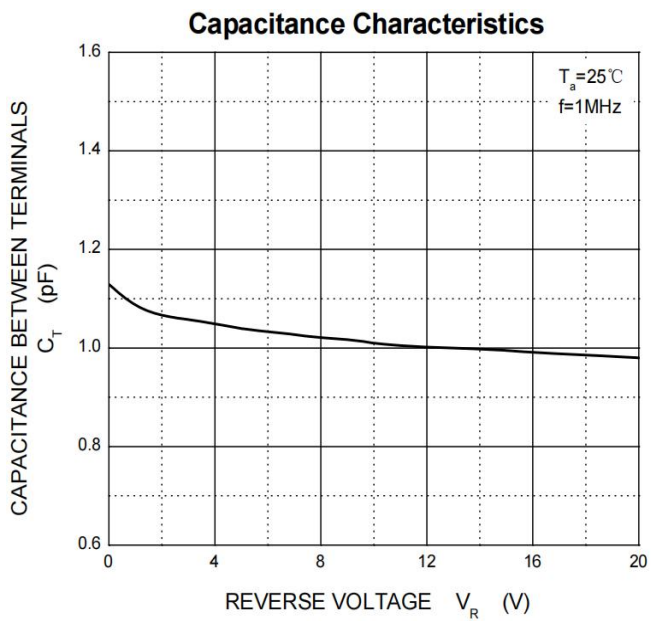
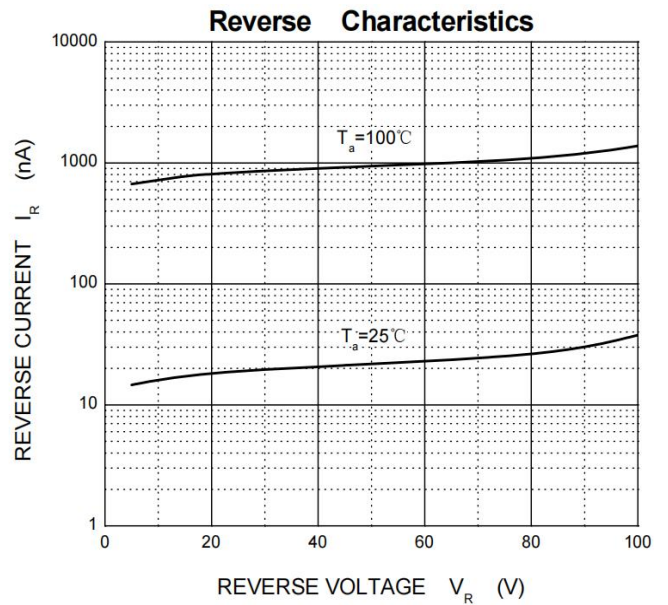
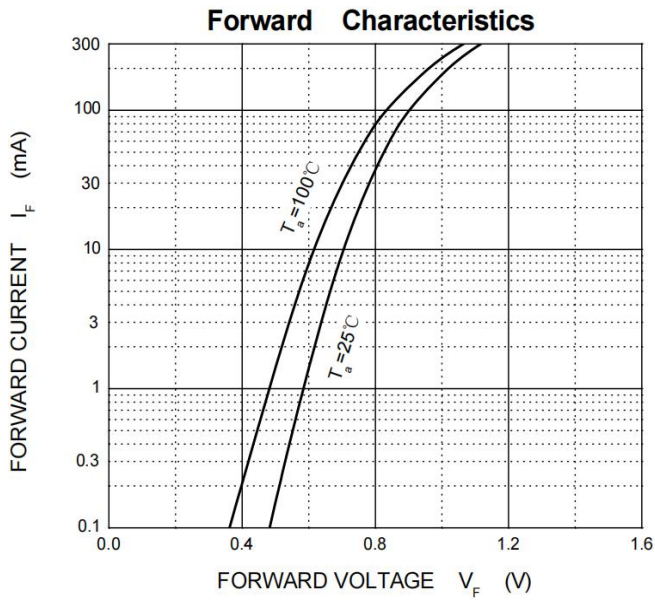

»Package Information SOT-23

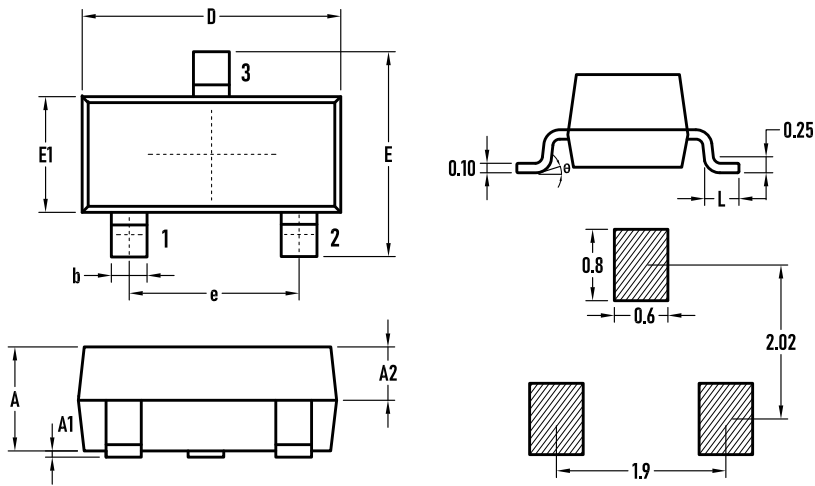

SYMBOL	MILLIMETER		
	MIN.	Typ.	MAX.
A	0.90	1.00	1.10
A1	0.02	0.06	0.10
A2	–	0.60	–
D	2.85	2.90	2.95
b	0.37	0.40	0.43
E	2.35	2.40	2.45
E1	1.25	1.30	1.35
e	1.85	1.90	1.95
L	0.35	0.40	0.48
θ	0	–	6°

»Marking

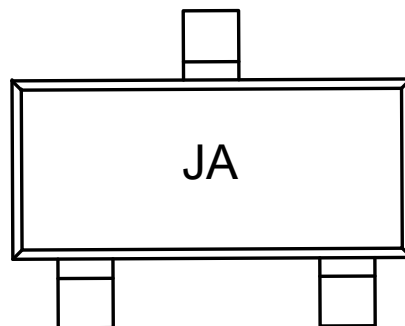

»Ordering information

Order code	Package	Base qty	Delivery mode
BAV74	SOT-23	3K	Tape and reel