



FEATURES

- Epitaxial planar die construction
- Ideal for low power amplification and switching

MAKING: K6N



Maximum Ratings @Ta=25°C

Symbol	Parameter	Value	Units
V_{CBO}	Collector-Base Voltage	60	V
V_{CEO}	Collector-Emitter Voltage	40	V
V_{EBO}	Emitter-Base Voltage	6	V
I_C	Collector Current -Continuous	0.2	A
P_C	Collector Power Dissipation	0.2	W
T_J, T_{stg}	Operation Junction and Storage Temperature Range	-55~+150	°C

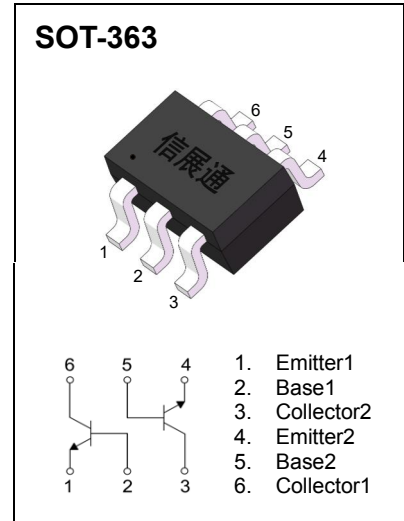
ELECTRICAL CHARACTERISTICS(T_a=25°C unless otherwise specified)

Parameter	Symbol	Test conditions	Min	Typ	Max	Unit
Collector-base breakdown voltage	$V_{(BR)CBO}$	$I_C=10\mu A, I_E=0$	60			V
Collector-emitter breakdown voltage	$V_{(BR)CEO}$	$I_C=1mA, I_B=0$	40			V
Emitter-base breakdown voltage	$V_{(BR)EBO}$	$I_E=10\mu A, I_C=0$	6			V
Collector cut-off current	I_{CBO}	$V_{CB}=30V, I_E=0$			0.05	μA
Emitter cut-off current	I_{EBO}	$V_{EB}=5V, I_C=0$			0.05	μA
Collector cut-off current	I_{CEX}	$V_{CE}=30V, V_{BE(off)}=3V$			0.05	μA
DC current gain	$h_{FE(1)}$	$V_{CE}=1V, I_C=0.1mA$	40			
	$h_{FE(2)}$	$V_{CE}=1V, I_C=1mA$	70			
	$h_{FE(3)}$	$V_{CE}=1V, I_C=10mA$	100		300	
	$h_{FE(4)}$	$V_{CE}=1V, I_C=50mA$	60			
	$h_{FE(5)}$	$V_{CE}=1V, I_C=100mA$	30			
Collector-emitter saturation voltage	$V_{CE(sat)1}$	$I_C=10mA, I_B=1mA$			0.2	V
	$V_{CE(sat)2}$	$I_C=50mA, I_B=5mA$			0.3	V
Base-emitter saturation voltage	$V_{BE(sat)1}$	$I_C=10mA, I_B=1mA$	0.65		0.85	V
	$V_{BE(sat)2}$	$I_C=50mA, I_B=5mA$			0.95	V
Transition frequency	f_T	$V_{CE}=20V, I_C=10mA, f=100MHz$	300			MHz
Collector output capacitance	C_{ob}	$V_{CB}=5V, I_E=0, f=1MHz$			4	pF
Noise figure	NF	$V_{CE}=5V, I_C=0.1mA, f=1kHz, R_S=1K\Omega$			5	dB
Delay time	t_d	$V_{CC}=3V, V_{BE(off)}=-0.5V$			35	nS
Rise time	t_r	$I_C=10mA, I_{B1}=-I_{B2}=1mA$			35	nS
Storage time	t_s	$V_{CC}=3V, I_C=10mA$			200	nS
Fall time	t_f	$I_{B1}=-I_{B2}=1mA$			50	nS



Typical Characteristics

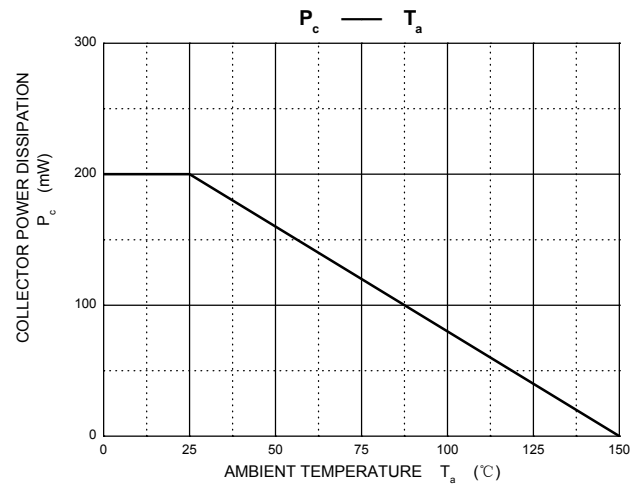
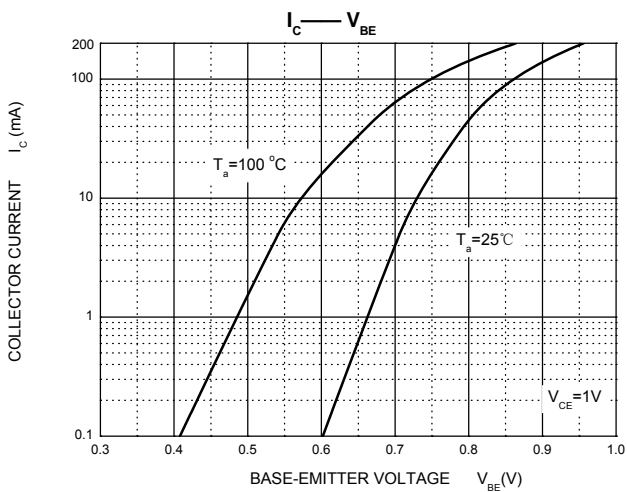
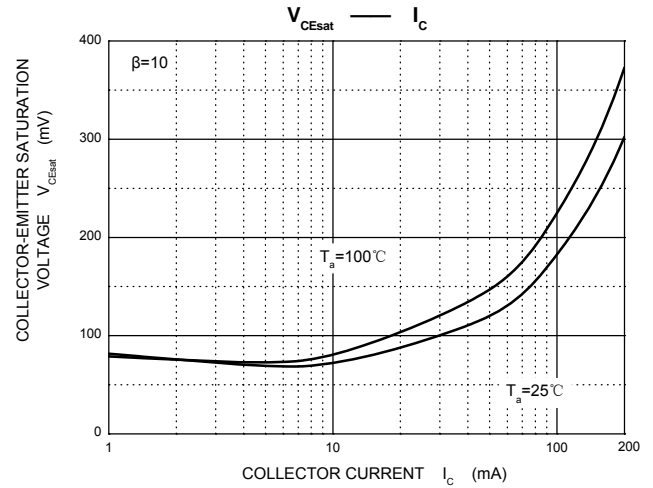
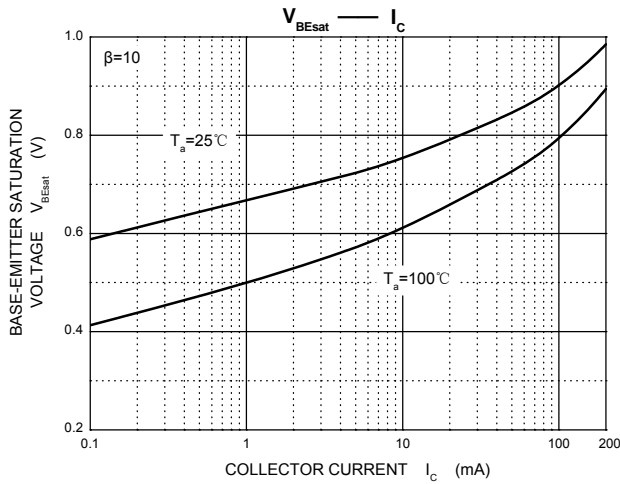
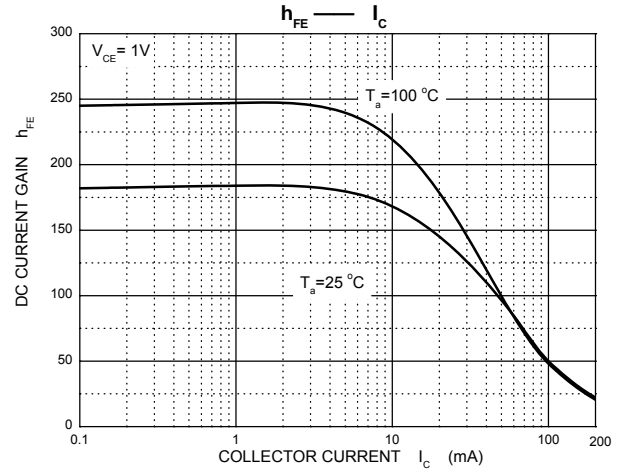
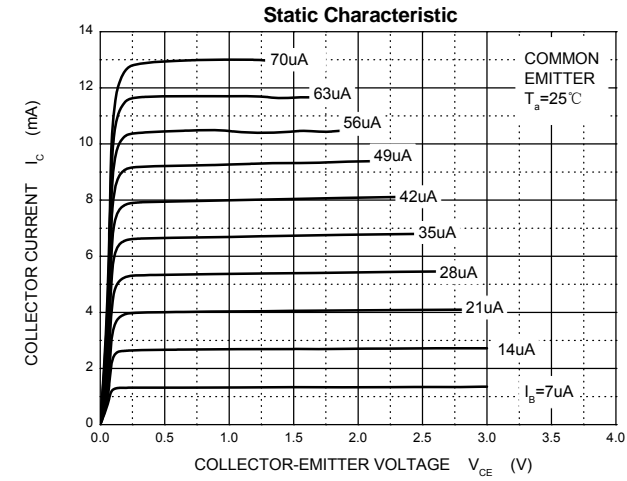



SOT-363 Package Outline Dimensions

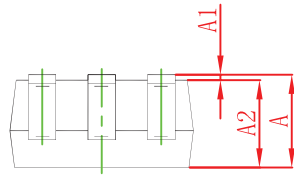
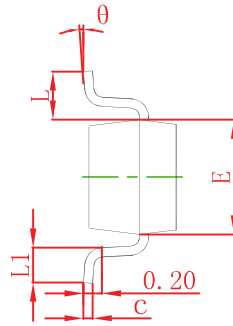
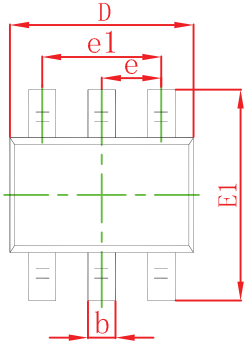

Symbol	Dimensions In Millimeters		Dimensions In Inches	
	Min	Max	Min	Max
A	0.900	1.100	0.035	0.043
A1	0.000	0.100	0.000	0.004
A2	0.900	1.000	0.035	0.039
b	0.150	0.350	0.006	0.014
c	0.100	0.150	0.004	0.006
D	2.000	2.200	0.079	0.087
E	1.150	1.350	0.045	0.053
E1	2.150	2.400	0.085	0.094
e	0.650 TYP		0.026 TYP	
e1	1.200	1.400	0.047	0.055
L	0.525 REF		0.021 REF	
L1	0.260	0.460	0.010	0.018
theta	0°	8°	0°	8°

SOT-363 Suggested Pad Layout

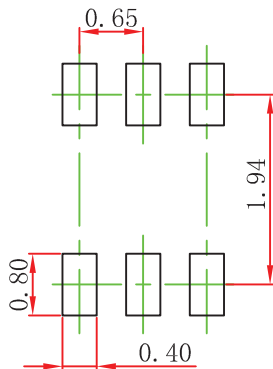

- Note:
1. Controlling dimension: in millimeters.
 2. General tolerance: $\pm 0.05\text{mm}$.
 3. The pad layout is for reference purposes only.