



LUCKI CM ELECTRONICS Co.,Ltd



APPROVAL SHEET

Customer : _____

Part Number: 2016 Seam Sealing Crystal

LK Part No.: L214S260C313L

Holder : SMD2016

Frequency: 26.000MHZ 7.3PF \pm 10PPM

Manufacturer: Lucki Electronics

Date: 2023-05-22

Prepared	Checked	Approved
Zhao Qian	Zhang Dongwei	Zhang Bin

(For Customer Use)

Acceptable	



LUCKI CM ELECTRONICS Co.,Ltd



Revision History

No.	Revised Date	Change Content	Approved	Remark



LUCKI CM ELECTRONICS Co.,Ltd



1. Electrical characteristics

Items	Symbol	Specification			Unit	Notes
		Min	Typ	Max		
Model No		Seam Seal 2016				
Blank Cutting Mode		AT FUND.				
Nominal Frequency	F0	26.000			MHz	
Oscillation Mode		<input checked="" type="checkbox"/> Fundamental <input type="checkbox"/> 3rd				
Frequency Tolerance	$\Delta F/F0$	-10		10	ppm	25°C ± 3°C
Load Capacitance	CL		7.3		pF	
Frequency Stability	TC	-15		15	ppm	
Operating Temperature	Topr	-40		85	°C	
Storage Temperature	Tstg	-55	~	125	°C	
Drive Level	DL		100	300	uW	
Effective Resistance RR	Rr	-	-	40	Ω	
Shunt Capacitance C0	C0	-	-	2	pF	
Trim Sensitivity TS	TS	-	-	-	ppm/PF	
Insulation Resistance	IR	500	-	-	MΩ	at DC 100 V
Aging:	Fa	-2		2	ppm	Per year
Weight			0.0062		g	

Remark: Sample Data See Attachment

Measure equipment :

Electrical characteristics measured by S&A 250B or equivalent.

Hermetically :

Fine Leak: Helium Bombing 4kg/cm² for 1 Hour, Leak ate Less Than ⁻⁸atm. cc/sec 1×10

Gross Leak: 125°C FC#40 , 120 Seconds, No Bubble



LUCKI CM ELECTRONICS Co.,Ltd



2. Solder Dimension And Pattern

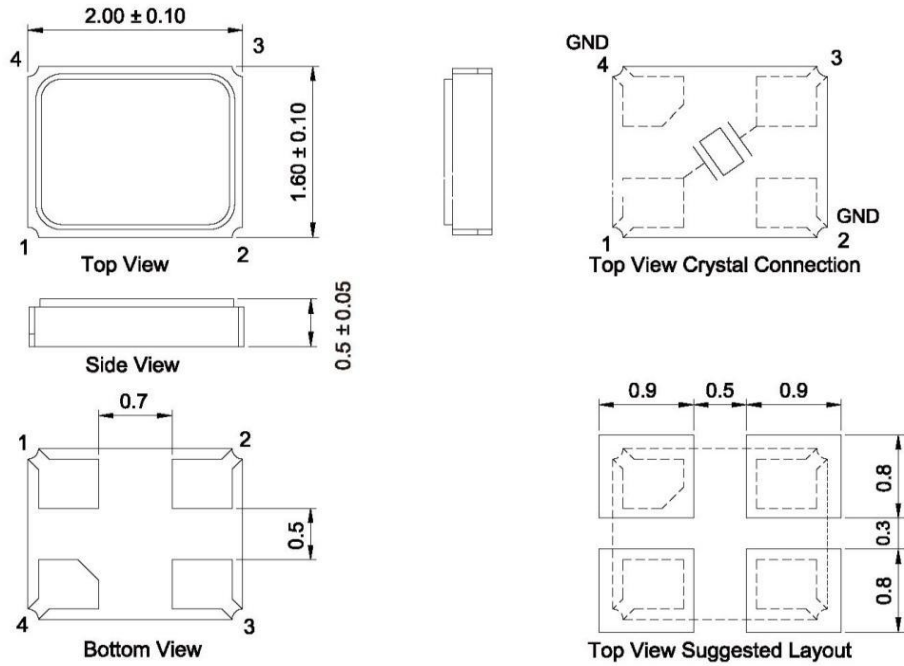

3 Marking specification

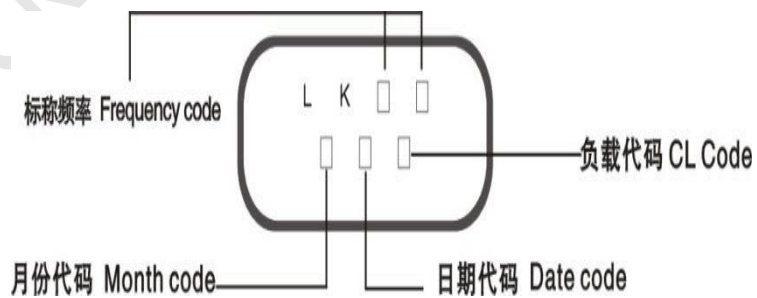

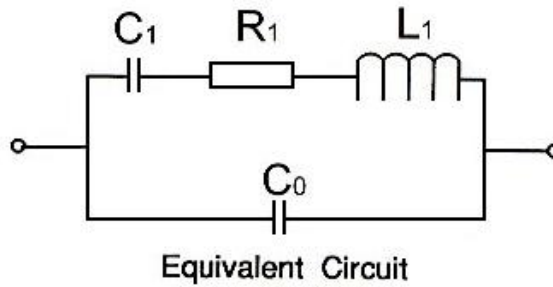
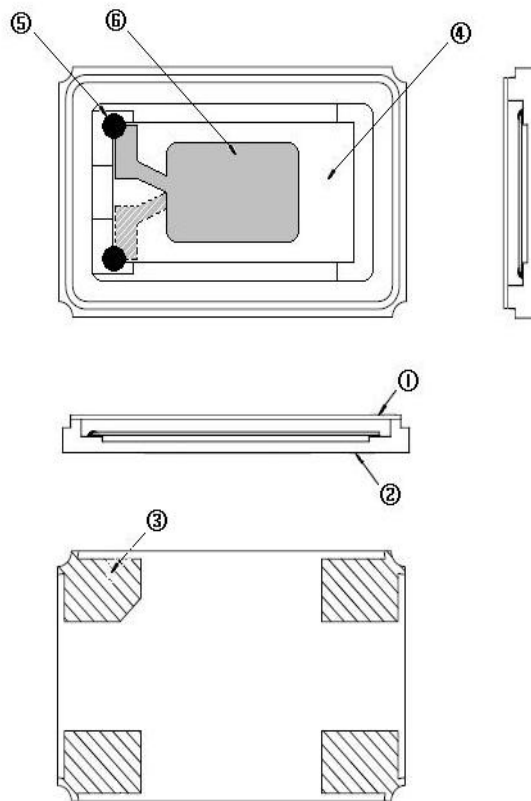
4. Equivalent Circuit

5. Structure drawing

NO	COMPONENTS	MATERIALS	QTY	FINISH / SPECIFICATIONS
1	Cap	Metal (Fe)	1	-
2	Base	Ceramic	1	Color black
3	PAD	Au	4	Tungsten metalize + Ni plating + Au plating
4	Crystal Blank	SiO ₂	1	-
5	Conductive Adhesive	Ag	4	Silicone
6	Electrode	Ag + Cr	2	-



LUCKI CM ELECTRONICS Co.,Ltd



6. Reliability Specification

	Item	Condition	Standard
1.	Drop characteristics	Free drop from 100cm height on a hard wooden board for 3 times. (Board is thickness more than 30 mm.)	Frequency change: $\leq \pm 5\text{ppm}$ Rr as specification
2	Mechanical shock	Device are shocked to half sine wave (1000g) three mutually perpendicular axes each 3 times	Frequency change: $\leq \pm 5\text{ppm}$ Rr as specification
3.	Shake characteristics	Shake frequency 10~55Hz, cyc1~2 minutes, swing 1.5mm, direction x/y/z, all 30 minutes, test after 2 hours.	Frequency change: $\leq \pm 5\text{ppm}$ Rr as specification
4.	Humidity characteristics	+40 \pm 2 $^{\circ}\text{C}$ & 90%~95% R.H. 250 hours	Frequency change: $\leq \pm 5\text{ppm}$ Rr as specification
5.	Low temperature characteristics	-40 \pm 2 $^{\circ}\text{C}$, 250 hours, put in room temperature, test after 1 hours.	Frequency change: $\leq \pm 5\text{ppm}$ Rr as specification
6.	High temperature characteristics	+85 \pm 2 $^{\circ}\text{C}$, 250 hours, put in room temperature, test after 1 hours.	Frequency change: $\leq \pm 5\text{ppm}$ Rr as specification
7.	Temperature cycling	-30 \pm 3 $^{\circ}\text{C}$ /30 \pm 3 min~+85 \pm 2 $^{\circ}\text{C}$ /30 \pm 3min, 5 cycles	Frequency change: $\leq \pm 5\text{ppm}$ Rr as specification
8.	Reflux examination	<p>1- Max 180 sec 2- Max 10 sec 3- Max 80 sec 4- Max 90 sec</p>	Frequency change: $\leq \pm 5\text{ppm}$ Rr as specification



LUCKI CM ELECTRONICS Co.,Ltd



7. Type & Reel

	HC-49SMD	7050	6035	5032	3225	2520	2016
W	24.00±0.30	16.00±0.05	12.00±0.05	12.00±0.05	8.00±0.05	8.00±0.05	8.00±0.05
E	1.75±0.10	1.75±0.10	1.75±0.10	1.75±0.10	1.75±0.10	1.75±0.10	1.75±0.10
F	11.5±0.10	7.5±0.10	5.5±0.10	5.5±0.10	3.5±0.05	3.5±0.05	3.5±0.05
T	0.40±0.05	0.35±0.05	0.35±0.05	0.30±0.05	0.25±0.03	0.25±0.03	0.25±0.03
P	12.00±0.10	8.00±0.10	8.00±0.10	8.00±0.10	4.00±0.05	4.00±0.05	4.00±0.05
P0	4.00±0.10	4.00±0.10	4.00±0.10	4.00±0.10	4.00±0.05	4.00±0.05	4.00±0.05
P2	2.00±0.10	2.00±0.10	2.00±0.10	2.00±0.10	2.00±0.05	2.00±0.05	2.00±0.05
D0	φ1.50±0.10	φ1.50±0.10	φ1.50±0.10	φ1.50±0.10	φ1.50±0.10	φ1.50±0.10	φ1.50±0.10
D1	φ1.50MIN	φ1.50MIN	φ1.50MIN	φ1.50MIN	φ1.00MIN	φ1.00MIN	φ1.00MIN
A0	4.60±0.10	5.40±0.10	3.90±0.10	3.50±0.10	2.70±0.10	2.4±0.10	2.00±0.10
K0	4.40±0.10	1.80±0.10	1.50±0.10	1.60±0.10	1.50±0.10	1.10±0.10	1.10±0.10
B0	14.20±0.15	7.40±0.10	6.40±0.10	5.20±0.10	3.50±0.05	2.90±0.05	2.4±0.05

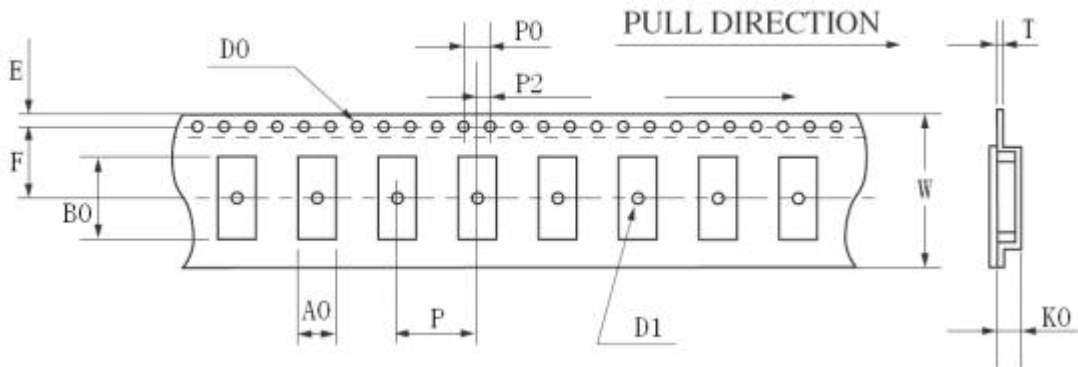

3000pc/reel

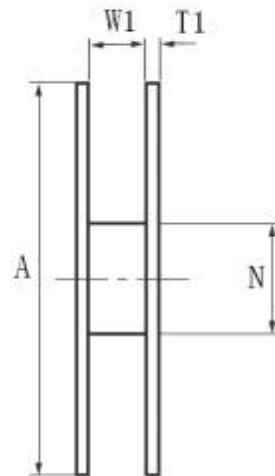
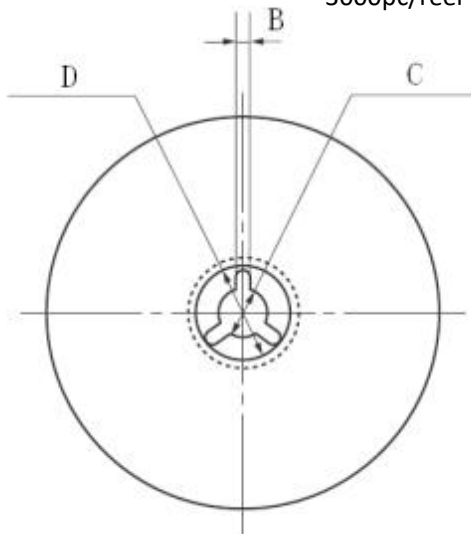



LUCKI CM ELECTRONICS Co.,Ltd



	HC-49SMD	7050	6035	5032	3225	2520	2016
A	$\phi 330 \pm 1.0$	$\phi 178 \pm 2.0$	$\phi 178 \pm 2.0$	$\phi 178 \pm 2.0$	$\phi 178 \pm 2.0$	$\phi 178 \pm 2.0$	$\phi 178 \pm 2.0$
B	2.30 ± 0.20	2.00 ± 0.50	2.00 ± 0.50	2.00 ± 0.50	2.50 ± 0.50	2.50 ± 0.50	2.50 ± 0.50
C	$\phi 13.5 \pm 0.20$	$\phi 13.2 \pm 0.20$	$\phi 13.2 \pm 0.20$	$\phi 13.2 \pm 0.20$	$\phi 13.5 \pm 0.20$	$\phi 13.5 \pm 0.20$	$\phi 13.5 \pm 0.20$
D	$\phi 21.5 \pm 0.20$	$\phi 20.0 \pm 0.50$	$\phi 20.0 \pm 0.50$	$\phi 20.0 \pm 0.50$	$\phi 56.8 \pm 0.50$	$\phi 56.8 \pm 0.50$	$\phi 56.8 \pm 0.50$
N	$\phi 100.0 \pm 0.5$	$\phi 60.5 \pm 1.0$	$\phi 60.5 \pm 1.0$	$\phi 60.5 \pm 1.0$	$\phi 60.5 \pm 1.0$	$\phi 60.5 \pm 1.0$	$\phi 60.5 \pm 1.0$
W1	24.5 ± 0.20	16.5 ± 0.20	12.5 ± 0.20	12.5 ± 0.20	9.4 ± 0.30	8.0 ± 0.30	8.0 ± 0.30
T1	2.30 ± 0.20	1.80 ± 0.20	1.80 ± 0.20	1.80 ± 0.20	1.40 ± 0.20	1.40 ± 0.20	1.40 ± 0.20

8. Packing Specification

