

Features

- Ultra low capacitance: 0.25pF typical(I/O/ to I/O)
- Low operating voltage: 3.3V
- Low clamping voltage
- Up to 4 lines protects
- Leadless flow-through package
- Complies with following standards:
 - IEC 61000-4-2 (ESD) immunity test
 - Air discharge: ±25kV
 - Contact discharge: ±20kV
 - IEC61000-4-5 (Lightning) 3A (8/20μs)

Mechanical Characteristics

- Package: DFN2510(2.5X1.0X0.5mm)
- Ultra low leakage: nA level
- Case Material: “Green” Molding Compound.
- Moisture Sensitivity: Level 3 per J-STD-020
- Terminal Connections: See Diagram Below
- Shipping Qty :10000/7Inch Tape & Reel

Applications

- HDMI 1.4& 2.0, USB 2.0 & 3.0 and MDDI ports
- Monitors and flat panel displays
- Set-top box and Digital TV
- Video graphics cards
- Digital Video Interface (DVI)
- Notebook Computers

Dimensions and Pin Configuration

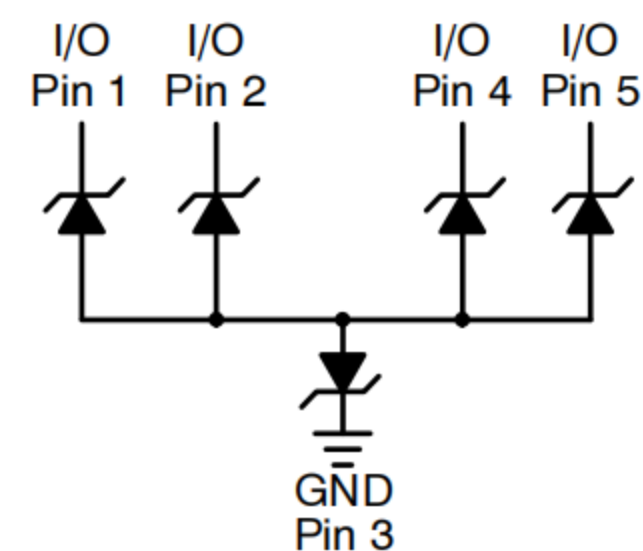
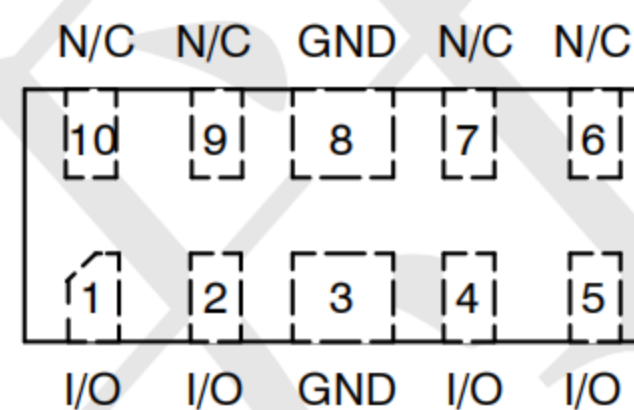
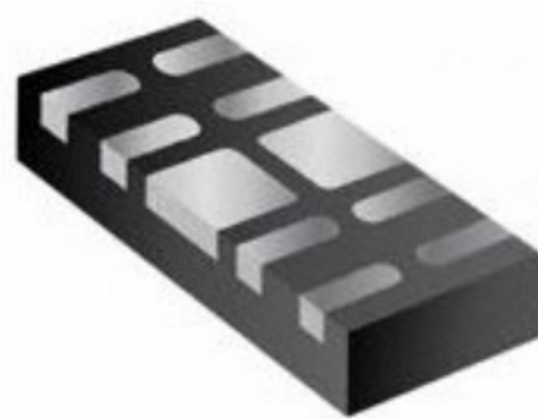

Marking:

7MP

Absolute Maximum Ratings (T_{amb}=25°C unless otherwise specified)

Parameter	Symbol	Value	Unit
Peak Pulse Power (8/20μs)	Ppk	60	W
Peak Pulse Current (8/20μs)	Ipp	3	A
ESD per IEC 61000-4-2 (Air)	VESD	±20	kV
ESD per IEC 61000-4-2 (Contact)		±15	
Operating Temperature Range	TJ	-55 to +125	°C
Storage Temperature Range	Tstg	-55 to +150	°C

Electrical Characteristics (T_A=25°C unless otherwise specified)

Parameter	Symbol	Min	Typ	Max	Unit	Test Condition
Reverse Working Voltage	VRWM			3.3	V	
Breakdown Voltage	VBR	6	7.5	8.5	V	IT = 1mA
Reverse Leakage Current	IR			0.2	μA	VRWM = 3.3V
Clamping Voltage	Vc			9	V	I _{PP} = 1A (8 x 20μs pulse)
	Vc			18	V	I _{PP} = 3A (8 x 20us pulse)
Clamping Voltage	Vc			7.5	V	I _{PP} = 1A (TLP) IO to GND
	Vc			9.5	V	I _{PP} = 5A (TLP) GND to IO
	Vc			7.5	V	I _{PP} = 1A (TLP) IO to GND
	Vc			9.5	V	I _{PP} = 5A (TLP) GND to IO
Junction Capacitance	CJ		0.25		pF	VR = 0V, f = 1MHz

Typical Performance Characteristics ($T_A=25^\circ\text{C}$ unless otherwise Specified)

Fig1. 8/20 μs Pulse Waveform

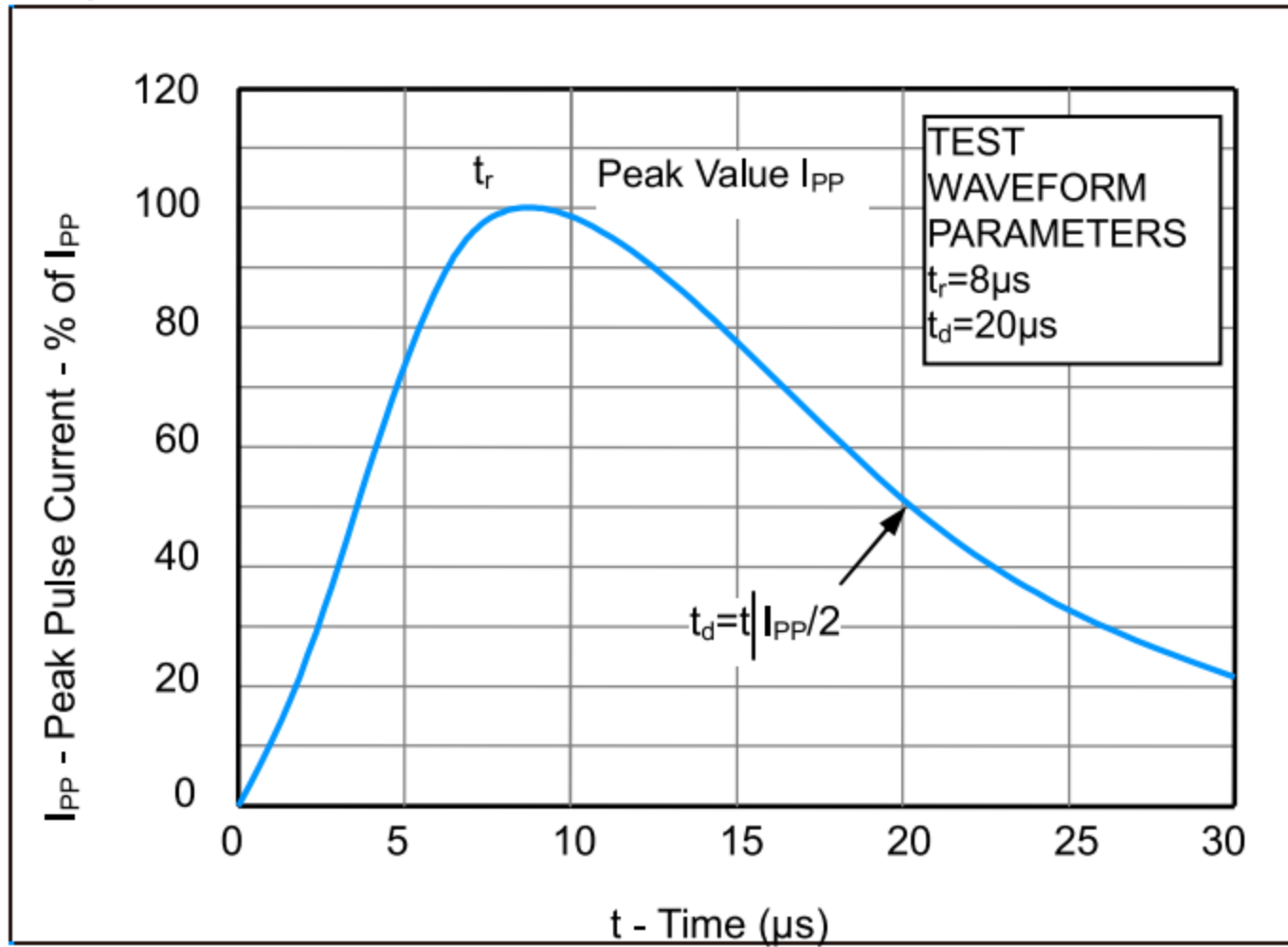

Fig2. ESD Pulse Waveform (according to IEC 61000-4-2)

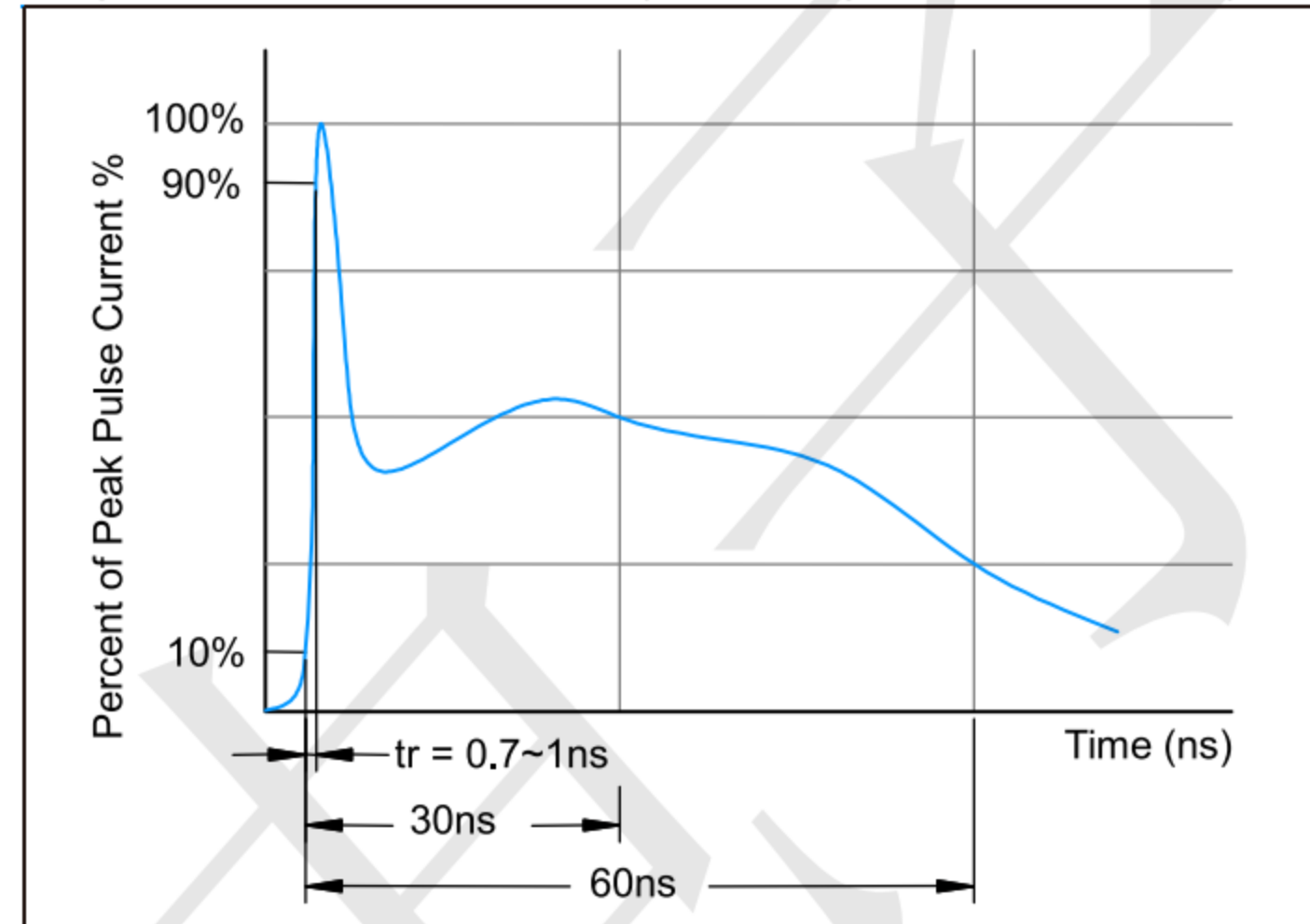
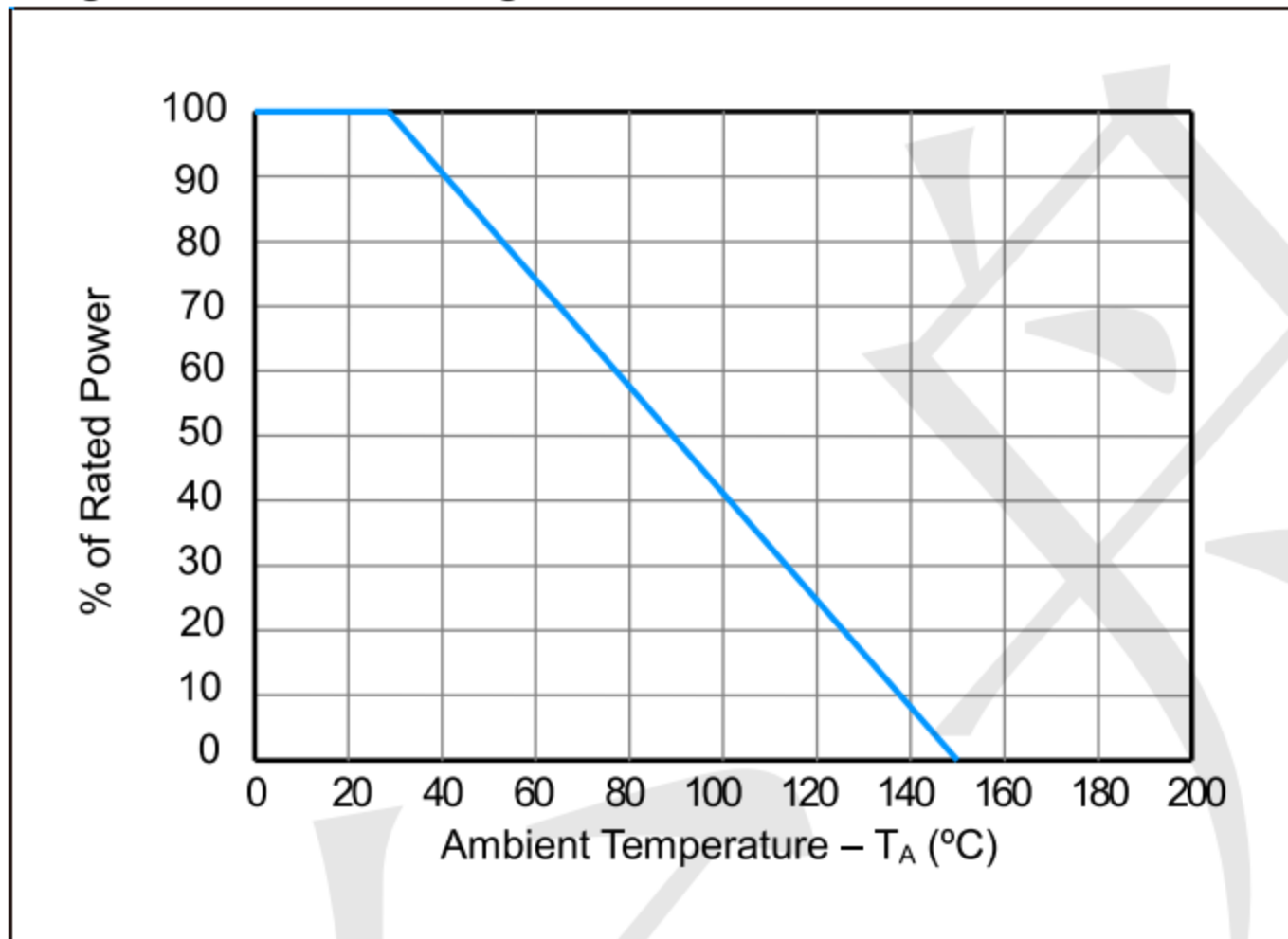
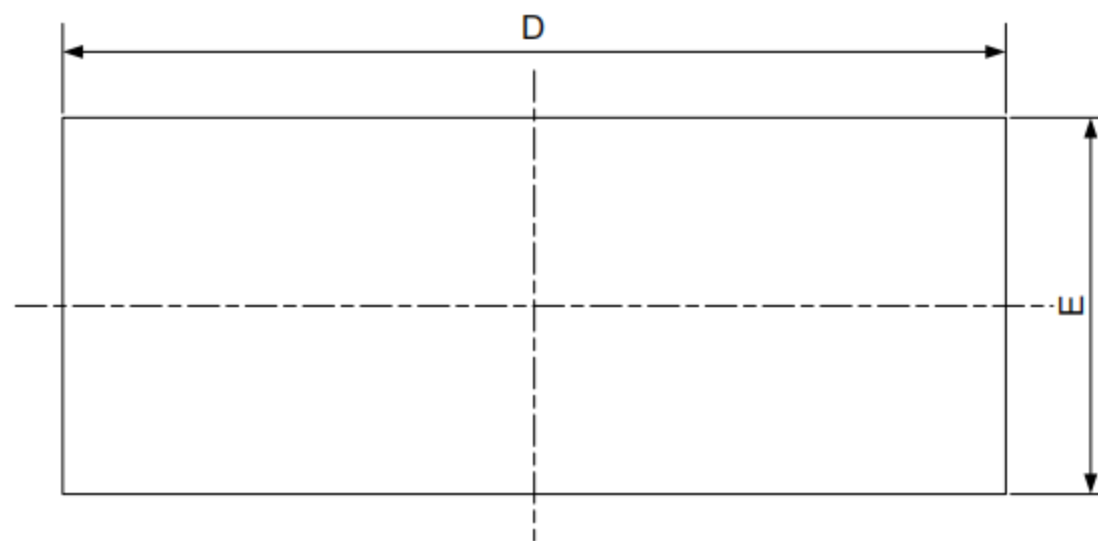

Fig3. Power Derating Curve



DFN2510-10 Package Outline Drawing



TOP VIEW

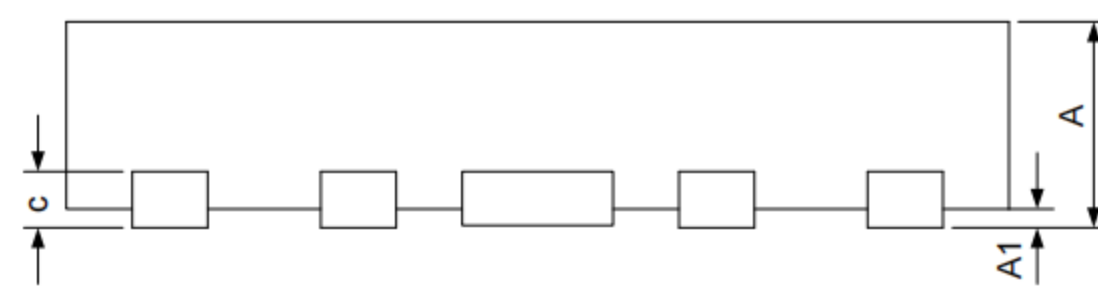

SIDE VIEW

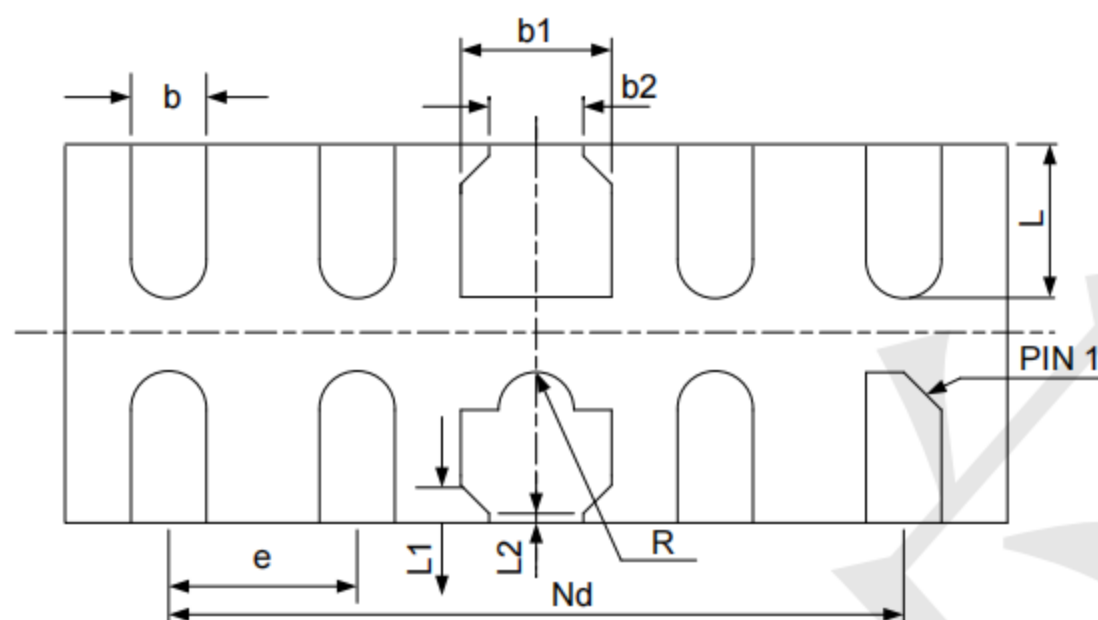

BOTTOM VIEW

SYM	DIMENSIONS					
	MILLIMETERS			INCHES		
	MIN	NOM	MAX	MIN	NOM	MAX
A	0.45	0.50	0.55	0.018	0.020	0.022
A1	0.00	0.02	0.05	0.000	0.001	0.002
b	0.15	0.20	0.25	0.006	0.008	0.010
b1	0.35	0.40	0.45	0.014	0.016	0.018
b2	0.20	0.25	0.30	0.008	0.010	0.012
c	0.10	0.15	0.20	0.004	0.006	0.008
D	2.45	2.50	2.55	0.098	0.100	0.102
e	0.50BSC			0.020BSC		
Nd	2.00BSC			0.080BSC		
E	0.95	1.00	1.05	0.038	0.040	0.042
L	0.35	0.40	0.45	0.014	0.016	0.018
L1	0.075REF			0.003REF		
L2	0.050REF			0.002REF		
h	0.08	0.12	0.15	0.003	0.005	0.006
R	0.05	0.10	0.15	0.002	0.004	0.006

Suggested Land Pattern

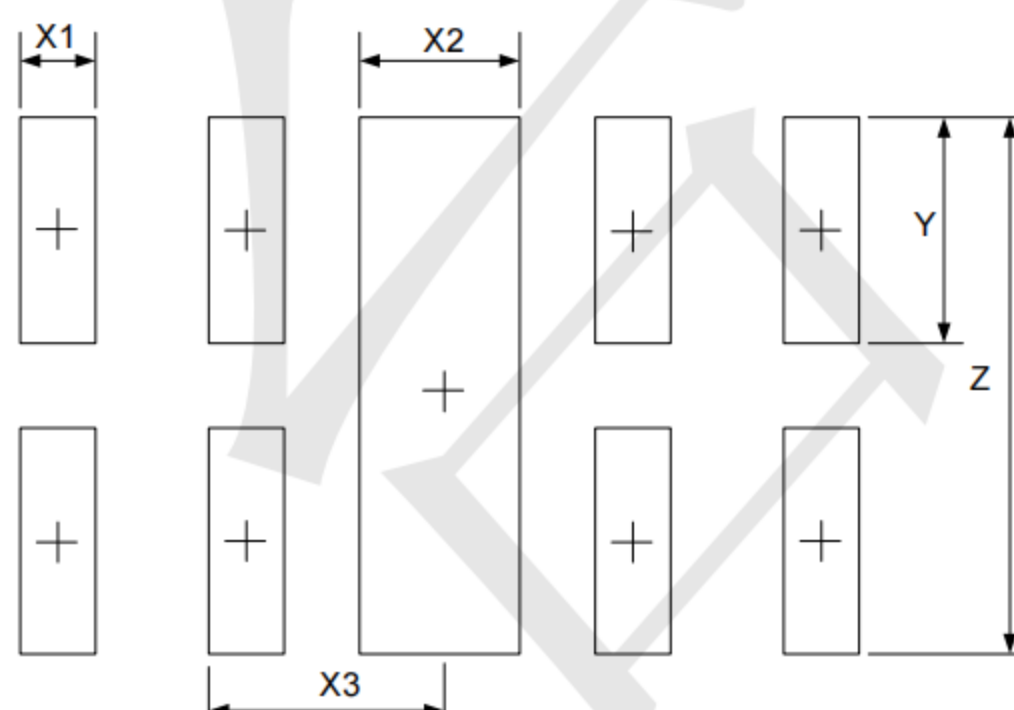

SYM	DIMENSIONS	
	MILLIMETERS	INCHES
X1	0.200	0.008
X2	0.400	0.016
X3	0.500	0.020
Y	0.600	0.024
Z	1.400	0.056