

SOT-23 Plastic-Encapsulate MOSFETS

BSS123 N Channel MOSFET

$V_{(BR)DSS}$	$R_{DS(on)MAX}$	I_D
100V	6Ω@10V	0.17A
	10Ω@4.5V	

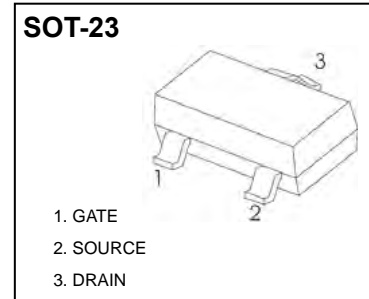

FEATURE

- Surface Mount Package
- High Density Cell Design for Extremely Low $R_{DS(ON)}$
- Voltage Controlled Small Signal Switch
- Rugged and Reliable

APPLICATION

- Small Servo Motor Controls
- Power MOSFET Gate Drivers
- Switching Application

MARKING

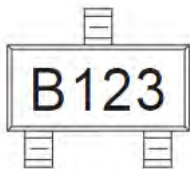

Equivalent Circuit

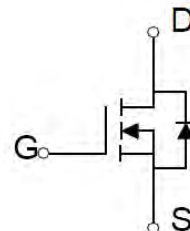

ABSOLUTE MAXIMUM RATINGS ($T_a=25^{\circ}C$ unless otherwise noted)

Parameter	Symbol	Value	Unit
N-MOSFET			
Drain-Source Voltage	V_{DS}	100	V
Gate-Source Voltage	V_{GS}	±20	V
Continuous Drain Current (note 1)	I_D	0.17	A
Pulsed Drain Current ($t_p=10\mu s$)	I_{DM}	0.68	A
Continous Source-Drain Diode Current	I_S	0.17	A
Power Dissipation	P_D	0.35	W
Thermal Resistance from Junction to Ambient (note 1)	$R_{\theta JA}$	357	$^{\circ}C/W$
Junction Temperature	T_J	150	$^{\circ}C$
Storage Temperature	T_{STG}	-55~+150	$^{\circ}C$
Lead Temperature for Soldering Purposes(1/8" from case for 10 s)	T_L	260	$^{\circ}C$

MOSFET ELECTRICAL CHARACTERISTICS

$T_a=25\text{ }^\circ\text{C}$ unless otherwise specified

Parameter	Symbol	Test Condition	Min	Typ	Max	Unit
STATIC CHARACTERISTICS						
Drain-source breakdown voltage	$V_{(BR)DSS}$	$V_{GS} = 0V, I_D = 250\mu A$	100			V
Zero gate voltage drain current	I_{DSS}	$V_{DS} = 100V, V_{GS} = 0V$			1	μA
		$V_{DS} = 20V, V_{GS} = 0V$			10	nA
Gate-body leakage current	I_{GSS}	$V_{GS} = \pm 20V, V_{DS} = 0V$			± 50	nA
Gate threshold voltage (note 2)	$V_{GS(th)}$	$V_{DS} = V_{GS}, I_D = 250\mu A$	1		2.8	V
Drain-source on-resistance(note 2)	$R_{DS(on)}$	$V_{GS} = 4.5V, I_D = 0.17A$			10	Ω
		$V_{GS} = 10V, I_D = 0.17A$			6	Ω
Forward tranconductance(note 2)	g_{FS}	$V_{DS} = 10V, I_D = 170mA$	80			mS
Diode forward voltage	V_{SD}	$I_S = 340mA, V_{GS} = 0V$			1.3	V
DYNAMIC CHARACTERISTICS (note 4)						
Input Capacitance	C_{iss}	$V_{DS} = 25V, V_{GS} = 0V, f = 1MHz$		29	60	pF
Output Capacitance	C_{oss}			10	15	pF
Reverse Transfer Capacitance	C_{rss}			2	6	pF
SWITCHING CHARACTERISTICS (note 3,4)						
Turn-on delay time	$t_{d(on)}$	$V_{GS} = 10V, V_{DD} = 30V, I_D = 2.8A, R_{GEN} = 50\ \Omega$			8	ns
Turn-on rise time	t_r				8	ns
Turn-off delay time	$t_{d(off)}$				13	ns
Turn-off fall time	t_f				16	ns
Total Gate Charge	Q_g	$V_{DS} = 10V, I_D = 0.22A, V_{GS} = 10V$		1.4	2	nC
Gate-Source Charge	Q_{gs}			0.15	0.25	nC
Gate-Drain Charge	Q_{gd}			0.2	0.4	nC

Notes :

1. Surface mounted on FR4 board using the minimum recommended pad size.
2. Pulse Test : Pulse width=300 μ s, duty cycle \leq 2%.
3. Switching characteristics are independent of operating junction temperature.
4. Granted by design, not subject to producing.

Typical Characteristics

Output Characteristics

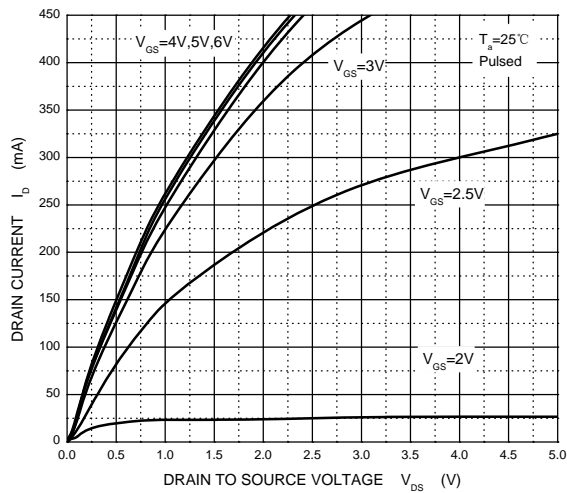

Transfer Characteristics

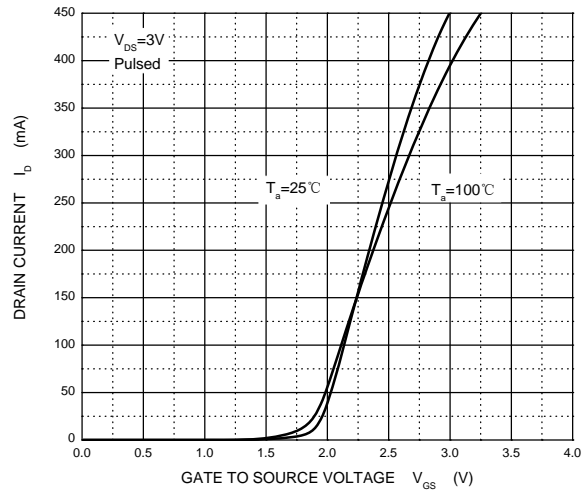

$R_{DS(ON)}$ — I_D

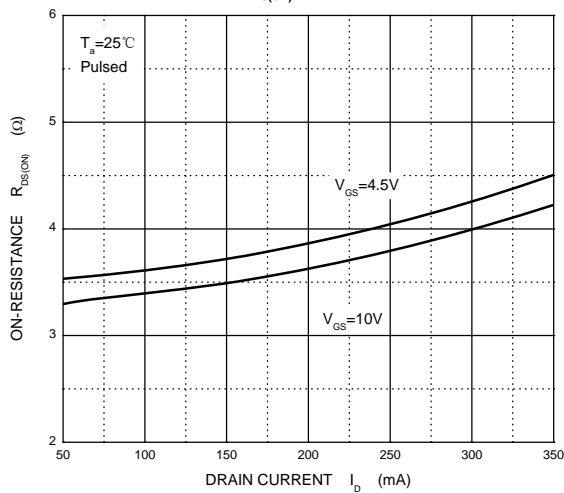

$R_{DS(ON)}$ — V_{GS}

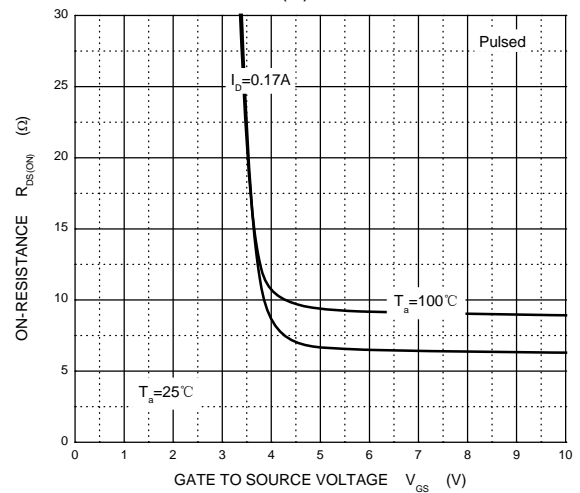

I_S — V_{SD}

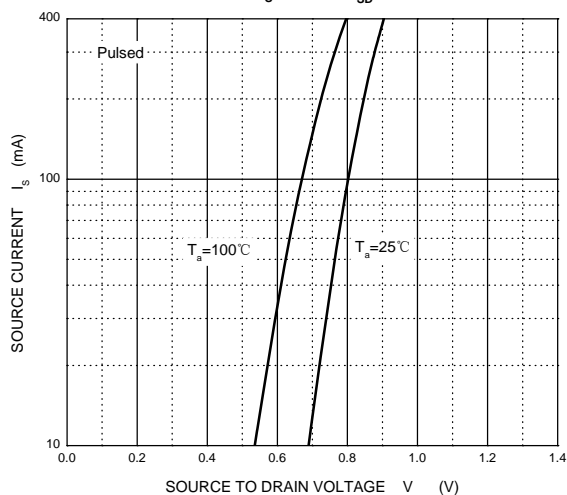

Threshold Voltage

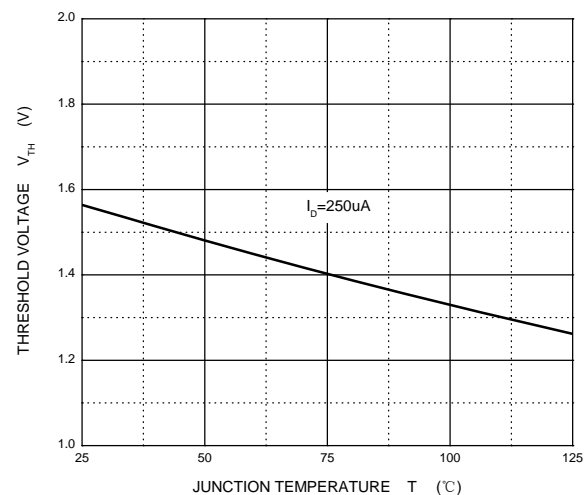

PACKAGE OUTLINE

SOT-23

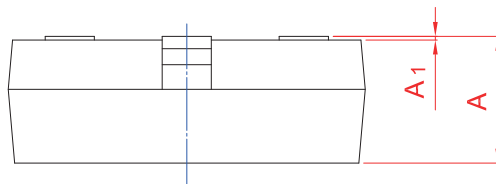
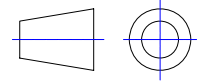
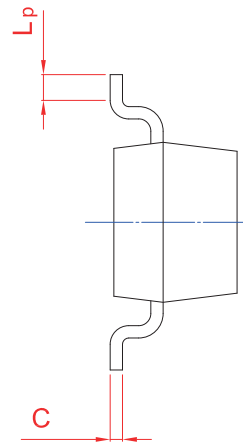
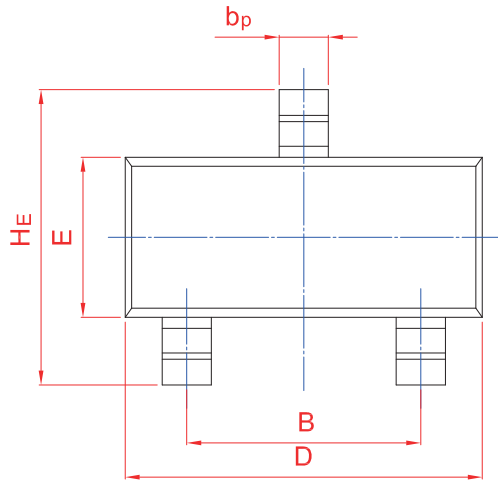

UNIT	A	B	b _p	C	D	E	H _E	A ₁	L _p
mm	1.40	2.04	0.51	0.19	3.10	1.65	3.00	0.100	0.50
	0.89	1.78	0.30	0.08	2.70	1.20	2.20	0.013	0.20