

» Features

- 56Watts peak pulse power ($t_p = 8/20\mu s$)
- Uni-directional configurations
- Solid-state silicon-avalanche technology
- Low clamping voltage
- Low leakage current
- Complies with following standards:
 - IEC 61000-4-2 (ESD) immunity test
 - Air discharge: $\pm 25KV$
 - Contact discharge: $\pm 20KV$
 - IEC61000-4-4 (EFT) 40A (5/50ns)
 - IEC61000-4-5 (Lightning) 4A (8/20us)

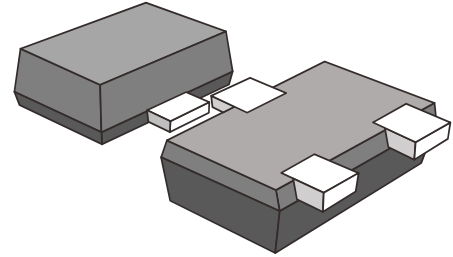

» Applications

- Digital TV
- Set-top box and Digital TV
- Mobile Phones and Accessories
- Cellular Handsets and Accessories

» Mechanical Data

- Package: SOT-723
- UL Flammability Classification Rating 94V-0
- Packaging: Tape and Reel
- RoHS/WEEE Compliant

» Schematic & PIN Configuration

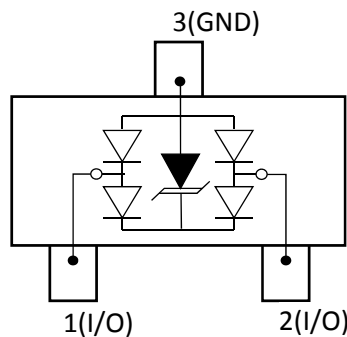

SOT-723

» Absolute Maximum Ratings

Parameter	Symbol	Value	Units
Reverse Working Voltage	V_{RWM}	5	V
Peak Pulse Power (8/20 μ s)	P_{PP}	56	W
Peak Pulse Current (8/20 μ s)	I_{PP}	4	A
ESD per IEC 61000-4-2 (Air)	$V_{ESD-Air}$	25	KV
ESD per IEC 61000-4-2 (Contact)	$V_{ESD-Contact}$	20	KV
Lead Soldering Temperature	T_L	260(10s)	$^{\circ}$ C
Operating Temperature Range	T_J	-55 to 125	$^{\circ}$ C
Storage Temperature Range	T_{STG}	-55 to 150	$^{\circ}$ C

» Electrical Characteristics

Parameter	Symbol	Conditions	Min	Typ	Max	Units
Breakdown Voltage	V_{BR}	$I_T = 1mA$	6			V
Reverse Leakage Current	I_R	$V_{RWM} = 5V$		0.001	0.1	μ A
Clamping Voltage	V_C	$I_{PP} = 4A$, 8/20 μ s		12	14	V
Junction Capacitance between I/O pins	C_O	$V_{DC} = 0V$, $f = 1MHz$		0.25	0.35	pF
Junction Capacitance between I/O pin and GND	C_J	$V_{DC} = 0V$, $f = 1MHz$		0.45	0.6	pF

» Electrical Parameters

Symbol	Definition
I_{PP}	Maximum Reverse Peak Pulse Current
V_C	Clamping Voltage @ I_{PP}
V_{RWM}	Working Peak Reverse Voltage
I_R	Maximum Reverse Leakage Current @ V_{RWM}
V_{BR}	Breakdown Voltage @ I_T
I_T	Test Current

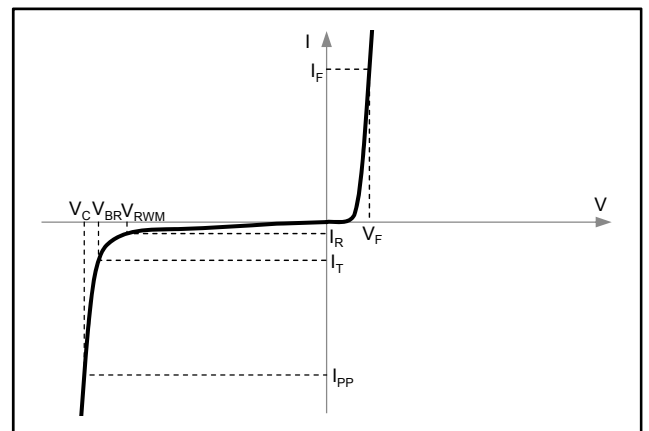

» Typical Characteristics

Fig.1 - Peak Pulse Power Rating

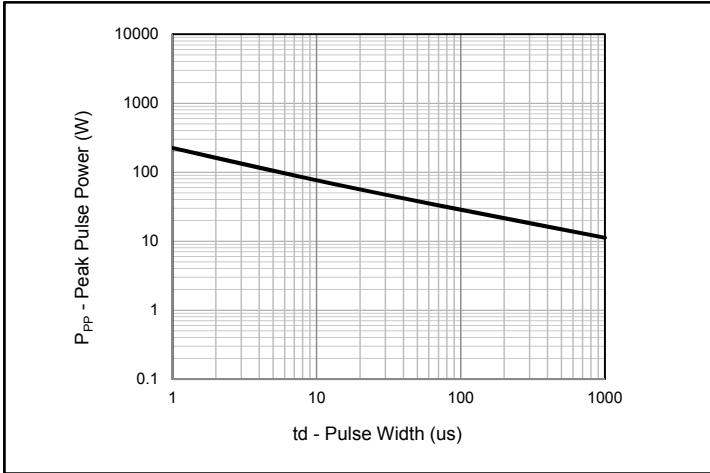

Fig.2 - Pulse Derating Curve

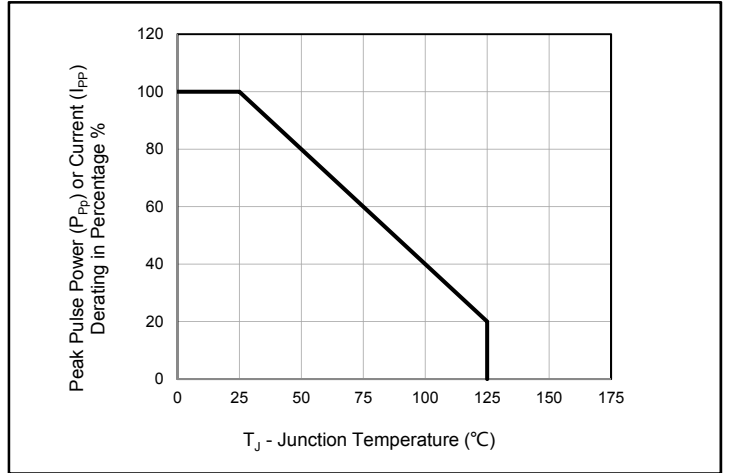

Fig.3 - 8/20us Pulse Waveform

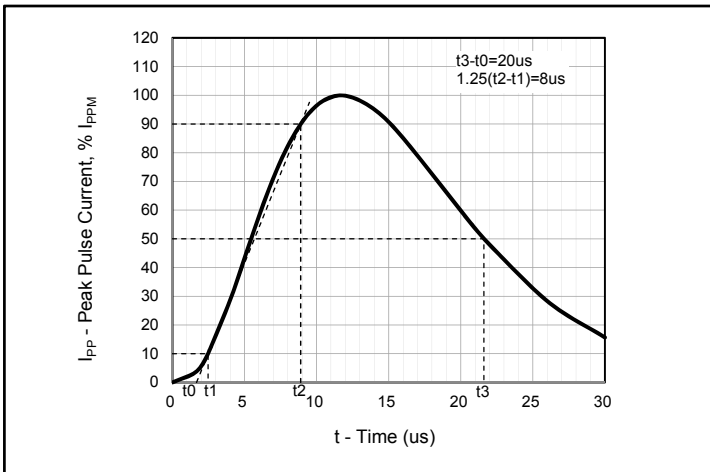
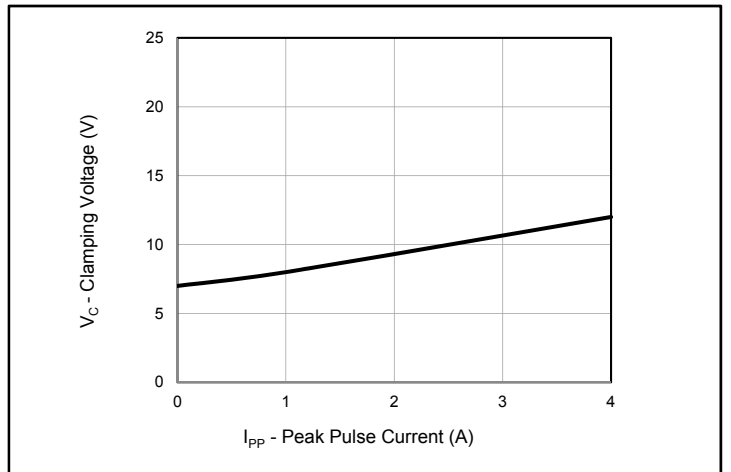
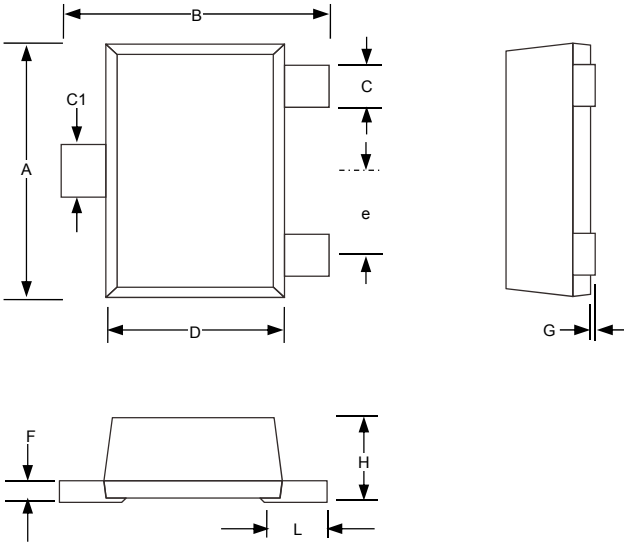

Fig.4 - Clamping Voltage



» Outline Drawing



SOT-723						
SYMBOL	Millimeters			Inches		
	MIN	NOM	MAX	MIN	NOM	MAX
A	1.15	1.2	1.25	0.045	0.047	0.049
B	1.15	1.2	1.25	0.045	0.047	0.049
C	0.15	0.2	0.25	0.006	0.008	0.01
D	0.75	0.8	0.85	0.03	0.031	0.033
e		0.4			0.016	
F	0.08	0.1	0.15	0.003	0.004	0.006
G			0.05			0.002
C1	0.2	0.25	0.3	0.008	0.01	0.012

» Marking

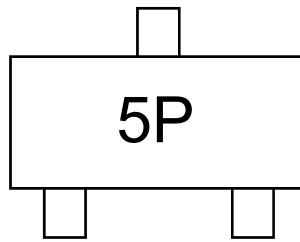

Marking Code: 5P

» Ordering Information

Order Code	Package	Base Quantity	Delivery Mode
ESD7L5.0DT5G-N	SOT-723	10000	Tape and Reel