

SMD Common Mode Choke

BWCU_02 Series For USB 2.0, IE EE1394b, LVDS Applications



A full series of common mode choke is designed for excellent noise attenuation with compact sizing for use in wide range of applications. Both standard series and custom designs are available.

Features

- RoHS Compliant
- Miniature SMD type common mode filter for fully automated assembly
- Wide impedance range (30Ω ~ 2200Ω) for noise suppression
- Excellent solderability

Applications

- USB line for personal computers and peripheral
- IEEE 1394 line for personal computers, DVC, STB
- LVDS, panel line for liquid display panels, graph card, etc.

Product Identification

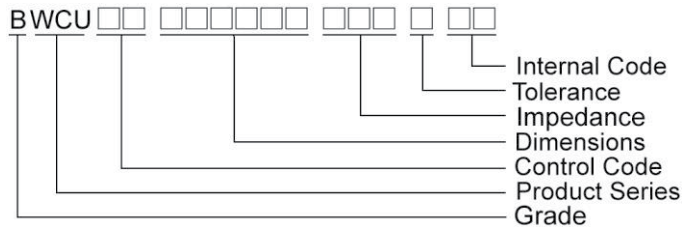

Shape and Dimensions

BWCU00160811/ 121008/ 321619

BWCU00201212

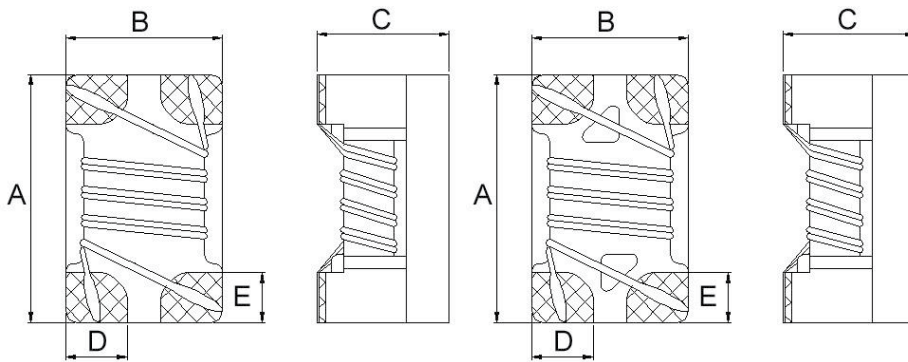

Recommended Pattern

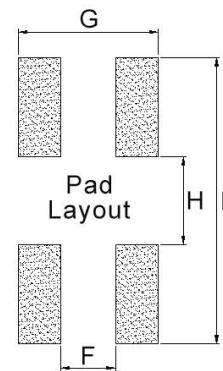

Dimensions in mm

TYPE	A	B	C	D	E	F	G	H	I
BWCU00160811	1.60±0.2	0.80±0.2	1.10±0.2	0.25	0.33	0.25	0.75	0.61	2.29
BWCU00121008	1.25±0.2	1.00±0.2	0.8±0.1	0.32	0.33	0.36	1.00	0.59	1.75
BWCU00201212	2.05±0.2	1.25±0.2	1.20±0.2	0.50	0.40	0.50	1.27	0.80	2.60
BWCU00321619	3.20±0.2	1.60±0.2	1.90±0.2	0.50	0.60	0.40	1.60	1.60	3.70

SMD Common Mode Choke

BWCU_02 Series For USB 2.0, IE EE1394b, LVDS Applications

Shape and Dimensions

BWCU00231512

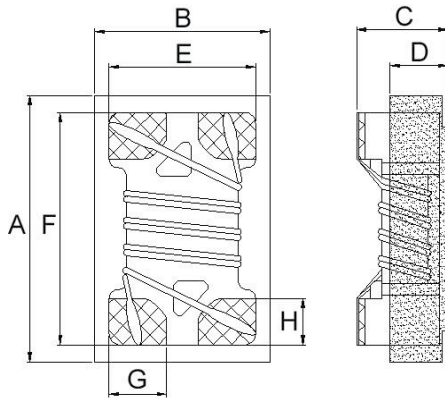

Recommended Pattern

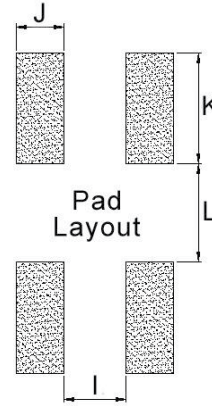

Dimensions in mm

TYPE	A	B	C	D	E	F	G	H	I	J	K	L
BWCU00231512	2.29 ⁺⁰	1.52 ⁺⁰	1.20 ⁺⁰	0.5	1.27	2.03	0.5	0.40	0.5	0.38	0.9	0.8

SMD Common Mode Choke

BWCU_02 Series For USB 2.0, IE EE1394b, LVDS Applications



Electrical Characteristics

Part Number	Impedance (Ω)	Tolerance (±%)	Test Frequency (MHz)	RDC (Ω) Max	I _{rms} (mA) Max	Rated Voltage (Vdc)	Withstand Voltage (Vdc)	Insulation Resistance (MΩ) Min
BWCU00160811250M02	25	20,25	100	0.077	500	50	125	10
BWCU00160811600M02	60	20,25	100	0.109	500	50	125	10
BWCU00160811900M02	90	20,25	100	0.142	500	50	125	10
BWCU00160811121M02	120	20,25	100	0.160	500	50	125	10
BWCU00160811141M02	140	20,25	100	0.174	500	50	125	10
BWCU00160811221M02	220	20,25	100	0.209	500	50	125	10

Note: When ordering, please specify tolerance code. Tolerance: M=±20% , Y=±25%

- Operating temperature range - 40°C ~ 105°C(Including self - temperature rise)
- rms for 20°C rise from 25°C ambient
- Measure Equipment :
 Z : Agilent HP4287A+Agilent 16197A
 RDC : HP4338B or Chroma 16502 (Single Wire Test Value)
 I_{rms} : HP4284A+HP42841A/HP4285A+HP42841A
 Insulation Resistance : Agilent HP4339B

Test Instruments : HP4287A Material/Impedance Analyzer

Typical Impedance vs. Frequency

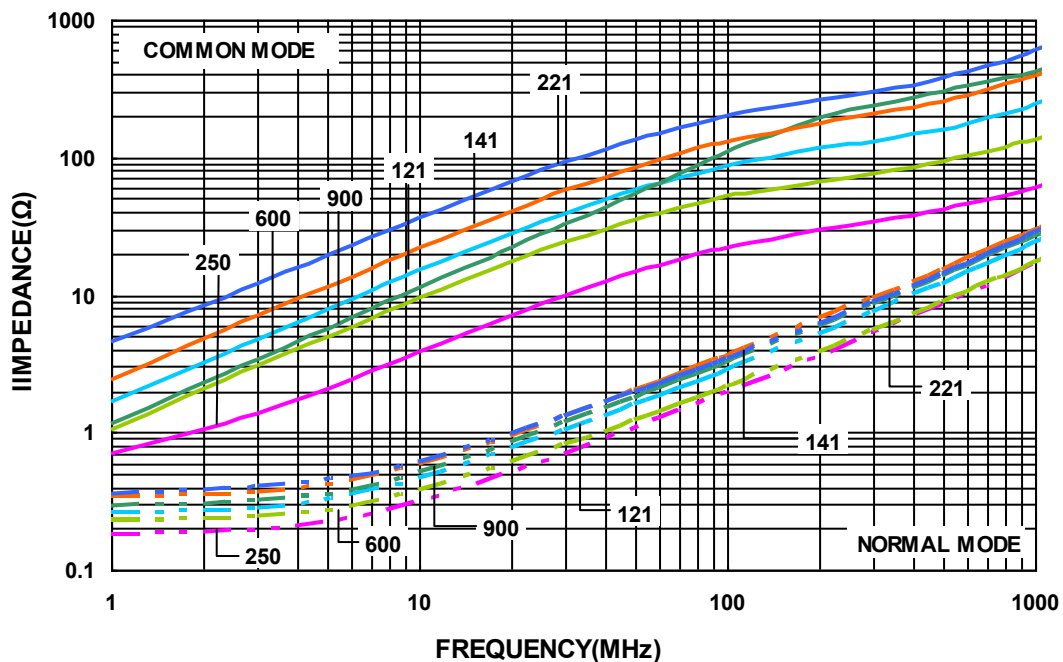

SMD Common Mode Choke

BWCU_02 Series For USB 2.0, IE EE1394b, LVDS Applications



Electrical Characteristics

Part Number	Impedance (Ω)	Tolerance (±%)	Test Frequency (MHz)	RDC (Ω) Max	IDC (mA)	Rated Voltage (Vdc)	Withstand Voltage (Vdc)	Insulation Resistance (MΩ) Min
BWCU00121008250T02	25	30	100	0.30	400	50	125	100
BWCU00121008600M02	60	20	100	0.40	300	50	125	100
BWCU00121008670M02	67	20	100	0.25	300	50	125	100
BWCU00121008900M02	90	20	100	0.30	250	50	125	100
BWCU00121008121M02	120	20	100	0.40	200	50	125	100
BWCU00121008161M02	160	20	100	0.43	160	50	125	100
BWCU00121008201M02	200	20	100	0.80	120	50	125	100
BWCU00121008331Y02	330	25	100	1.30	100	50	125	100

Note: When ordering, please specify tolerance code. Tolerance: M=±20% , Y=±25% , T=±30%

- Operating temperature range - 40°C ~ 105°C(Including self - temperature rise)
- IDC for Inductance drop 10% from its value without current
- Measure Equipment :
 Z : Agilent HP4287A+Agilent 16197A
 RDC : Chroma 16502 (Single Wire Test Value)
 IDC : HP4284A+HP42841A/HP4285A+HP42841A
 Insulation Resistance : Agilent HP4339B

Test Instruments : HP4287A Material/Impedance Analyzer

Typical Impedance vs. Frequency

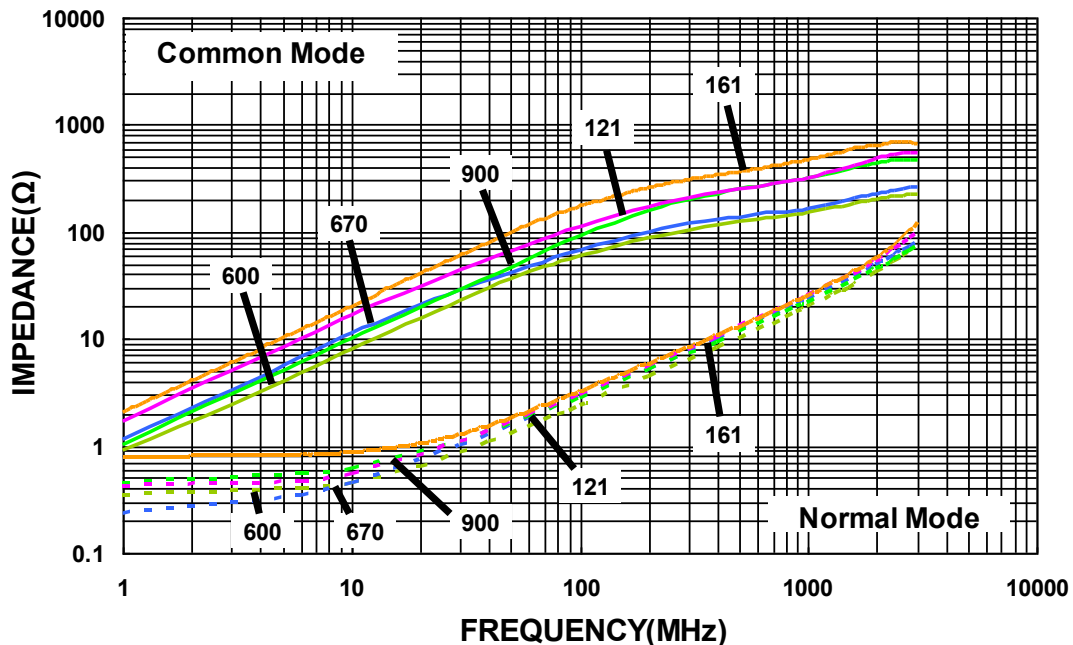

SMD Common Mode Choke

BWCU_02 Series For USB 2.0, IE EE1394b, LVDS Applications



Electrical Characteristics

Part Number	Impedance (Ω)	Tolerance ($\pm\%$)	Test Frequency (MHz)	RDC (Ω) Max	IDC (mA)	Rated Voltage (Vdc)	Withstand Voltage (Vdc)	Insulation Resistance (M Ω) Min
BWCU00201212300M02	30	20	100	0.20	450	50	125	10
BWCU00201212670M02	67	20	100	0.25	400	50	125	10
BWCU00201212750M02	75	20	100	0.30	360	50	125	10
BWCU00201212900M02	90	20	100	0.35	330	50	125	10
BWCU00201212121M02	120	20	100	0.30	400	50	125	10
BWCU00201212161M02	160	20	100	0.35	350	50	125	10
BWCU00201212181M02	180	20	100	0.35	330	50	125	10
BWCU00201212201M02	200	20	100	0.35	330	50	125	10
BWCU00201212221M02	220	20	100	0.35	310	50	125	10
BWCU00201212261M02	260	20	100	0.40	300	50	125	10
BWCU00201212301M02	300	20	100	0.40	290	50	125	10
BWCU00201212361M02	360	20	100	0.45	280	50	125	10
BWCU00201212371M02	370	20	100	0.45	280	50	125	10
BWCU00201212501M02	500	20	100	0.55	170	50	125	10
BWCU00201212671M02	670	20	100	0.60	140	50	125	10
BWCU00201212801M02	800	20	100	0.88	300	50	125	10
BWCU00201212901M02	900	20	100	0.60	80	50	125	10

Note: When ordering, please specify tolerance code. Tolerance: M=±20%

- Operating temperature range - 40°C ~ 105°C(Including self - temperature rise)
- IDC for Inductance drop 10% from its value without current
- Measure Equipment :
 - Z : Agilent HP4287A+Agilent 16197A
 - RDC : Chroma 16502 (Single Wire Test Value)
 - IDC : HP4284A+HP42841A/HP4285A+HP42841A
 - Insulation Resistance : Agilent HP4339B

SMD Common Mode Choke

BWCU_02 Series For USB 2.0, IE EE1394b, LVDS Applications



Test Instruments : HP4291A Material/Impedance Analyzer

Typical Impedance vs. Frequency

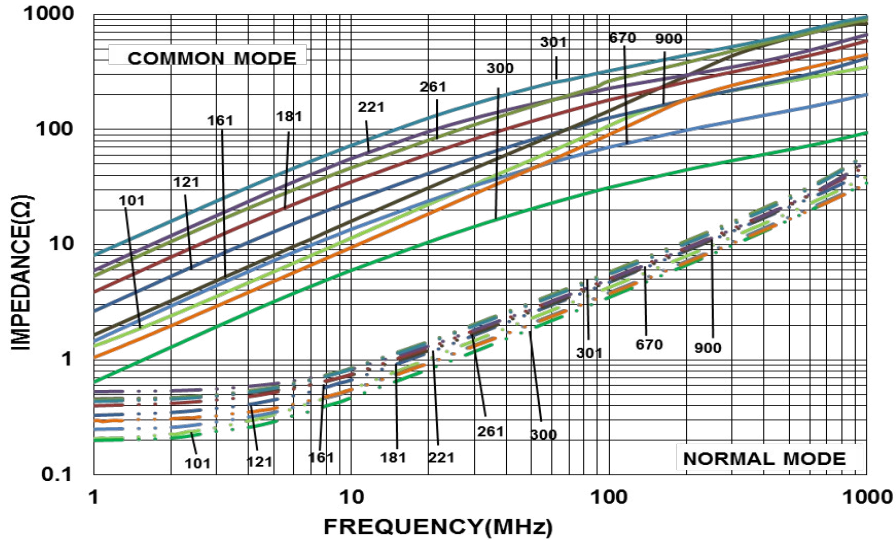

Electrical Characteristics

Part Number	Impedance (Ω)	Tolerance (±%)	Test Frequency (MHz)	RDC (Ω) Max	IDC (mA)	Rated Voltage (Vdc)	Withstand Voltage (Vdc)	Insulation Resistance (MΩ) Min
BWCU00321619900M02	90	20	100	0.3	370	50	125	10
BWCU00321619121M02	120	20	100	0.3	370	50	125	10
BWCU00321619161M02	160	20	100	0.4	340	50	125	10
BWCU00321619221M02	220	20	100	0.4	320	50	125	10
BWCU00321619261M02	260	20	100	0.5	310	50	125	10
BWCU00321619601M02	600	20	100	0.8	260	50	125	10
BWCU00321619102M02	1000	20	100	1.0	230	50	125	10
BWCU00321619222M02	2200	20	100	1.2	200	50	125	10

Note: When ordering, please specify tolerance code. Tolerance: M=±20%

- Operating temperature range - 40°C ~ 105°C(Including self - temperature rise)
- IDC for Inductance drop 10% from its value without current
- Measure Equipment :
 Z : Agilent HP4287A+Agilent 16197A
 RDC : Chroma 16502 (Single Wire Test Value)
 IDC : HP4284A+HP42841A/HP4285A+HP42841A
 Insulation Resistance : Agilent HP4339B

SMD Common Mode Choke

BWCU_02 Series For USB 2.0, IE EE1394b, LVDS Applications



Test Instruments : HP4291A Material/Impedance Analyzer

Typical Impedance vs. Frequency

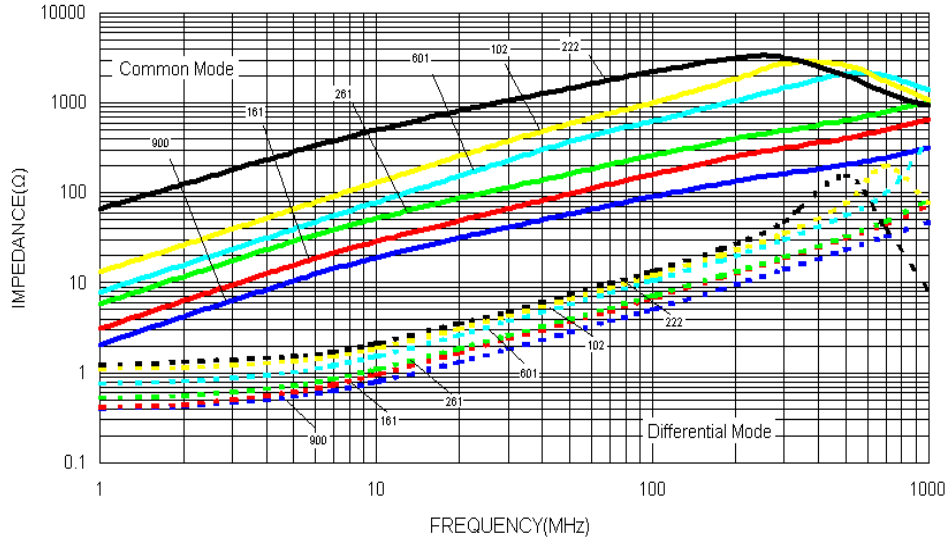

Electrical Characteristics

Part Number	Impedance (Ω)	Tolerance (±%)	Test Frequency (MHz)	RDC (Ω) Max	IDC (mA)	Rated Voltage (Vdc)	Withstand Voltage (Vdc)	Insulation Resistance (MΩ) Min
BWCU00231512300M02	30	20	100	0.20	1300	50	125	10
BWCU00231512420M02	42	20	100	0.20	1300	50	125	10
BWCU00231512670M02	67	20	100	0.25	1200	50	125	10
BWCU00231512900M02	90	20	100	0.27	1000	50	125	10
BWCU00231512121M02	120	20	100	0.30	900	50	125	10
BWCU00231512181M02	180	20	100	0.40	700	50	125	10
BWCU00231512261M02	260	20	100	0.60	700	50	125	10

Note: When ordering, please specify tolerance code. Tolerance: M=±20%

- Operating temperature range - 40°C ~ 105°C(Including self - temperature rise)
- IDC for Inductance drop 10% from its value without current.
- Measure Equipment :
 Z : Agilent HP4291A
 RDC : HP4338B or Chroma 16502 (Single Wire Test Value)
 IDC : HP4284A+HP42841A/HP4285A+HP42841A
 Insulation Resistance : Agilent HP4339B

SMD Common Mode Choke

BWCU_02 Series For USB 2.0, IE EE1394b, LVDS Applications

Test Instruments : HP4291A Material/Impedance Analyzer

Typical Impedance vs. Frequency

BWCU00231512900M02

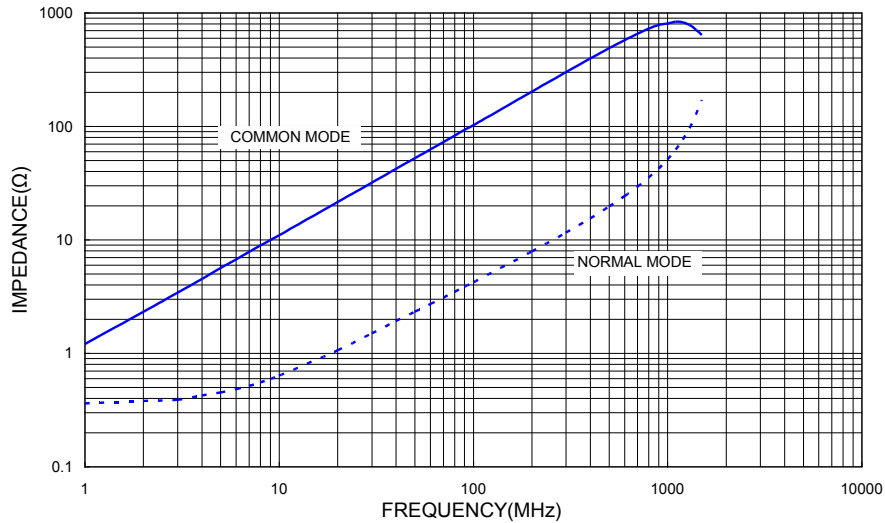

Packaging Specifications

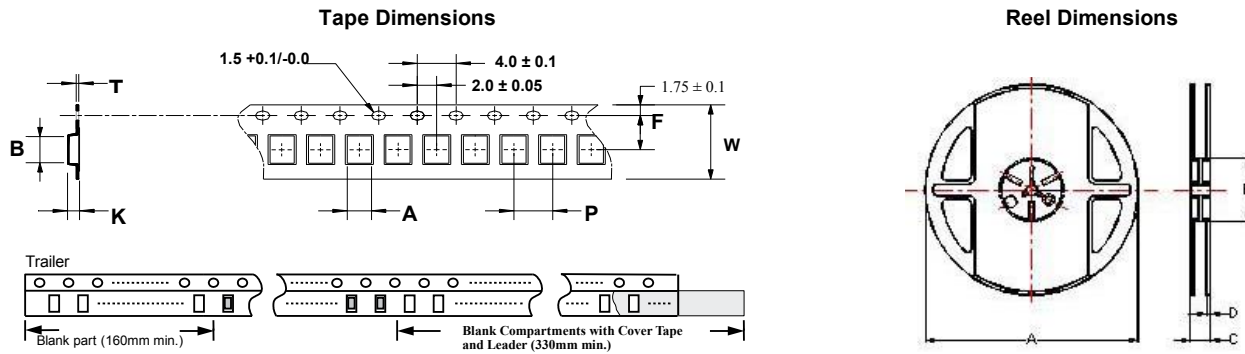

Dimensions in mm

TYPE	Tape Dimensions							Reel Dimensions				Quantity PCS / Reel
	A	B	T	W	P	F	K	A	B	C	D	
BWCU00160811	0.95	1.70	0.24	8	4	3.5	1.15	178	60	12	1.5	2000
BWCU00121008	1.15	1.45	0.24	8	4	3.5	1.00	178	60	12	1.5	2000
BWCU00201212	1.50	2.25	0.24	8	4	3.5	1.35	178	60	12	1.5	2000
BWCU00231512	1.60	2.42	0.26	8	4	3.5	1.14	178	60	12	1.5	2000
BWCU00321619	1.76	3.47	0.22	8	4	3.5	2.05	178	60	12	1.5	2000

SMD Common Mode Choke

BWCU_02 Series For USB 2.0, IE EE1394b, LVDS Applications

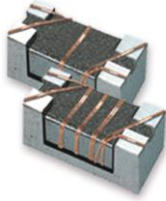

A full series of common mode choke is designed for excellent noise attenuation and compact sizing for use in wide range of applications. Both standard series and custom designs are available.

Features

- RoHS Compliant
- Miniature SMD type common mode filter for fully automated assembly
- Excellent solderability

Applications

- HDMI
- USB lines (for personal computers and peripheral), DVC, STB, LVDS, panel line for liquid display panels, etc.

Product Identification

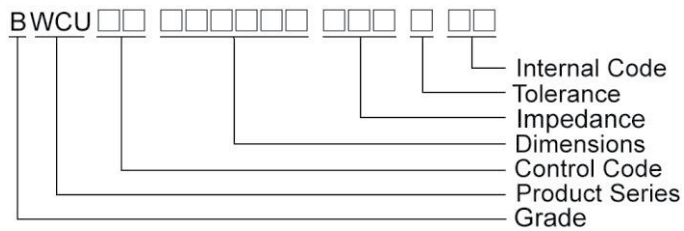

Shape and Dimensions

BWCU00121008

BWCU00201212

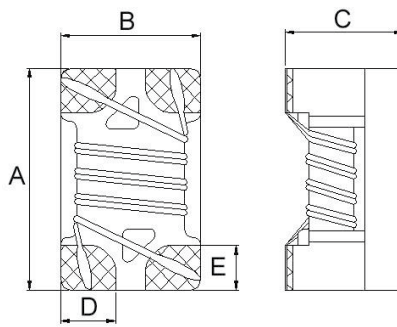
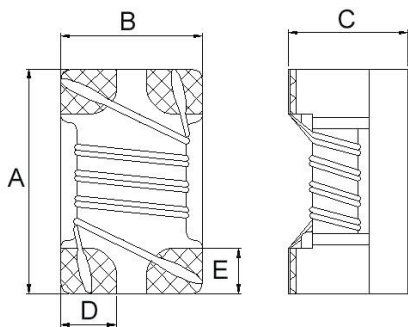

Recommended Pattern

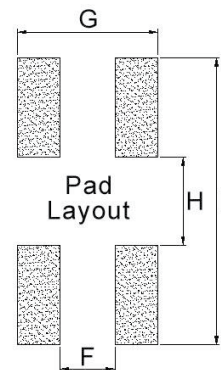

Dimensions in mm

TYPE	A	B	C	D	E	F	G	H	I
BWCU00121008	1.25±0.2	1.00±0.2	0.80±0.1	0.32	0.33	0.36	1.00	0.59	1.75
BWCU00201212	2.05±0.2	1.25±0.2	1.20±0.2	0.50	0.40	0.50	1.27	0.80	2.60

SMD Common Mode Choke

BWCU_02 Series For USB 2.0, IE EE1394b, LVDS Applications



Electrical Characteristics

Part Number	Impedance (Ω)	Tolerance (±%)	Test Frequency (MHz)	RDC (Ω) Max	IDC (mA) Max	Rated Voltage (Vdc)	Withstand Voltage (Vdc)	Insulation Resistance (MΩ) Min
BWCU00121008220Y03	22	25	100	0.20	400	50	125	100
BWCU00121008600Y03	60	25	100	0.40	250	50	125	100
BWCU00121008900Y03	90	25	100	0.30	250	50	125	100

Note: When ordering, please specify tolerance code. Tolerance: Y=±25%

- Operating temperature range - 40°C ~ 105°C(Including self - temperature rise)
- IDC for Inductance drop 10% from its value without current.
- Measure Equipment :
 Z : HP4286A/HP4287A/Agilent E4991A+Agilent16197A
 RDC : Chroma 16502 (Single Wire Test Value)
 IDC : HP4284A+HP42841A/HP4285A+HP42841A
 Insulation Resistance : Agilent HP4339B

Test Instruments : HP4291A Material/Impedance Analyzer

Typical Impedance vs. Frequency

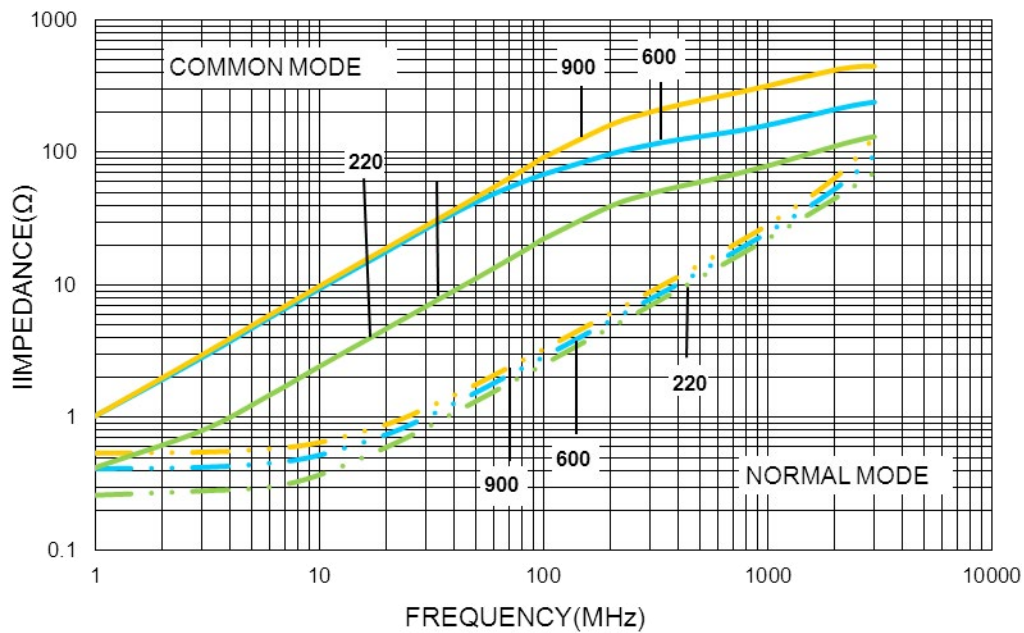

SMD Common Mode Choke

BWCU_02 Series For USB 2.0, IE EE1394b, LVDS Applications



BWCU00121008220Y03

Insertion Loss For HDMI2.0 Testing:

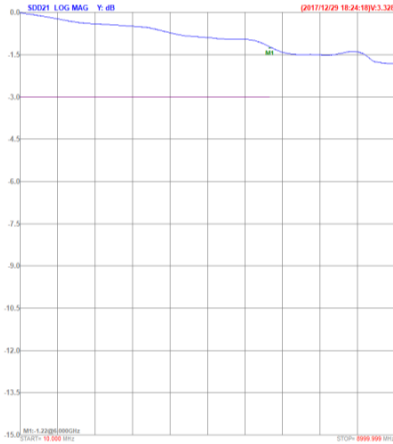

Insertion Loss For USB3.0 Testing:

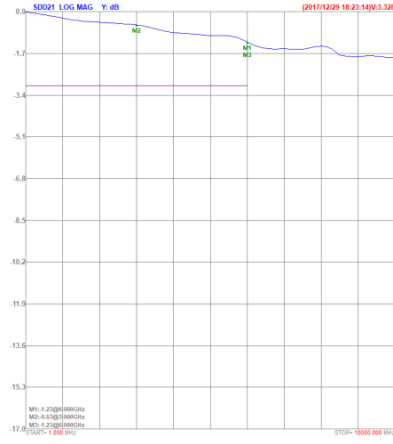

TDR For HDMI2.0 Testing:

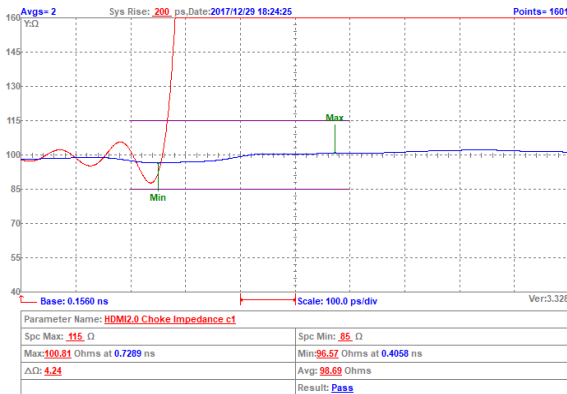

TDR For USB3.0 Testing:

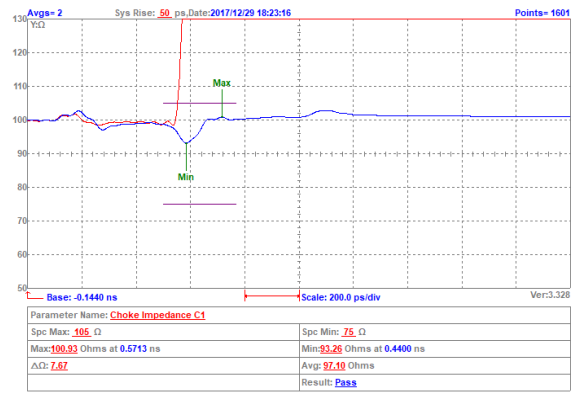

Eye Diagram For HDMI2.0 Testing:

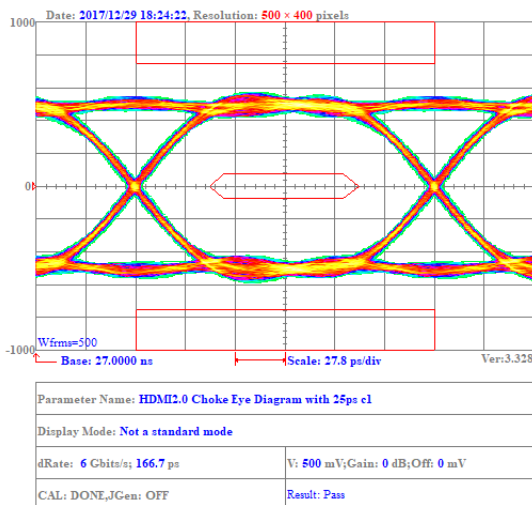

Eye Diagram For USB3.0 Testing:

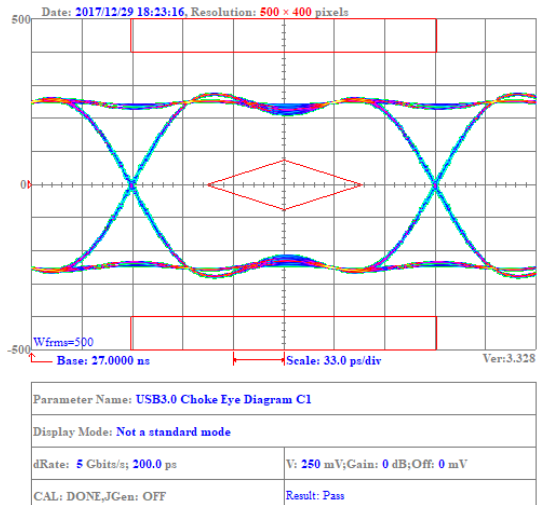

SMD Common Mode Choke

BWCU_02 Series For USB 2.0, IE EE1394b, LVDS Applications



BWCU00121008600Y03

Insertion Loss For HDMI2.0 Testing:

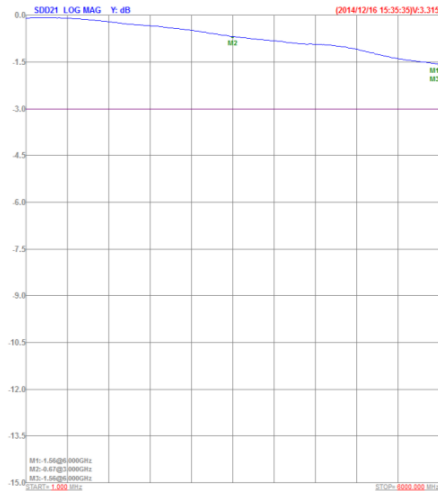

Insertion Loss For USB3.0 Testing:

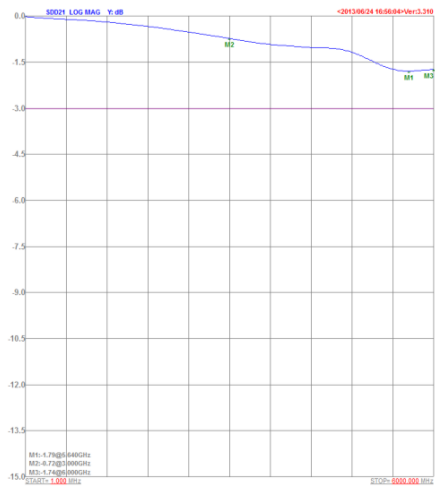

TDR For HDMI2.0 Testing:

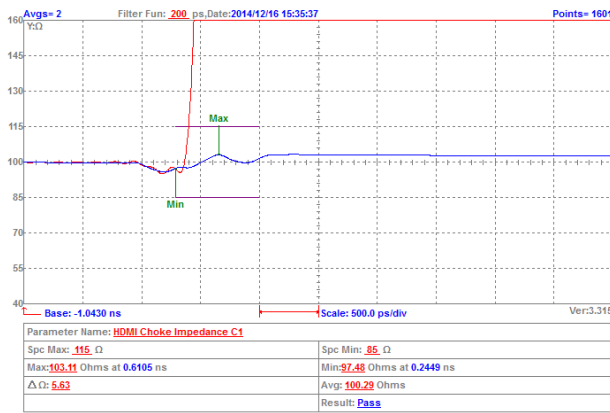

TDR For USB3.0 Testing:

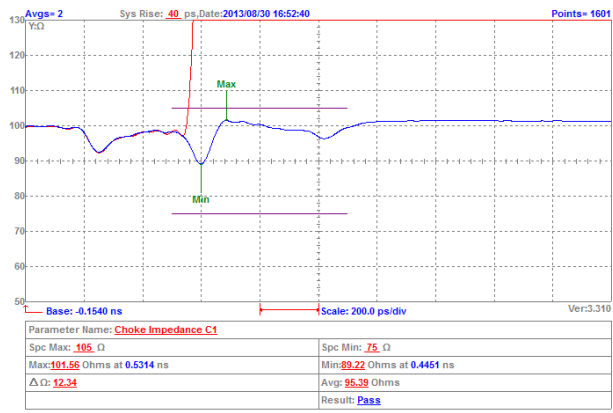

Eye Diagram For HDMI2.0 Testing:

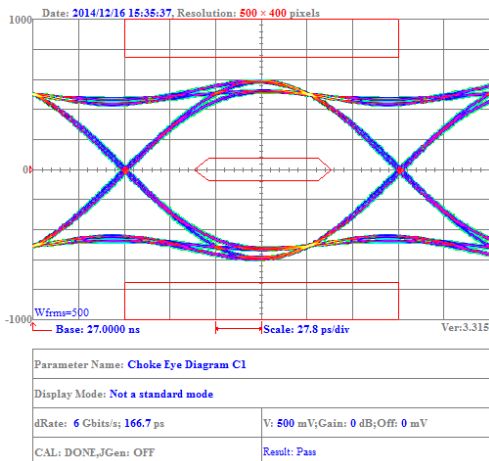

Eye Diagram For USB3.0 Testing:

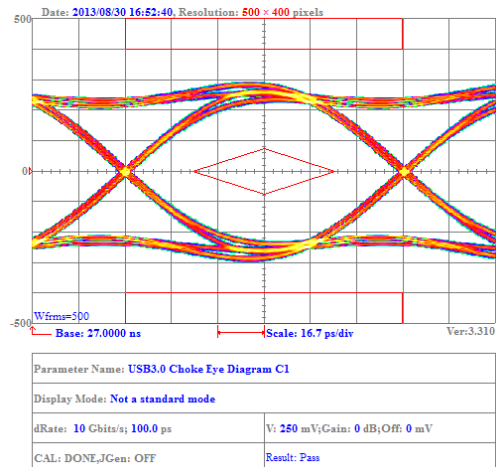

SMD Common Mode Choke

BWCU_02 Series For USB 2.0, IE EE1394b, LVDS Applications



BWCU00121008900Y03

Insertion Loss For HDMI2.0 Testing:

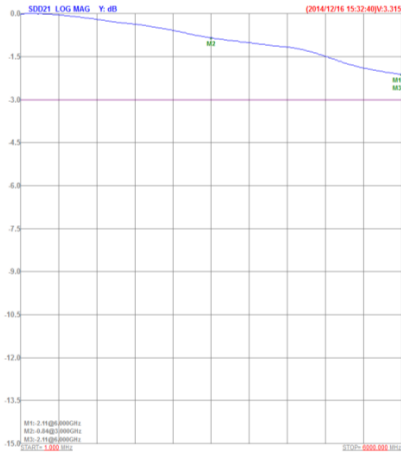

Insertion Loss For USB3.0 Testing:

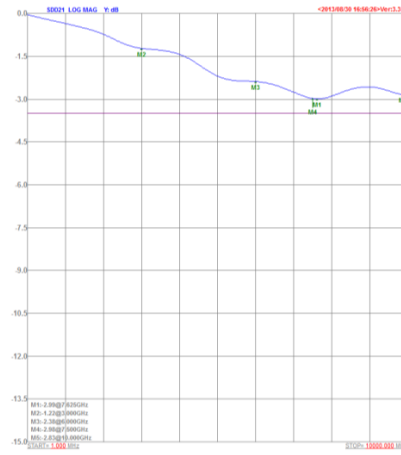

TDR For HDMI2.0 Testing:

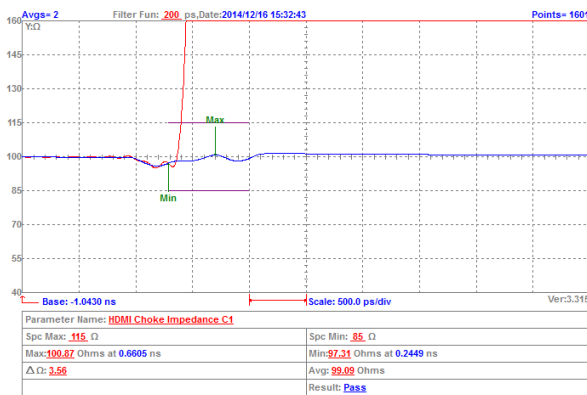

TDR For USB3.0 Testing:

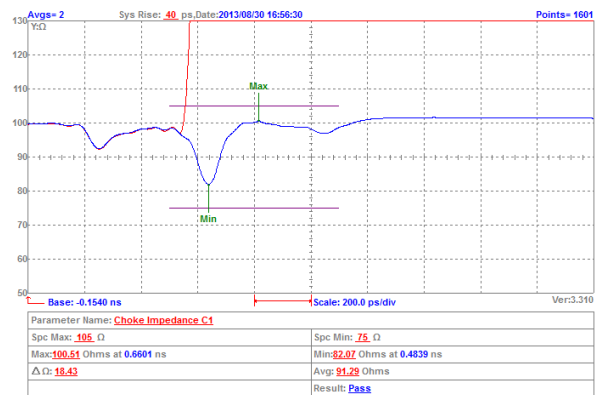

Eye Diagram For HDMI2.0 Testing:

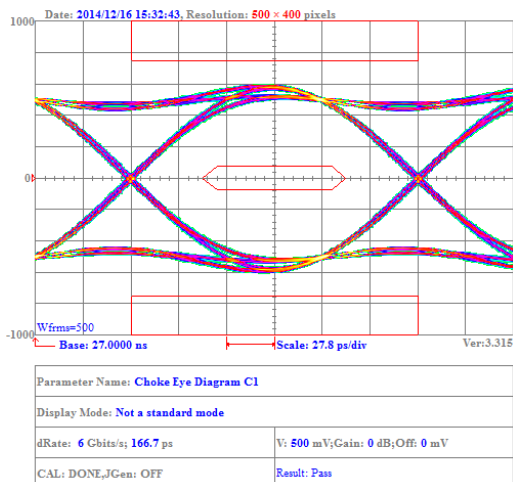

Eye Diagram For USB3.0 Testing:

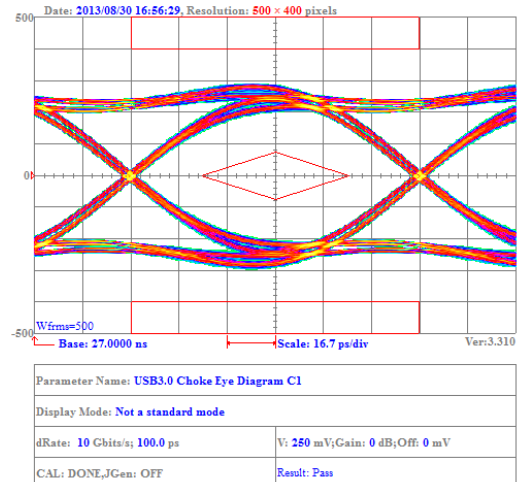

SMD Common Mode Choke

BWCU_02 Series For USB 2.0, IE EE1394b, LVDS Applications



Electrical Characteristics

Part Number	Impedance (Ω)	Tolerance (±%)	Test Frequency (MHz)	RDC (Ω) Max	IDC (mA) Max	Rated Voltage (Vdc)	Withstand Voltage (Vdc)	Insulation Resistance (MΩ) Min
BWCU00201212500Y03	50	25	100	0.20	500	50	125	10
BWCU00201212670Y03	67	25	100	0.30	500	50	125	10
BWCU00201212900Y03	90	25	100	0.30	500	50	125	10
BWCU00201212121Y03	120	25	100	0.35	330	50	125	10
BWCU00201212131Y03	130	25	100	0.40	300	50	125	10

Note: When ordering, please specify tolerance code. Tolerance: Y=±25%

- Operating temperature range - 40°C ~ 105°C(Including self - temperature rise)
- IDC for Inductance drop 10% from its value without current.
- Measure Equipment :
 Z : HP4286A/HP4287A/Agilent E4991A+Agilent16197A
 RDC : Chroma 16502 (Single Wire Test Value)
 IDC : HP4284A+HP42841A/HP4285A+HP42841A
 Insulation Resistance : Agilent HP4339B

Test Instruments : HP4291A Material/Impedance Analyzer

Typical Impedance vs. Frequency

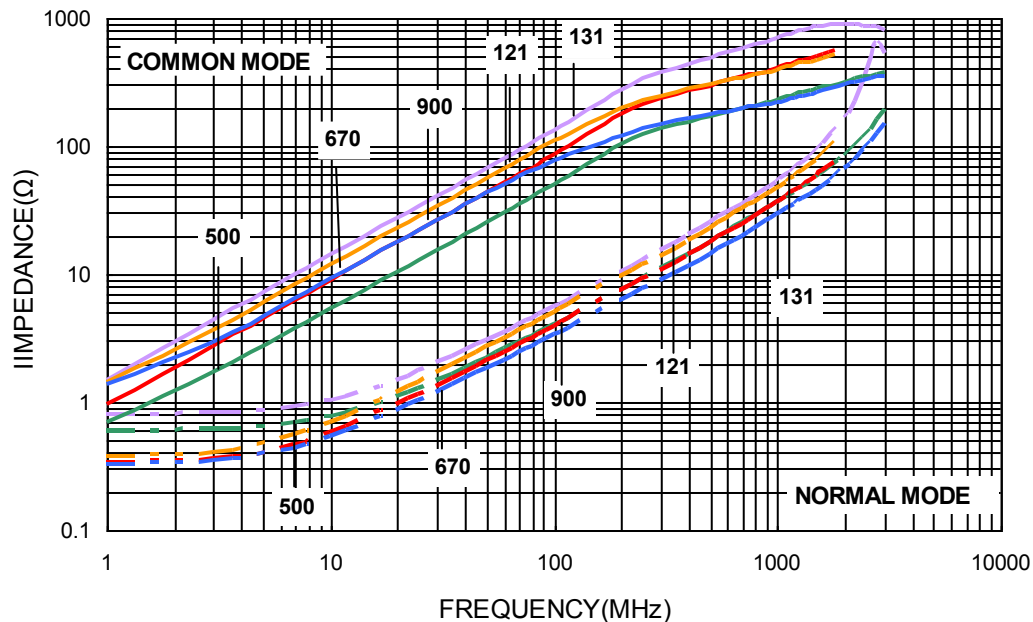

SMD Common Mode Choke

BWCU_02 Series For USB 2.0, IE EE1394b, LVDS Applications



BWCU00201212500Y03

Insertion Loss For HDMI2.0 Testing:

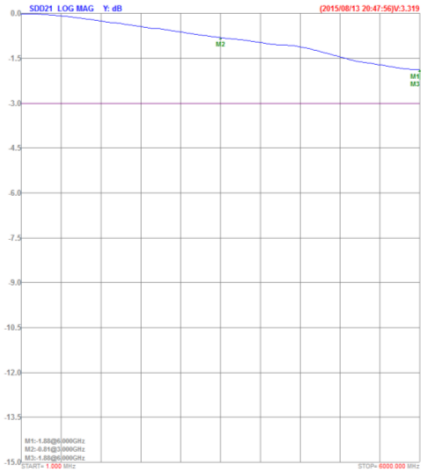

Insertion Loss For USB3.0 Testing:

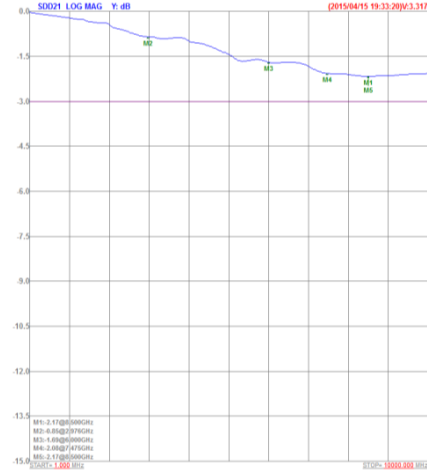

TDR For HDMI2.0 Testing:

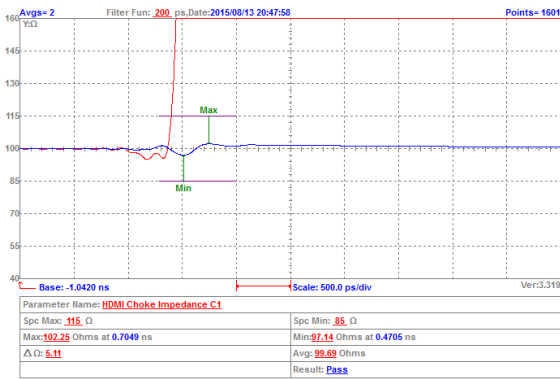

TDR For USB3.0 Testing:

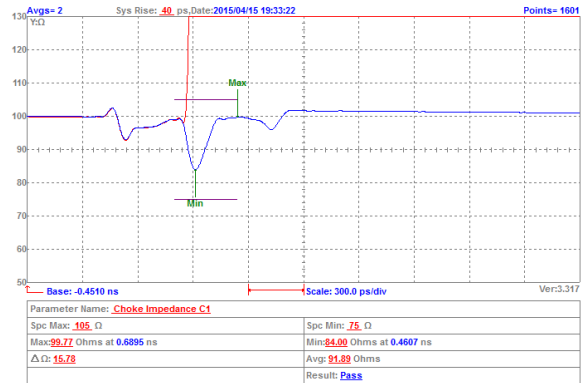

Eye Diagram For HDMI2.0 Testing:

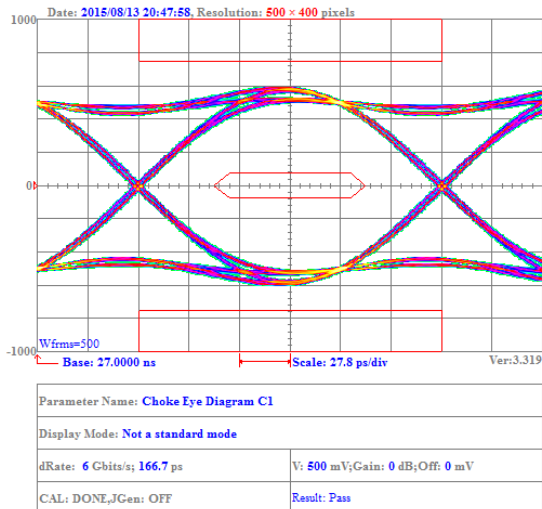

Eye Diagram For USB3.0 Testing:

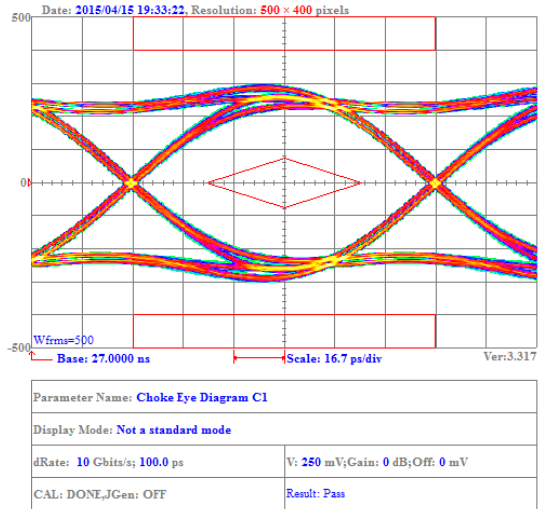

SMD Common Mode Choke

BWCU_02 Series For USB 2.0, IE EE1394b, LVDS Applications



BWCU00201212670Y03

Insertion Loss For HDMI2.0 Testing:

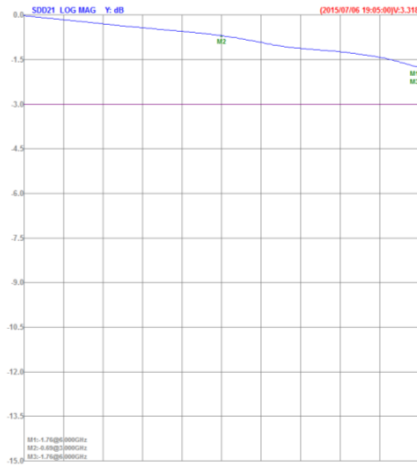

Insertion Loss For USB3.0 Testing:

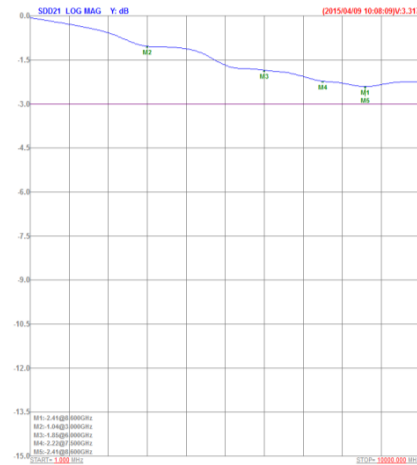

TDR For HDMI2.0 Testing:

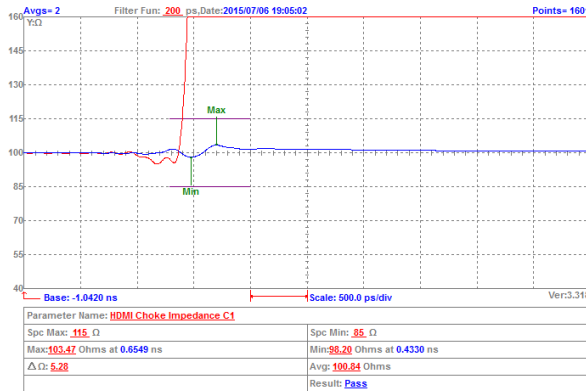

TDR For USB3.0 Testing:

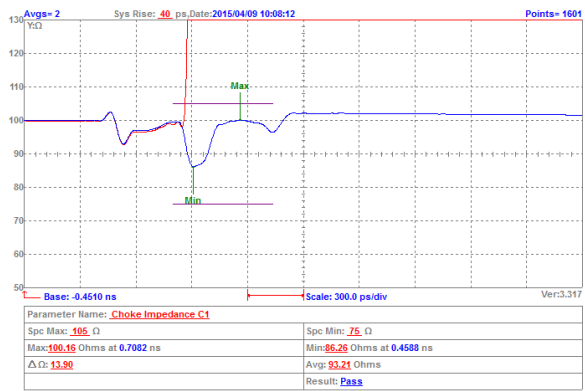

Eye Diagram For HDMI2.0 Testing:

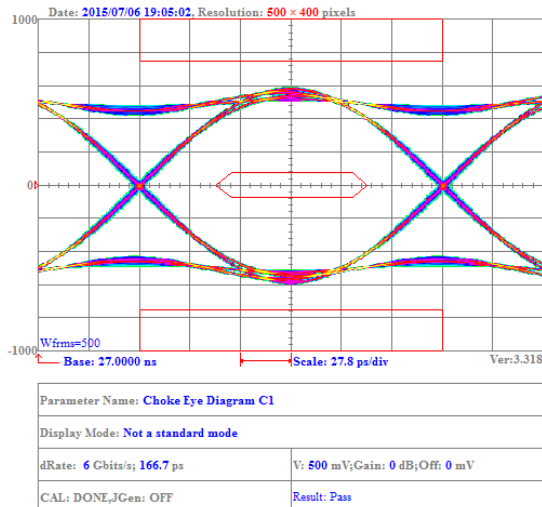

Eye Diagram For USB3.0 Testing:

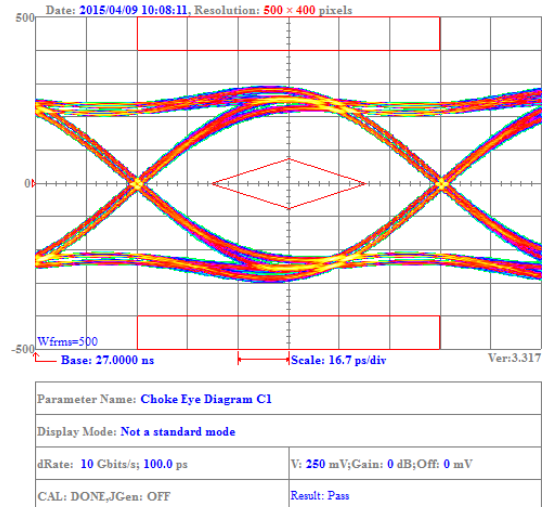

SMD Common Mode Choke

BWCU_02 Series For USB 2.0, IE EE1394b, LVDS Applications

BWCU00201212900Y03



Insertion Loss For HDMI2.0 Testing:

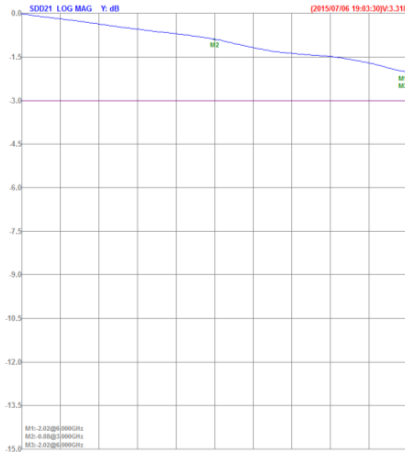

Insertion Loss For USB3.0 Testing:

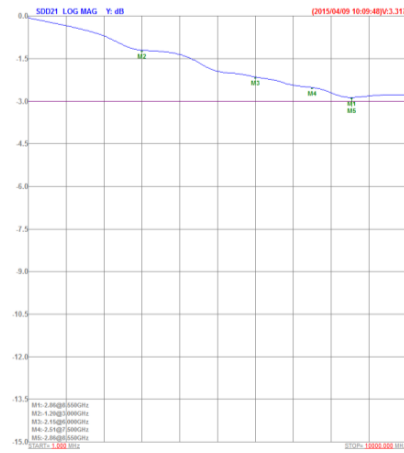

TDR For HDMI2.0 Testing:

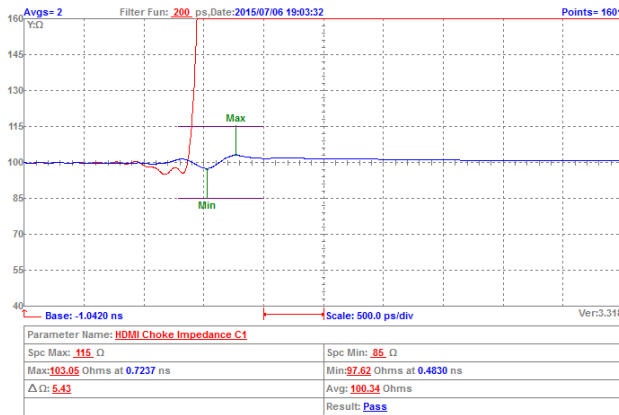

TDR For USB3.0 Testing:

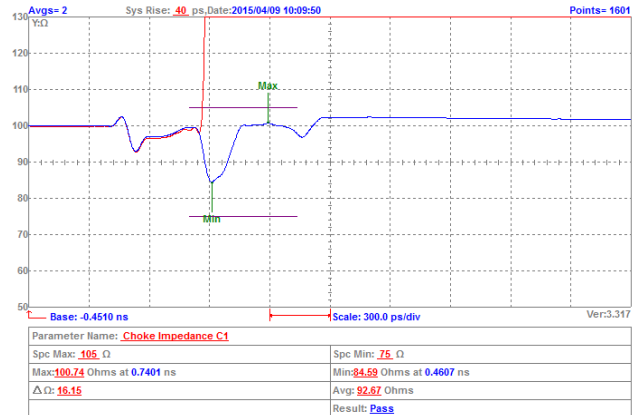

Eye Diagram For HDMI2.0 Testing:

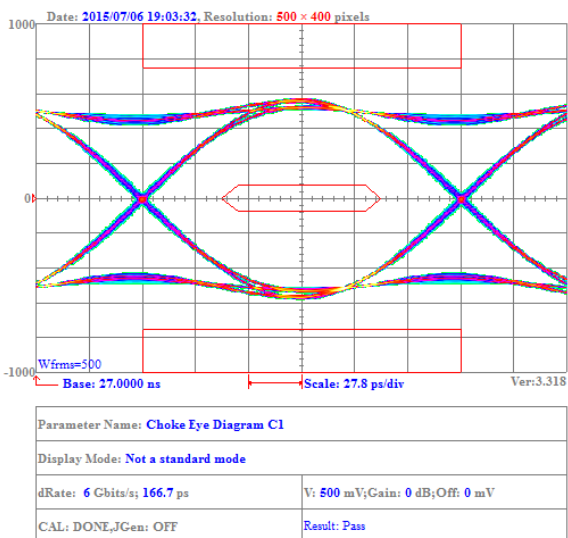

Eye Diagram For USB3.0 Testing:

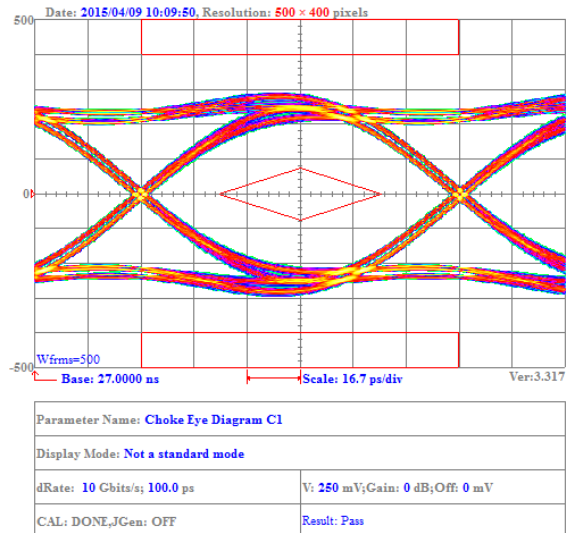

SMD Common Mode Choke

BWCU_02 Series For USB 2.0, IE EE1394b, LVDS Applications



BWCU00201212121Y03

Insertion Loss For HDMI2.0 Testing:

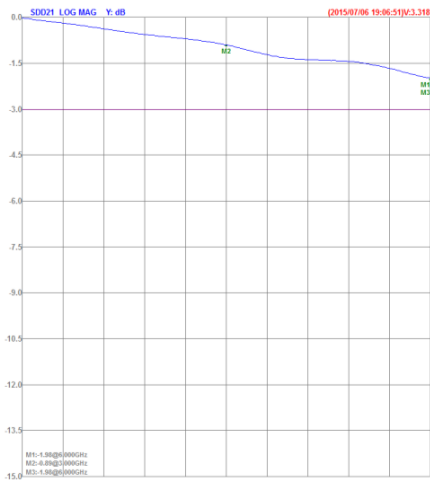

Insertion Loss For USB3.0 Testing:

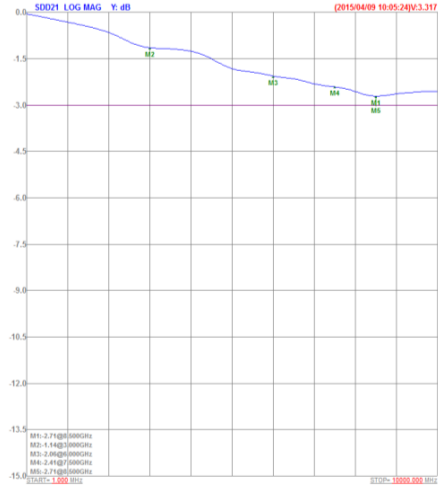

TDR For HDMI2.0 Testing:

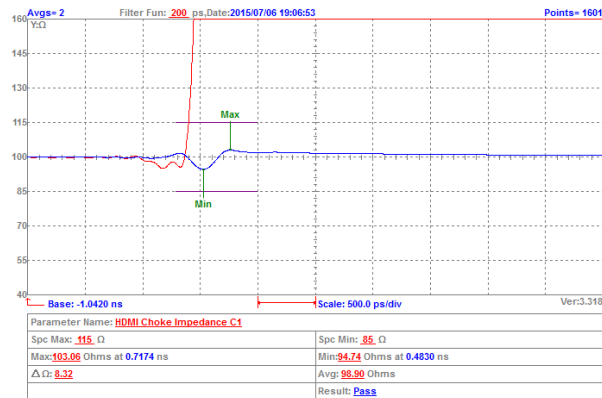

TDR For USB3.0 Testing:

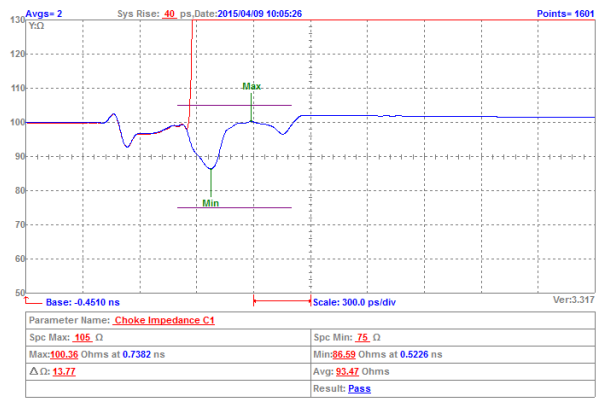

Eye Diagram For HDMI2.0 Testing:

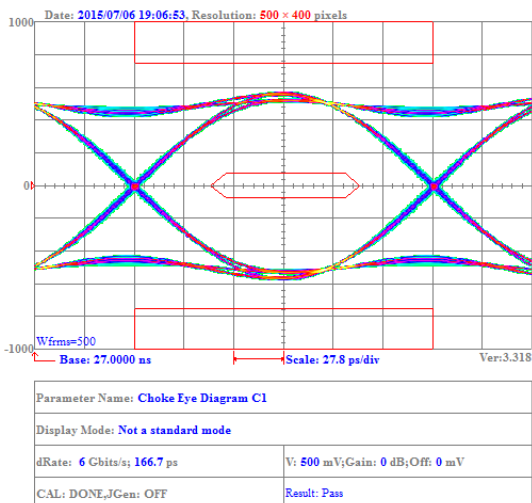

Eye Diagram For USB3.0 Testing:

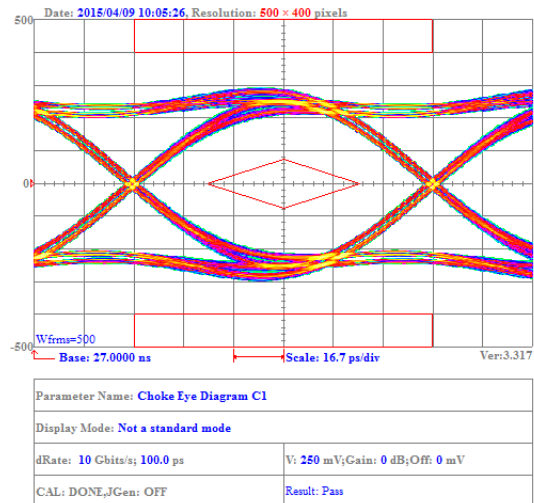

SMD Common Mode Choke

BWCU_02 Series For USB 2.0, IE EE1394b, LVDS Applications

BWCU00201212131Y03



Insertion Loss For HDMI Testing:

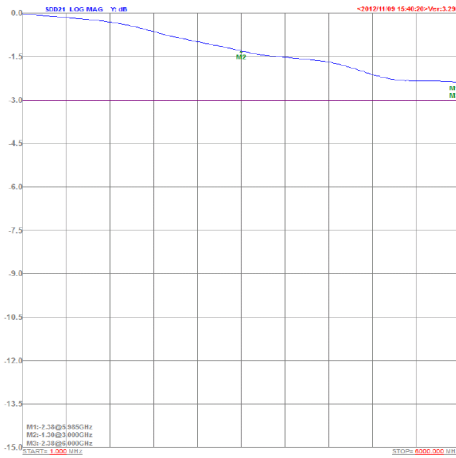

Insertion Loss For USB3.0 Testing:

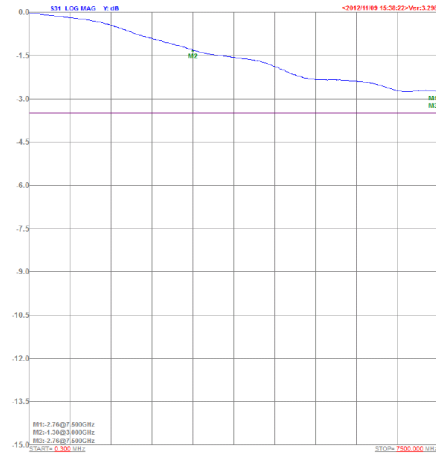

TDR For HDMI Testing:

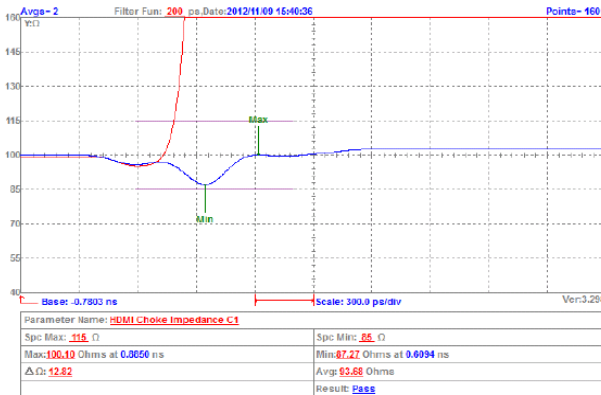

TDR For USB3.0 Testing:

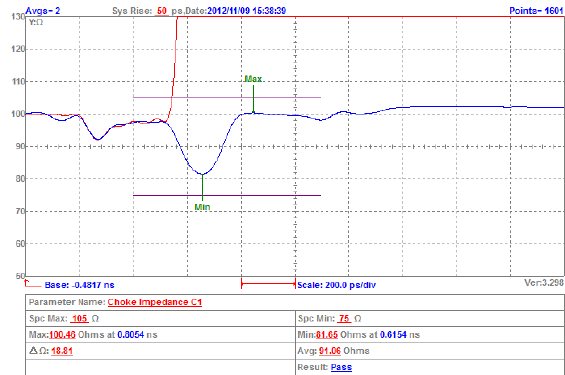

Eye Diagram For HDMI Testing:

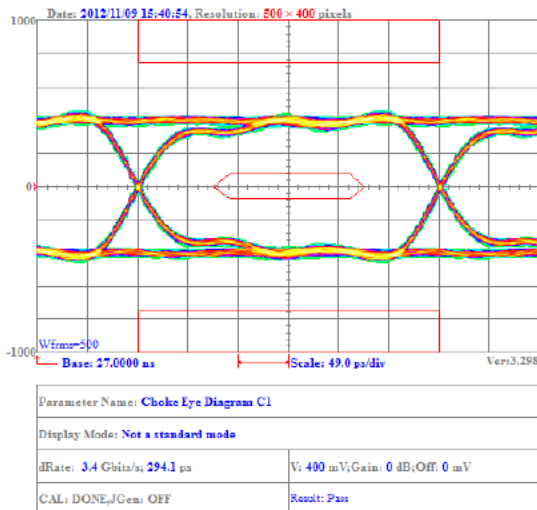

Eye Diagram For USB3.0 Testing:

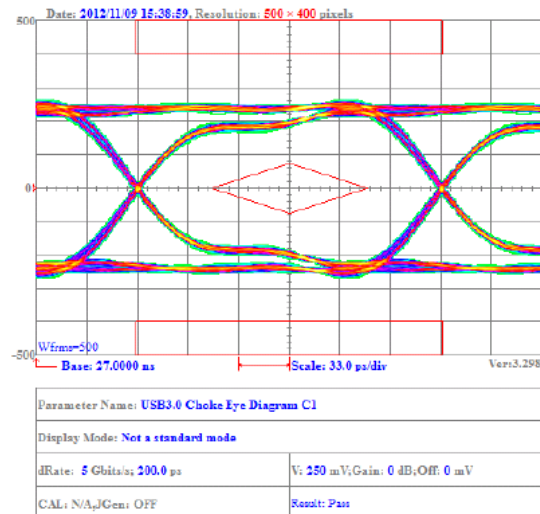

SMD Common Mode Choke

BWCU_02 Series For USB 2.0, IE EE1394b, LVDS Applications

Packaging Specifications

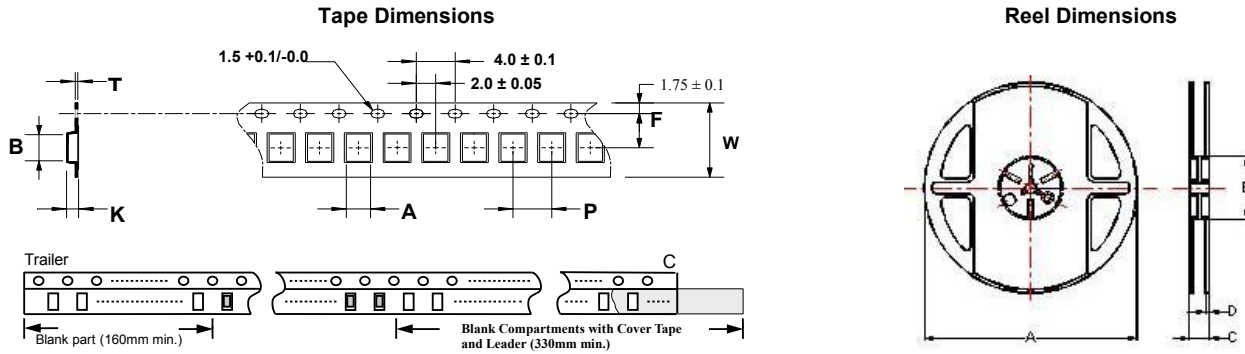

Dimensions in mm

TYPE	Tape Dimensions							Reel Dimensions				Quantity PCS / Reel
	A	B	T	W	P	F	K	A	B	C	D	
BWCU00121008	1.15	1.45	0.25	8	4	3.5	1.00	178	60	12	1.5	2000
BWCU00201212	1.50	2.25	0.24	8	4	3.5	1.35	178	60	12	1.5	2000

For More Information:

Americas - prodinfo_power_americas@yageo.com | Europe - prodinfo_power_emea@yageo.com | Asia - prodinfo_power_asia@yageo.com

Performance warranty of products offered on this data sheet is limited to the parameters specified. Data is subject to change without notice. Other brand and product names mentioned herein may be trademarks or registered trademarks of their respective owners. © Copyright, 2022. Pulse Electronics, Inc. All rights reserved.