

	0.10	MAX
	0.12	MAX

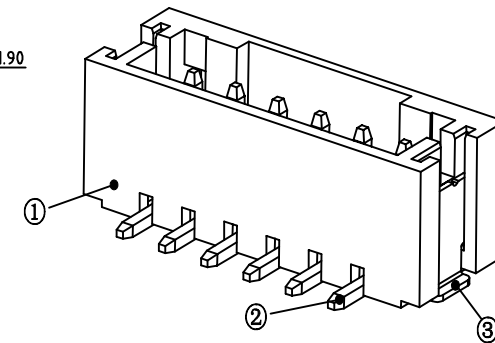
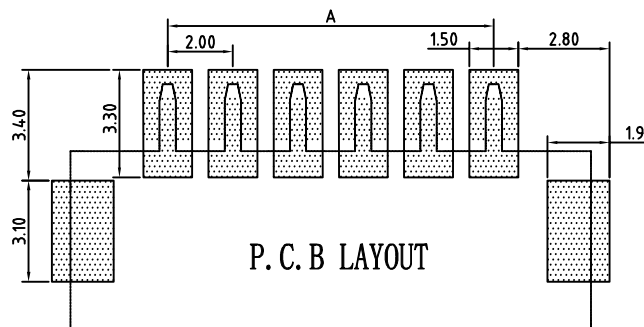
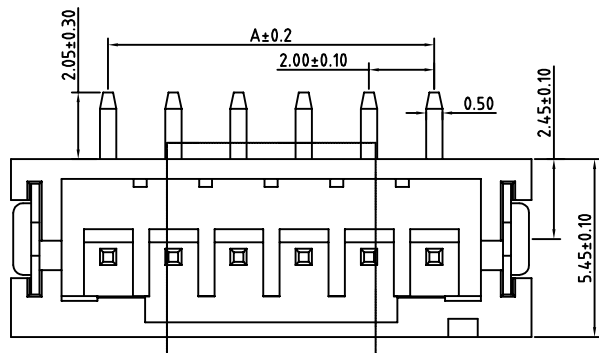
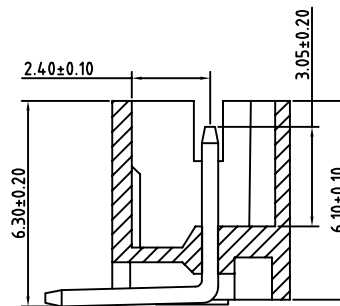
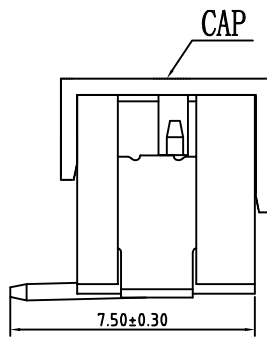

Pin	A	B
2	2.00	8.00
3	4.00	10.00
4	6.00	12.00
5	8.00	14.00
6	10.00	16.00
7	12.00	18.00
8	14.00	20.00
9	16.00	22.00
10	18.00	24.00
11	20.00	26.00
12	22.00	28.00
13	24.00	30.00
14	26.00	32.00
15	28.00	34.00
16	30.00	36.00

技术参数

间距: 2.0  
 温度范围: -25~+85°C  
 额定电压: 250V AC, DC  
 额定电流: 2.0A AC, DC  
 接触电阻: 20mΩ  
 绝缘电阻: 800MΩ  
 耐压: 500V AC/minute

线性公差 / General Tolerance	
X	±0.2
X.X	±0.1
X.XX	±0.05
角度公差 / Angle Tolerance	
X°	±5.0°
X.X°	±3.0°
X.XX°	±1.0°

视角 / Projection

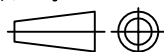

A1	调整平面		
标记	更改内容	签名	年月日
绘图			
审核			
工艺		批准	

材料 / Material

- ①塑座: LCP 本色
- ②接触针: 黄铜(镀锡)
- ③焊片: 黄铜(镀锡)

单位 (Units)    版本    比例

mm    2.0    1:1

共 1 张    第 1 张

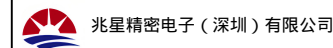

品名 / ProduceName

PH2.0 立贴 9P

型号 / Model

ZX-PH2.0-LT9P