

 CENTER CONTACT
 GROUND CONTACT

RECOMMENDED PCB LAYOUT
(TOLERANCE: ±0.05)

NOTES

- 1.0. RATING (额定值) :
- 1.1. VOLTAGE (电压) : 60 VAC (R.M.S.)
 - 1.2. NOMINAL CHARACTERISTIC IMPEDANCE (特性阻抗) : 50 Ohm
 - 1.3. APPLICABLE FREQUENCY (适用频率) : DC ~ 6GHz
 - 1.4. VSWR (电压驻波比) : 1.3 MAX. (DC~3GHz), 1.5 MAX. (3~6GHz)
 - 1.5. TEMPERATURE (适用温度) : -40°C TO +85°C
 - 1.6. APPLIED TO IR SOLDERING PROCESS (适用回流焊接方式)
- 2.0. MATERIAL SEE BILL OF MATERIAL (材料清单) :
- 2.1. HOUSING (塑胶) : THERMOPLASTIC LCP, UL94V-0 (LCP符合UL94V-0)
 - 2.2. CENTER CONTACT : COPPER ALLOY C5191
 - 2.3. SHELL CONTACT (外壳) : COPPER ALLOY C5191 (铜合金C5191)

MANUFACTURE DWG		 东莞市讯普电子科技有限公司 DongGuan XunPu Electronics Co., Ltd	
UNLESS OTHERWISE SPECIFIED TOLERANCES			TITLE: MICRO RF I BOARD SMT 4 PADS TYPE
DECIMALS:	ANGLES:		PAR IPEX-002
X.X±0.15	.*±2.0°		DWN
X.XX±0.05	X.*±2.0°		CHKD
X.XXX±0.05	X.X*±1.0°	APVD	SCALE: 1:1 UNIT: MM
CUSTOMER COPY		SIZE: A4	SHEET: 1F1 REV: A

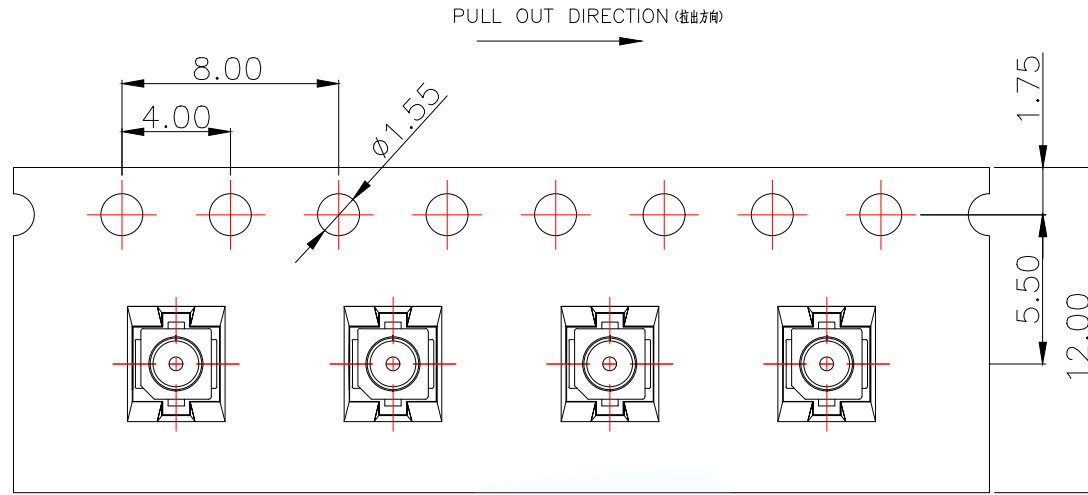

NOTES(备注):

- MATERIAL(材料):
 - EMBOSSED CARRIER(载带): PET
 - COVER TAPE(盖带): PET
 - REEL(卷盘): PS
 - SHIPPING CARTON(包装箱): CORRUGATED FIBER(多层瓦楞纸)
- DIMENSION(尺寸):
 - REEL(卷盘): W=12.5
 - SHIPPING CARTON(包装箱): L=350, W=350, H=190
- QUANTITY(数量):
 - PRIMARY PACKING(基本包装): 5000PCS/REEL
 - CRITERION PACKING(标准包装): 10REELS/CARTON(10卷/箱50000PCS)
- WEIGHT(重量):
 - NET WEIGHT(净重): 0.50KG/REEL.
 - GROSS WEIGHT(总重): 0.50KG/REEL, 5.5KG/CARTON.
- PEELING RESISTANCE(盖带剥离力): 10gf~130gf.

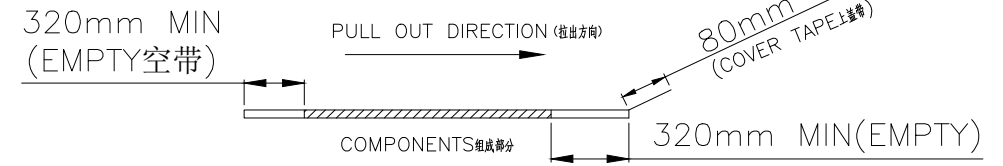
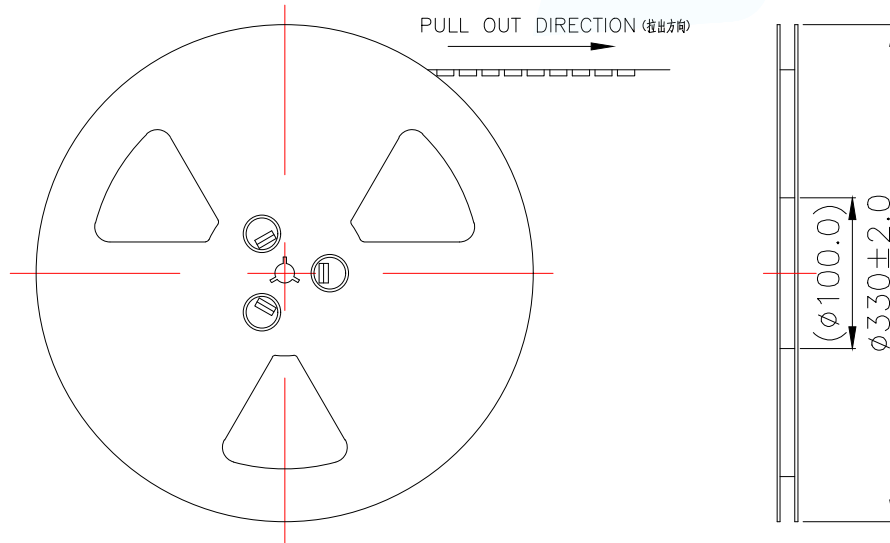

MANUFACTURE DWG		 东莞市讯普电子科技有限公司 DongGuan XunPu Electronics Co.,Ltd	
UNLESS OTHERWISE SPECIFIED TOLERANCES			TITLE: MICRO RF 1 BOARD SMT 4 PADS TYPE
DECIMALS:	ANGLES:		PAR IPEX-002
X.X±0.15	.°±2.0°		DWN
X.XX±0.05	X.*±2.0°		CHKD
X.XXX±0.05	X.X*±1.0°	APVD	SCALE:1:1 UNIT:MM
CUSTOMER COPY		SIZE:A4	SHEET:1F1 REV:A

△ ID LABEL

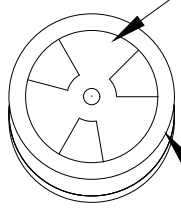

5,000PCS/REEL

10REELS/CARTON

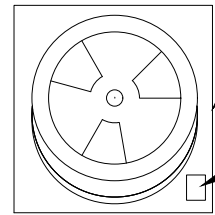
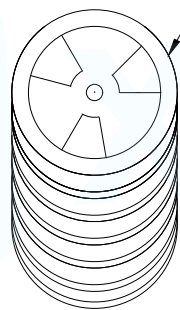

PE BAG

DRY BAG

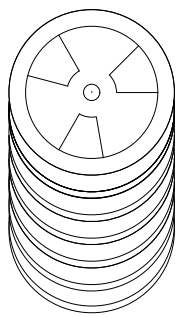



品名 NAME:	_____
料号 PART No.:	_____
客户料号 CLIENT P/N:	_____
客户订单 CLIENT PO#:	_____
数量 Q'TY:	_____
重量 WEIGHT:	_____
批次 LOT No.:	_____
日期 DATE:	_____

ID LABEL

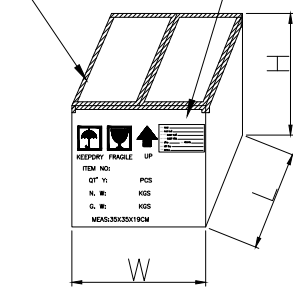
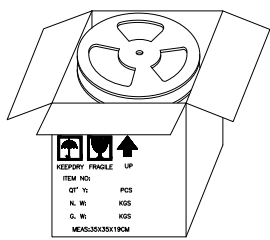
ID LABEL
STICK TAPE



MANUFACTURE DWG		 东莞市讯普电子科技有限公司 DongGuan XunPu Electronics Co.,Ltd		
UNLESS OTHERWISE SPECIFIED TOLERANCES			TITLE: MICRO RF I BAORD SMT 4 PADS TYPE	
DECIMALS:	ANGLES:		PAR IPEX-002	
X.X±0.15	.°±2.0°		DWN	
X.XX±0.05	X.°±2.0°		CHKD	
X.XXX±0.05	X.X°±1.0°	APVD		
CUSTOMER COPY		SCALE 1:1	UNIT:MM	
		SIZE:A4	SHEET:1F1	
			REV:A	