

RECOMMENDED PCB LAYOUT  
(TOLERANCE: ±0.05)

 CENTER CONTACT  
 GROUND CONTACT

NOTES

- 1.0. RATING (额定值) :
- 1.1. VOITAGE (电压) : 60 VAC (R.M.S.)
  - 1.2. NOMINAL CHARACTERISTIC IMPEDANCE (特性阻抗) : 50 Ohm
  - 1.3. APPLICABLE FREQUENCY (适用频率) : DC ~ 6GHz
  - 1.4. VSWR (电压驻波比) : 1.3 MAX. (DC~3GHz), 1.5 MAX. (3~6GHz)
  - 1.5. TEMPERATURE (适用温度) : -40°C TO +85°C
  - 1.6. APPLIED TO IR SOLDERING PROCESS (适用回流焊方式)
- 2.0. MATERIAL SEE BILL OF MATERIAL (材料清单) :
- 2.1. HOUSING (塑壳) : THERMOPLASTIC LCP, UL94V-0 (LCP符合UL94V-0),
  - 2.2. CENTER CONTACT: COPPER ALLOY C5191
  - 2.3. SHELL CONTACT (外壳) : COPPER ALLOY C5191 (铜合金C5191).

MANUFACTURE DWG		 东莞市讯普电子科技有限公司 DongGuan XunPu Electronics Co.,Ltd	
UNLESS OTHERWISE SPECIFIED TOLERANCES			TITLE: MICRO RF I BAORD SMT 3 PADS TYPE
DECIMALS:	ANGLES:		PAR IPEX-001
X.X±0.15	.°±2.0°		DWN
X.XX±0.05	X.°±2.0°		CHKD
X.XXX±0.05	X.X°±1.0°	APVD	SCALE:1:1 UNIT:MM
CUSTOMER COPY		SIZE:A4	SHEET:1F1 REV:A

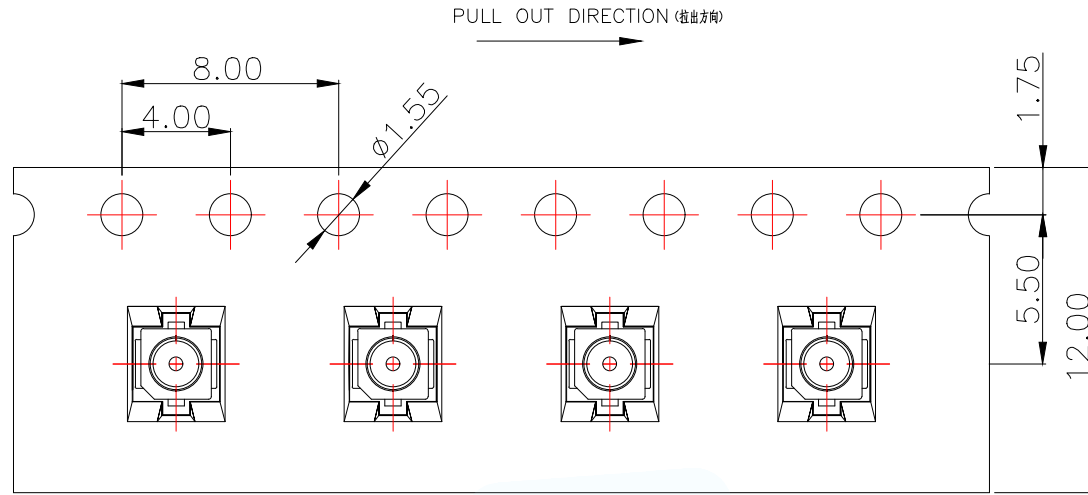

NOTES(备注):

- MATERIAL(材料):
  - EMBOSSED CARRIER(载带): PET
  - COVER TAPE(盖带): PET
  - REEL(卷盘): PS
  - SHIPPING CARTON(包装箱): CORRUGATED FIBER(多层瓦楞纸)
- DIMENSION(尺寸):
  - REEL(卷盘): W=12.5
  - SHIPPING CARTON(包装箱): L=350, W=350, H=190
- QUANTITY(数量):
  - PRIMARY PACKING(基本包装): 5000PCS/REEL
  - CRITERION PACKING(标准包装): 10REELS/CARTON(10卷/箱50000PCS)
- WEIGHT(重量):
  - NET WEIGHT(净重): 0.50KG/REEL.
  - GROSS WEIGHT(总重): 0.50KG/REEL, 5.5KG/CARTON.
- PEELING RESISTANCE(盖带剥离力): 10gf~130gf.

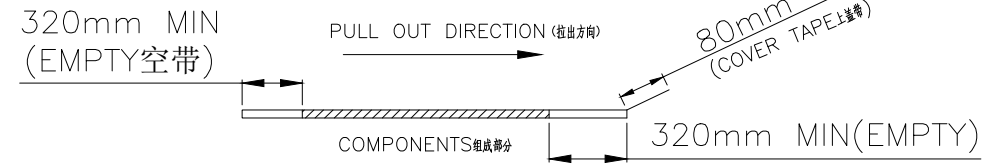
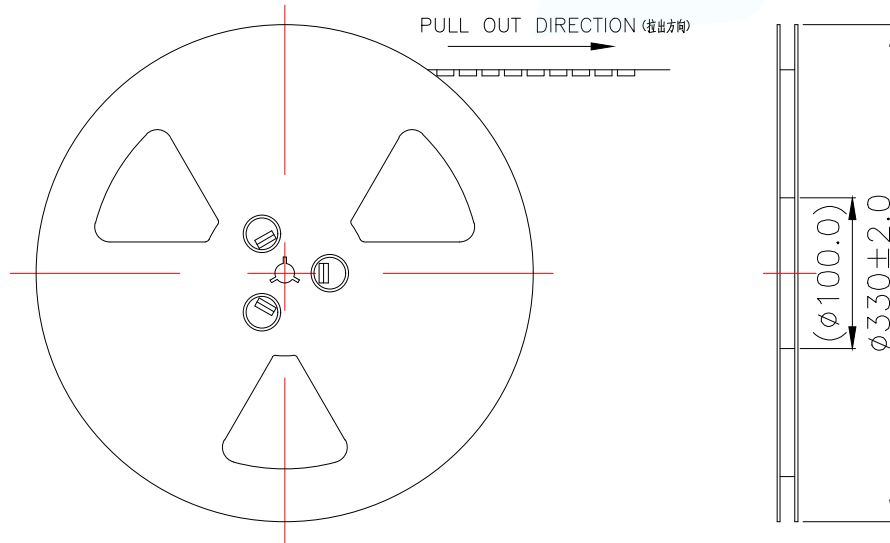

MANUFACTURE DWG		 东莞市讯普电子科技有限公司 DongGuan XunPu Electronics Co.,Ltd		
UNLESS OTHERWISE SPECIFIED TOLERANCES		 TITLE: MICRO RF I BAORD SMT 3 PADS TYPE	PAR	IPEX-001
DECIMALS:	ANGLES:		DWN	
X.X±0.15	.°±2.0°		CHKD	
X.XX±0.05	X.*±2.0°		APVD	
X.XXX±0.05	X.X*±1.0°	CUSTOMER COPY	SCALE:1:1	UNIT:MM
			SIZE:A4	SHEET:1F1
				REV:A

△ ID LABEL

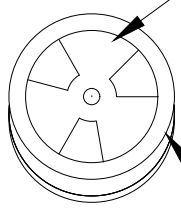

5,000PCS/REEL

10REELS/CARTON

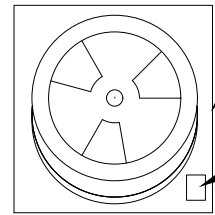
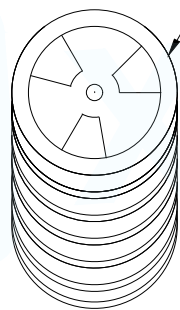

PE BAG

DRY BAG

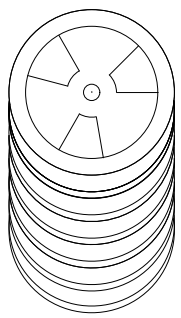



品名 NAME: \_\_\_\_\_  
 料号 PART No.: \_\_\_\_\_  
 客户料号 CLIENT P/N: \_\_\_\_\_  
 客户订单 CLIENT PO#: \_\_\_\_\_  
 数量 Q'TY: \_\_\_\_\_ 重量 WEIGHT: \_\_\_\_\_  
 批次 LOT No.: \_\_\_\_\_  
 日期 DATE: \_\_\_\_\_

ID LABEL

STICK TAPE

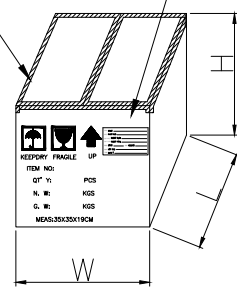
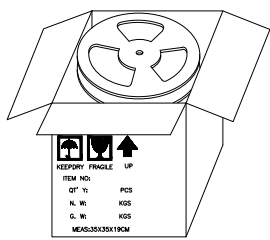
ID LABEL



MANUFACTURE DWG		 东莞市讯普电子科技有限公司 DongGuan XunPu Electronics Co.,Ltd	
UNLESS OTHERWISE SPECIFIED TOLERANCES			TITLE: MICRO RF I BAORD SMT 3 PADS TYPE
DECIMALS:	ANGLES:		PAR IPEX-001
X.X±0.15	.°±2.0°		DWN
X.XX±0.05	X.°±2.0°		CHKD
X.XXX±0.05	X.X°±1.0°	APVD	SCALE 1:1 UNIT:MM
CUSTOMER COPY		SIZE:A4	SHEET:1F1 REV:A