



General Features

N-Channel

$V_{DS} = 40V, I_D = 8A$

$R_{DS(ON)} < 19m\Omega @ V_{GS} = 10V$

$R_{DS(ON)} < 29m\Omega @ V_{GS} = 4.5V$

P-Channel

$V_{DS} = -40V, I_D = -7A$

$R_{DS(ON)} < 35m\Omega @ V_{GS} = -10V$

$R_{DS(ON)} < 45m\Omega @ V_{GS} = -4.5V$

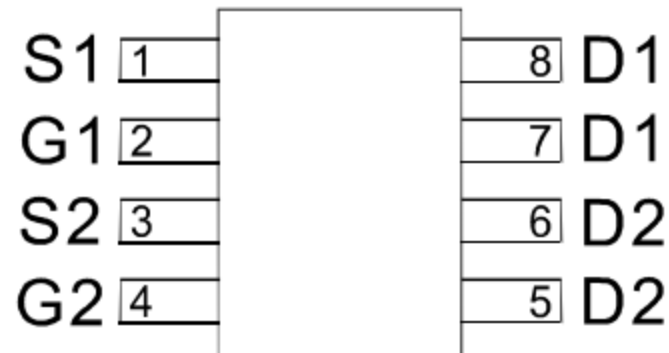
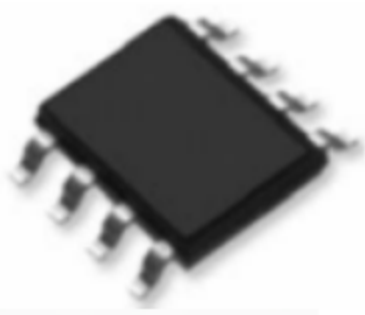
Application

- High power and current handling capability
- Lead free product is acquired
- Surface mount package

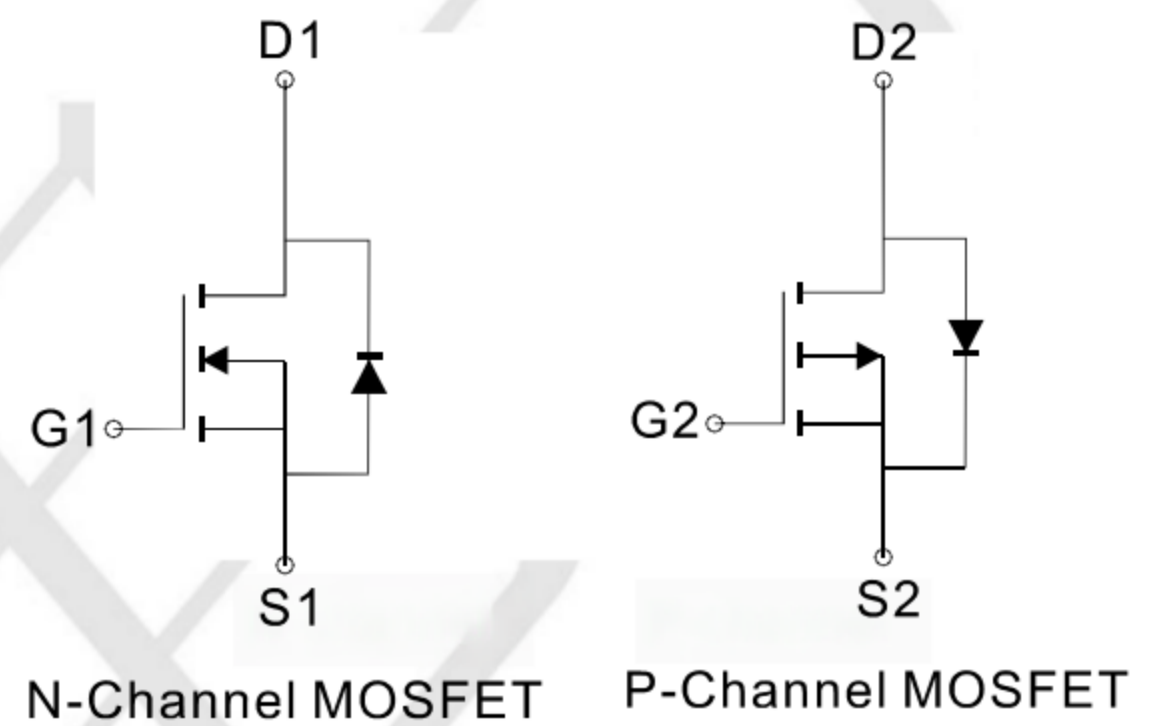
Package and Pin Configuration

(SOP-8)

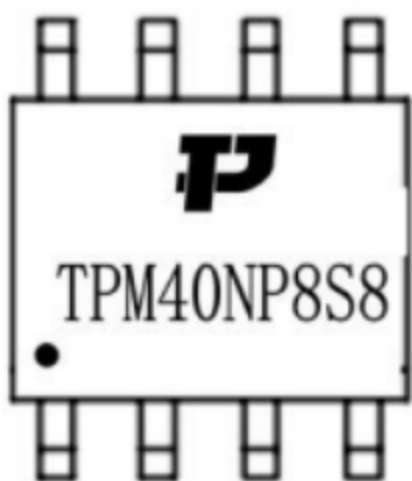
Top View



Circuit diagram



Marking



Absolute Maximum Ratings ( $T_A = 25^\circ C$  unless otherwise noted)

Parameter	Symbol	N-Channel	P-Channel	Unit
Drain-Source Voltage	$V_{DS}$	40	-40	V
Gate-Source Voltage	$V_{GS}$	$\pm 20$	$\pm 20$	V
Continuous Drain Current	$I_D$	$T_A = 25^\circ C$	8	-7
		$T_A = 70^\circ C$	6	-5.5
Pulsed Drain Current (Note 1)	$I_{DM}$	40	-30	A
Maximum Power Dissipation	$P_D$	2.0	2.0	W
Operating Junction and Storage Temperature Range	$T_J, T_{STG}$	-55 To 150	-55 To 150	$^\circ C$

Thermal Characteristic

Thermal Resistance, Junction-to-Ambient (Note 2)	$R_{\theta JA}$	N-Ch	62.5	$^\circ C/W$
Thermal Resistance, Junction-to-Ambient (Note 2)	$R_{\theta JA}$	P-Ch	62.5	$^\circ C/W$



**N-CH Electrical Characteristics (T<sub>A</sub>=25°C unless otherwise noted)**

Parameter	Symbol	Condition	Min	Typ	Max	Unit
<b>Off Characteristics</b>						
Drain-Source Breakdown Voltage	BV <sub>DSS</sub>	V <sub>GS</sub> =0V, I <sub>D</sub> =250μA	40	-	-	V
Zero Gate Voltage Drain Current	I <sub>DSS</sub>	V <sub>DS</sub> =40V, V <sub>GS</sub> =0V	-	-	1	μA
Gate-Body Leakage Current	I <sub>GSS</sub>	V <sub>GS</sub> =±20V, V <sub>DS</sub> =0V	-	-	±100	nA
<b>On Characteristics (Note 3)</b>						
Gate Threshold Voltage	V <sub>GS(th)</sub>	V <sub>DS</sub> =V <sub>GS</sub> , I <sub>D</sub> =250μA	1	1.5	2.0	V
Drain-Source On-State Resistance	R <sub>DS(ON)</sub>	V <sub>GS</sub> =10V, I <sub>D</sub> =8A	-	14	19	mΩ
		V <sub>GS</sub> =4.5V, I <sub>D</sub> =4A	-	19	29	mΩ
Forward Transconductance	g <sub>FS</sub>	V <sub>DS</sub> =5V, I <sub>D</sub> =8A	33	-	-	S
<b>Dynamic Characteristics (Note4)</b>						
Input Capacitance	C <sub>iss</sub>	V <sub>DS</sub> =20V, V <sub>GS</sub> =0V, F=1.0MHz	-	415	-	PF
Output Capacitance	C <sub>oss</sub>		-	112	-	PF
Reverse Transfer Capacitance	C <sub>rss</sub>		-	11	-	PF
<b>Switching Characteristics (Note 4)</b>						
Turn-on Delay Time	t <sub>d(on)</sub>	V <sub>DD</sub> =20V, R <sub>L</sub> =2.5Ω V <sub>GS</sub> =10V, R <sub>GEN</sub> =3Ω	-	4	-	nS
Turn-on Rise Time	t <sub>r</sub>		-	3	-	nS
Turn-Off Delay Time	t <sub>d(off)</sub>		-	15	-	nS
Turn-Off Fall Time	t <sub>f</sub>		-	2	-	nS
Total Gate Charge	Q <sub>g</sub>	V <sub>DS</sub> =20V, I <sub>D</sub> =8A, V <sub>GS</sub> =10V	-	12	-	nC
Gate-Source Charge	Q <sub>gs</sub>		-	3.2	-	nC
Gate-Drain Charge	Q <sub>gd</sub>		-	3.1	-	nC
<b>Drain-Source Diode Characteristics</b>						
Diode Forward Voltage (Note 3)	V <sub>SD</sub>	V <sub>GS</sub> =0V, I <sub>S</sub> =8A	-	0.8	1.2	V

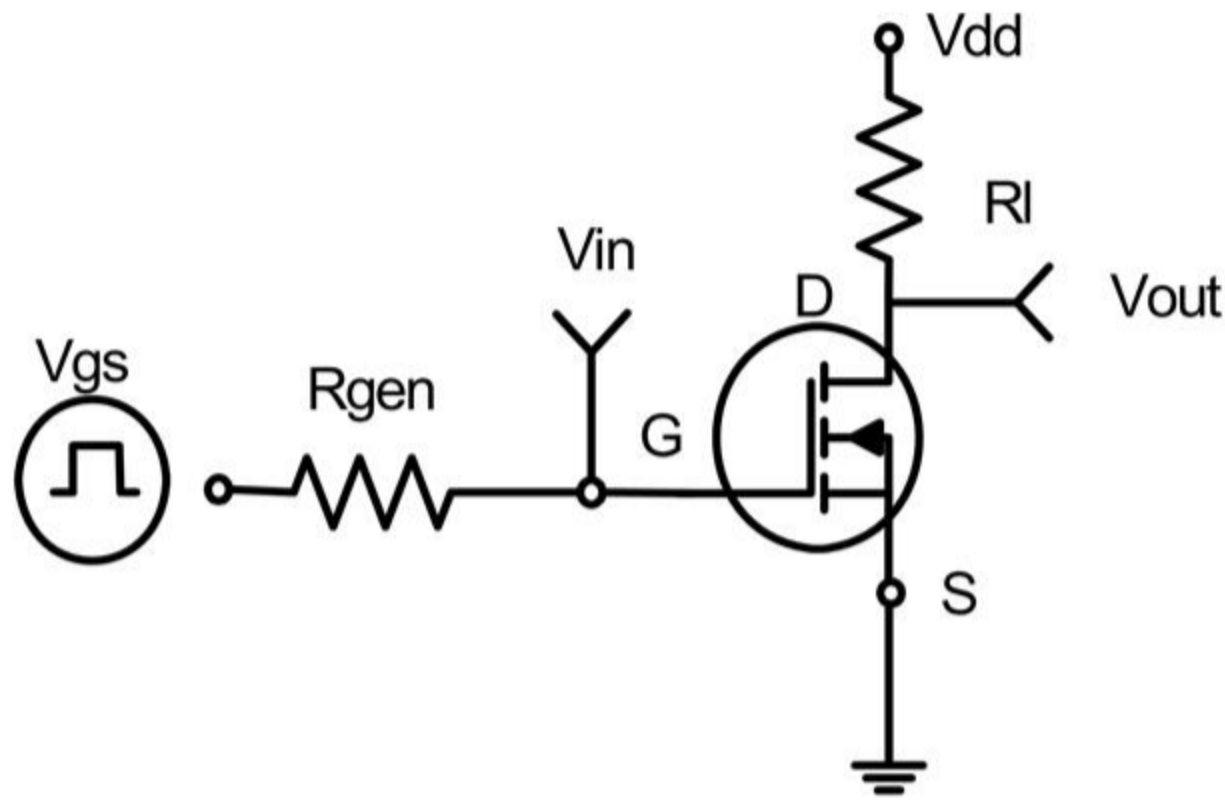


**P-CH Electrical Characteristics ( $T_A=25^\circ\text{C}$  unless otherwise noted)**

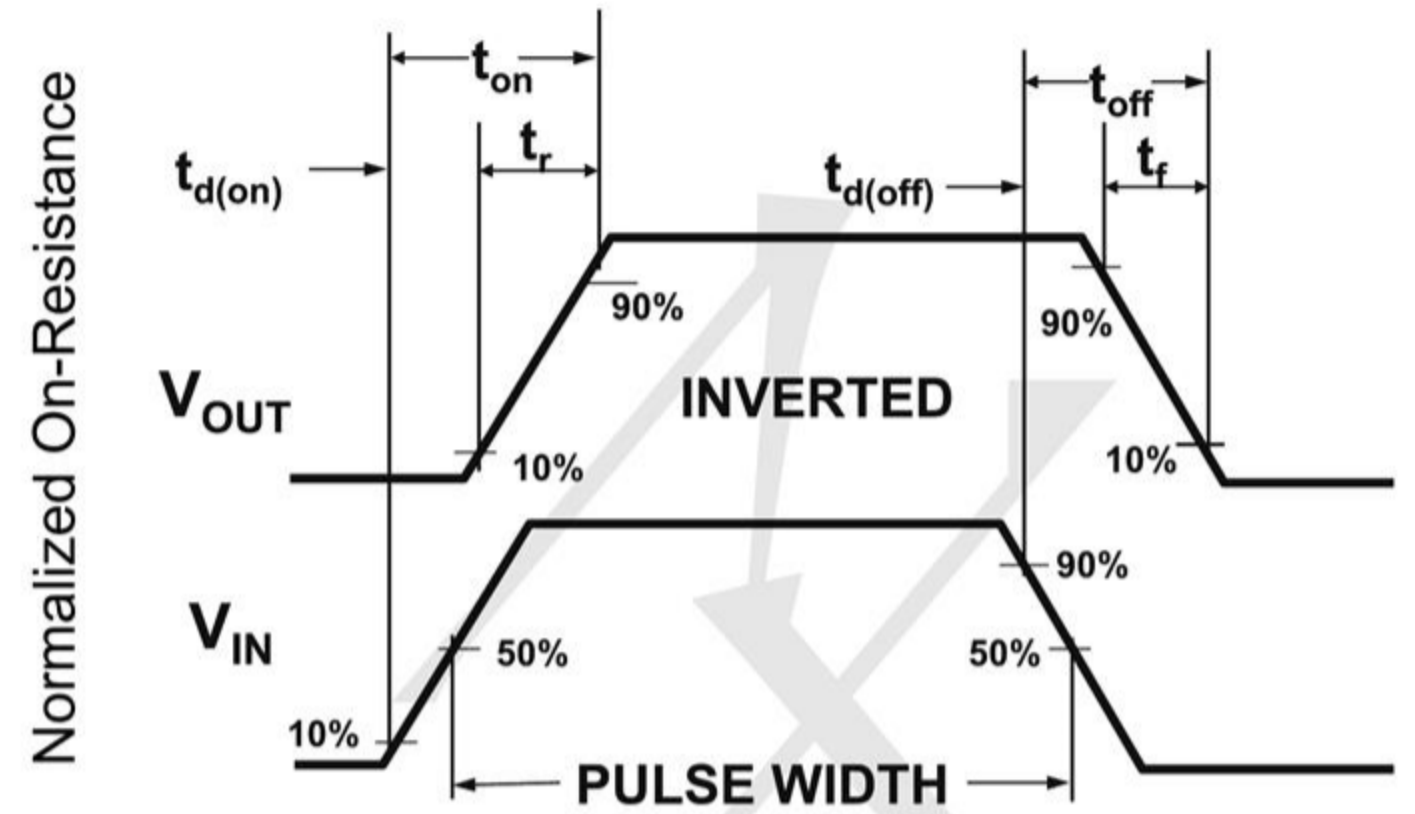
Parameter	Symbol	Condition	Min	Typ	Max	Unit
<b>Off Characteristics</b>						
Drain-Source Breakdown Voltage	$BV_{DSS}$	$V_{GS}=0V, I_D=-250\mu A$	-40	-	-	V
Zero Gate Voltage Drain Current	$I_{DSS}$	$V_{DS}=-40V, V_{GS}=0V$	-	-	-1	$\mu A$
Gate-Body Leakage Current	$I_{GSS}$	$V_{GS}=\pm 20V, V_{DS}=0V$	-	-	$\pm 100$	nA
<b>On Characteristics (Note 3)</b>						
Gate Threshold Voltage	$V_{GS(th)}$	$V_{DS}=V_{GS}, I_D=-250\mu A$	-1.0	-1.5	-2.0	V
Drain-Source On-State Resistance	$R_{DS(on)}$	$V_{GS}=-10V, I_D=-8A$	-	29	35	m $\Omega$
		$V_{GS}=-4.5V, I_D=-4A$	-	34	45	m $\Omega$
Forward Transconductance	$g_{FS}$	$V_{DS}=-5V, I_D=-8A$	20	-	-	S
<b>Dynamic Characteristics (Note 4)</b>						
Input Capacitance	$C_{iss}$	$V_{DS}=-20V, V_{GS}=0V,$ $F=1.0\text{MHz}$	-	520	-	PF
Output Capacitance	$C_{oss}$		-	100	-	PF
Reverse Transfer Capacitance	$C_{rss}$		-	65	-	PF
<b>Switching Characteristics (Note 4)</b>						
Turn-on Delay Time	$t_{d(on)}$	$V_{DD}=-20V, R_L=2.3\Omega$ $V_{GS}=-10V, R_{GEN}=6\Omega$	-	7.5	-	nS
Turn-on Rise Time	$t_r$		-	5.5	-	nS
Turn-Off Delay Time	$t_{d(off)}$		-	19	-	nS
Turn-Off Fall Time	$t_f$		-	7	-	nS
Total Gate Charge	$Q_g$	$V_{DS}=-20V, I_D=-8A$ $V_{GS}=-10V$	-	13	-	nC
Gate-Source Charge	$Q_{gs}$		-	3.8	-	nC
Gate-Drain Charge	$Q_{gd}$		-	3.1	-	nC
<b>Drain-Source Diode Characteristics</b>						
Diode Forward Voltage (Note 3)	$V_{SD}$	$V_{GS}=0V, I_S=-10A$	-	-	-1.2	V



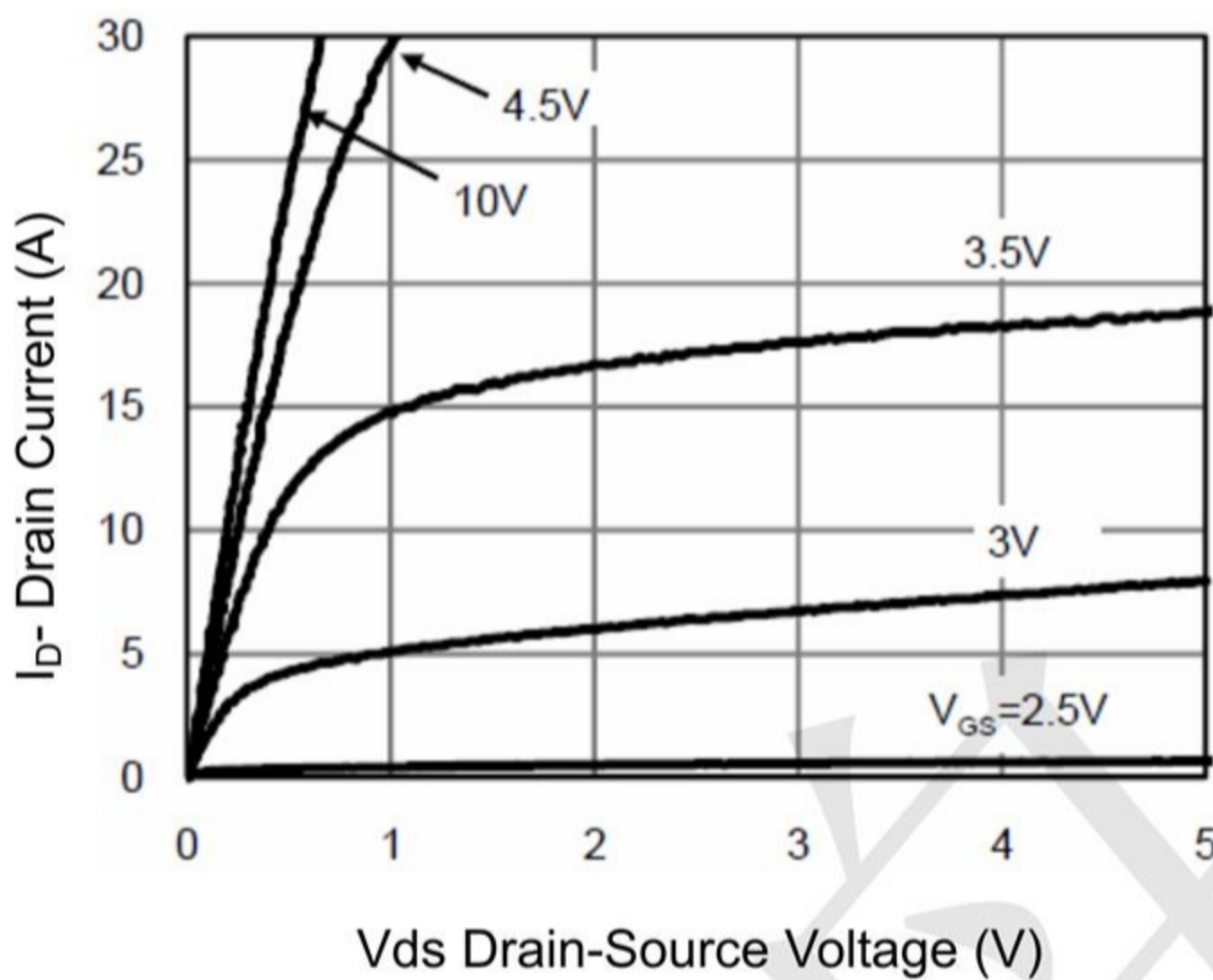
**N- Channel Typical Electrical and Thermal Characteristics (Curves)**



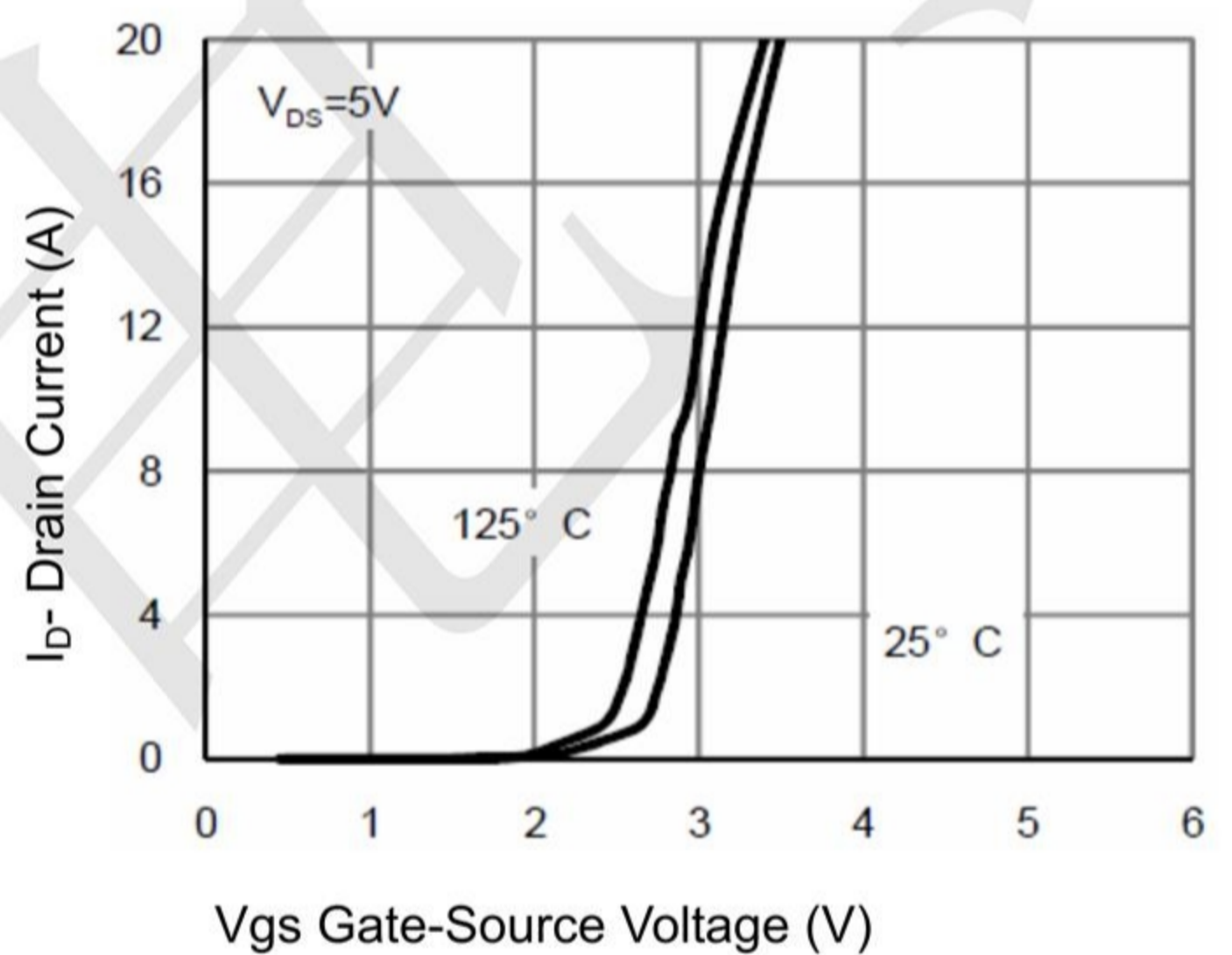
**Figure 1: Switching Test Circuit**



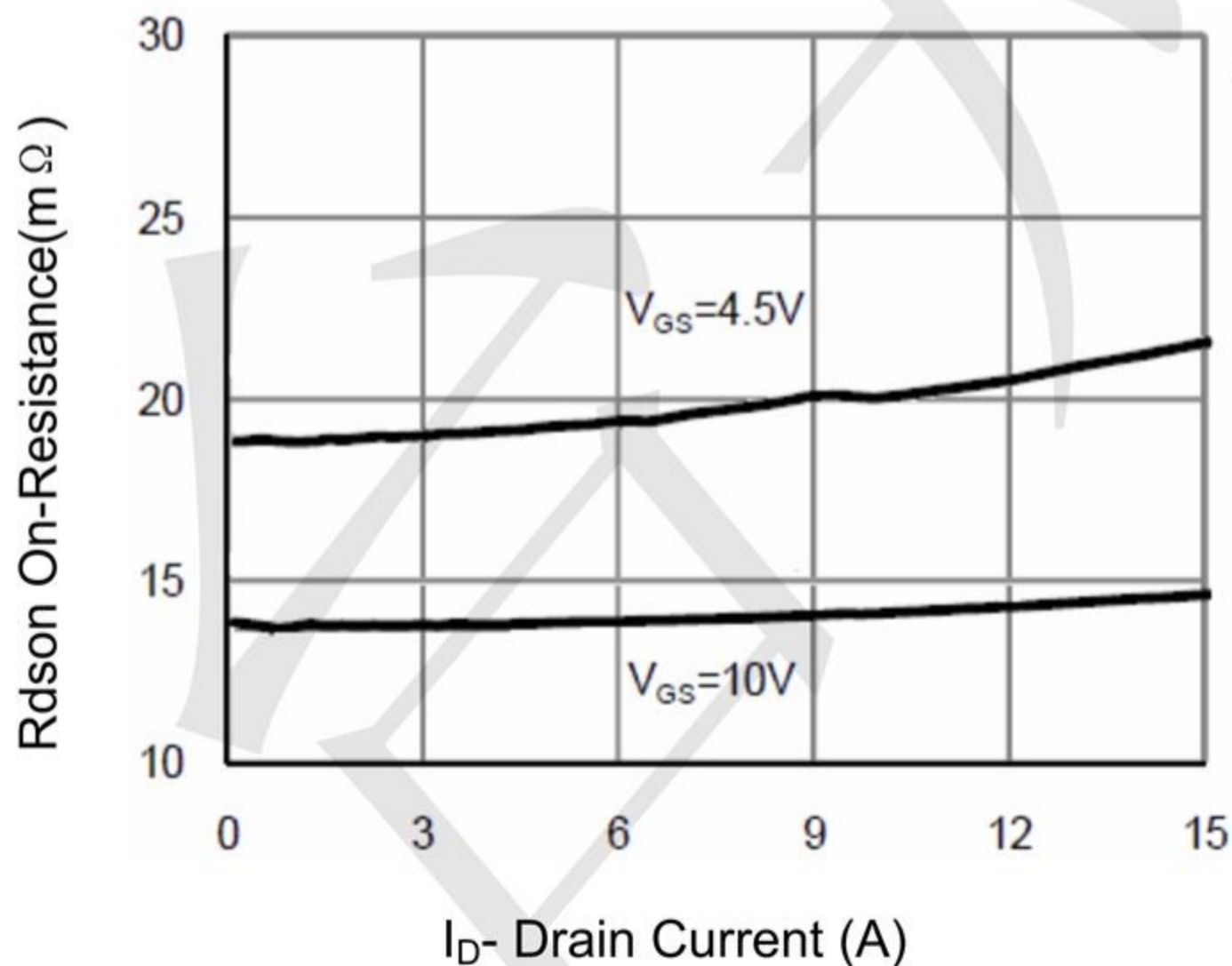
**Figure 2: Switching Waveforms**



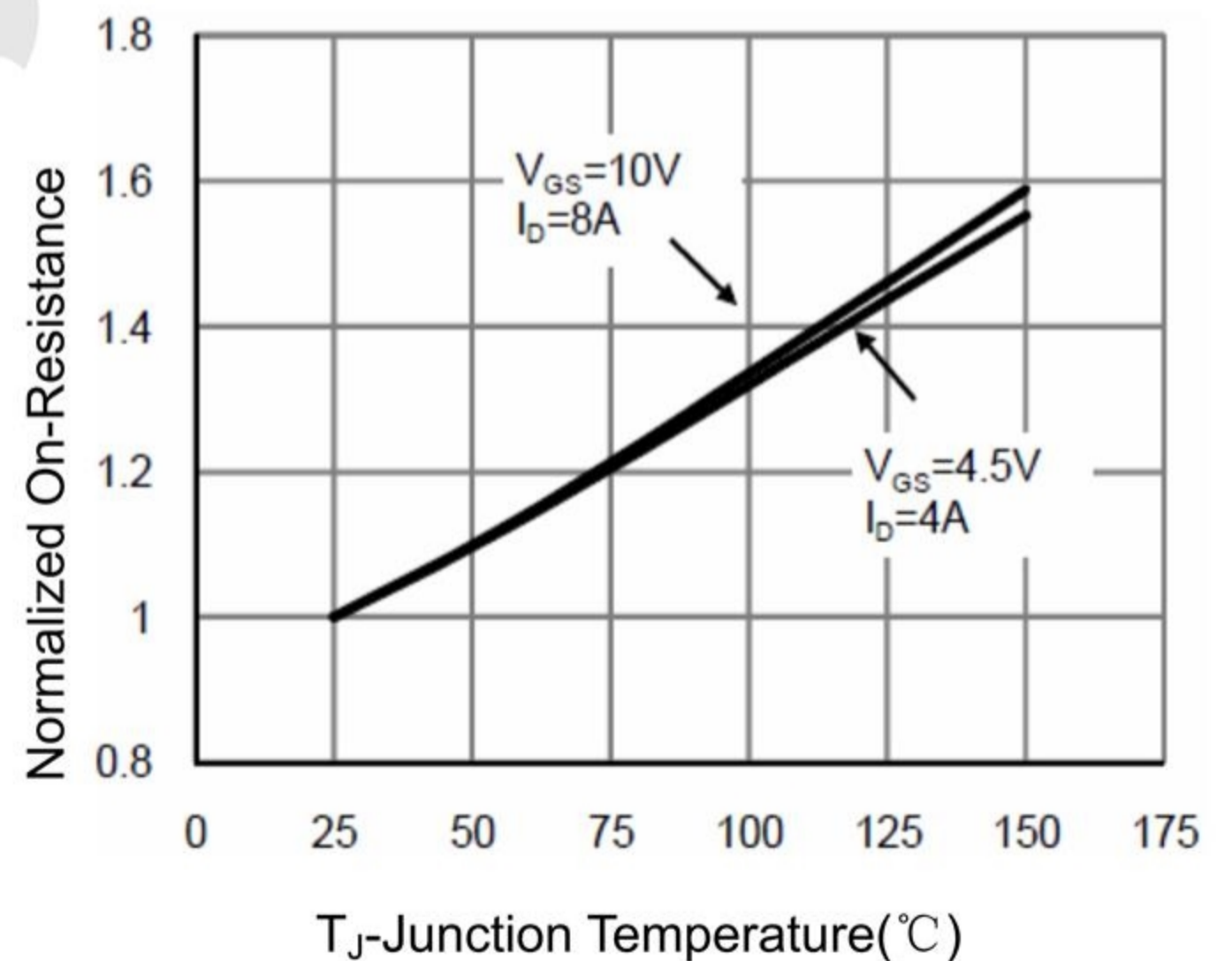
**Figure 3 Output Characteristics**



**Figure 4 Transfer Characteristics**

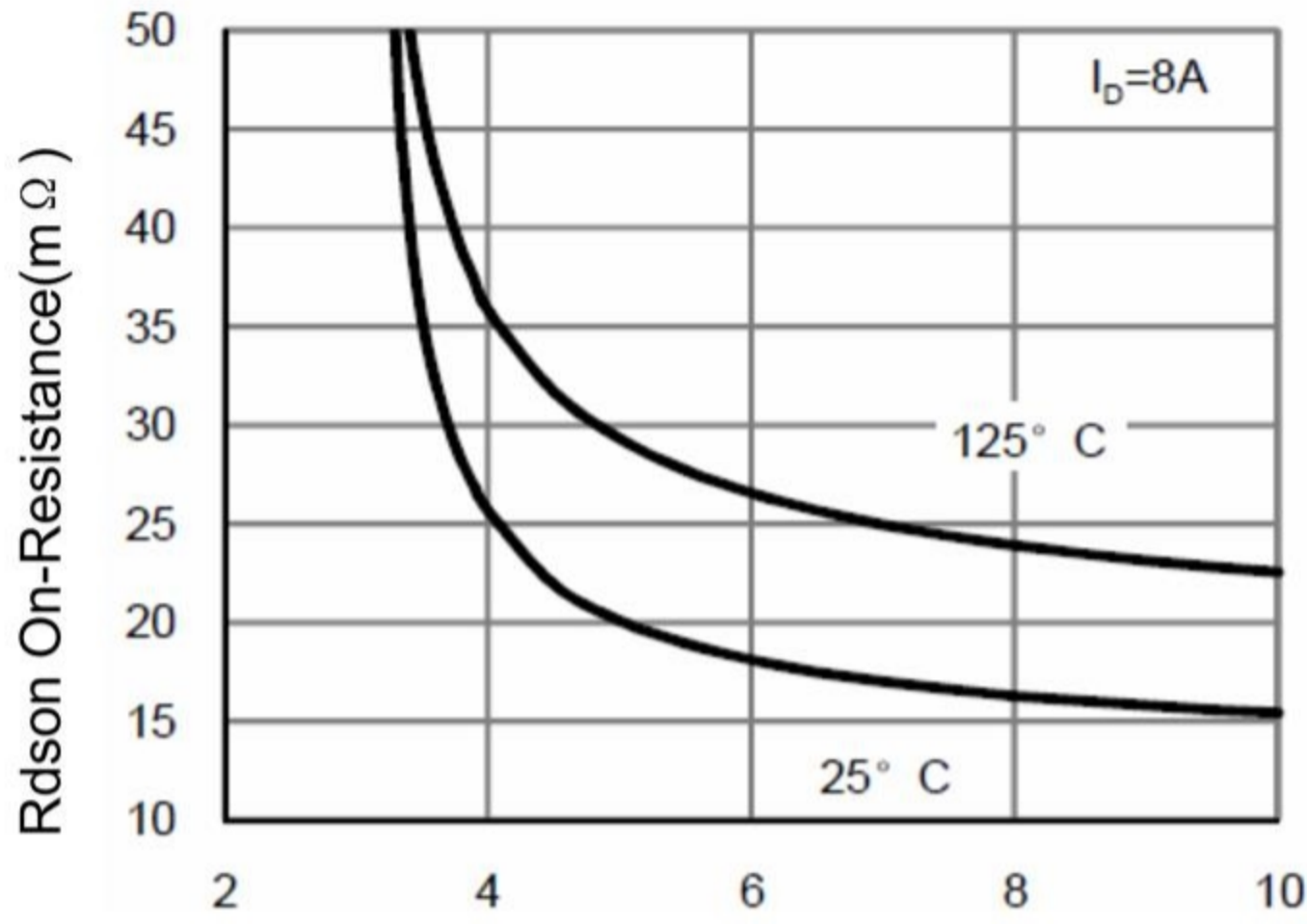


**Figure 5 Drain-Source On-Resistance**

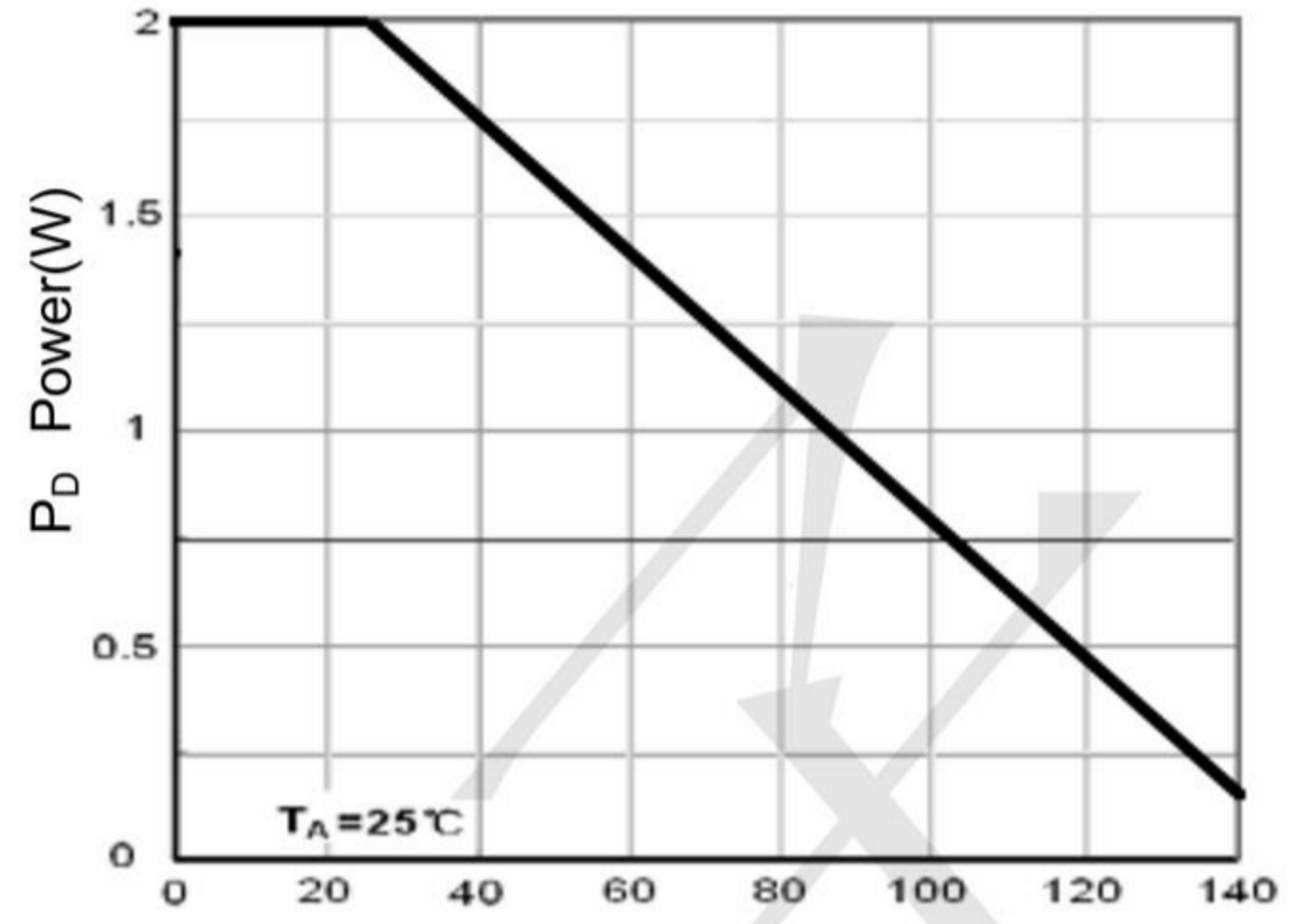


**Figure 6 Drain-Source On-Resistance**

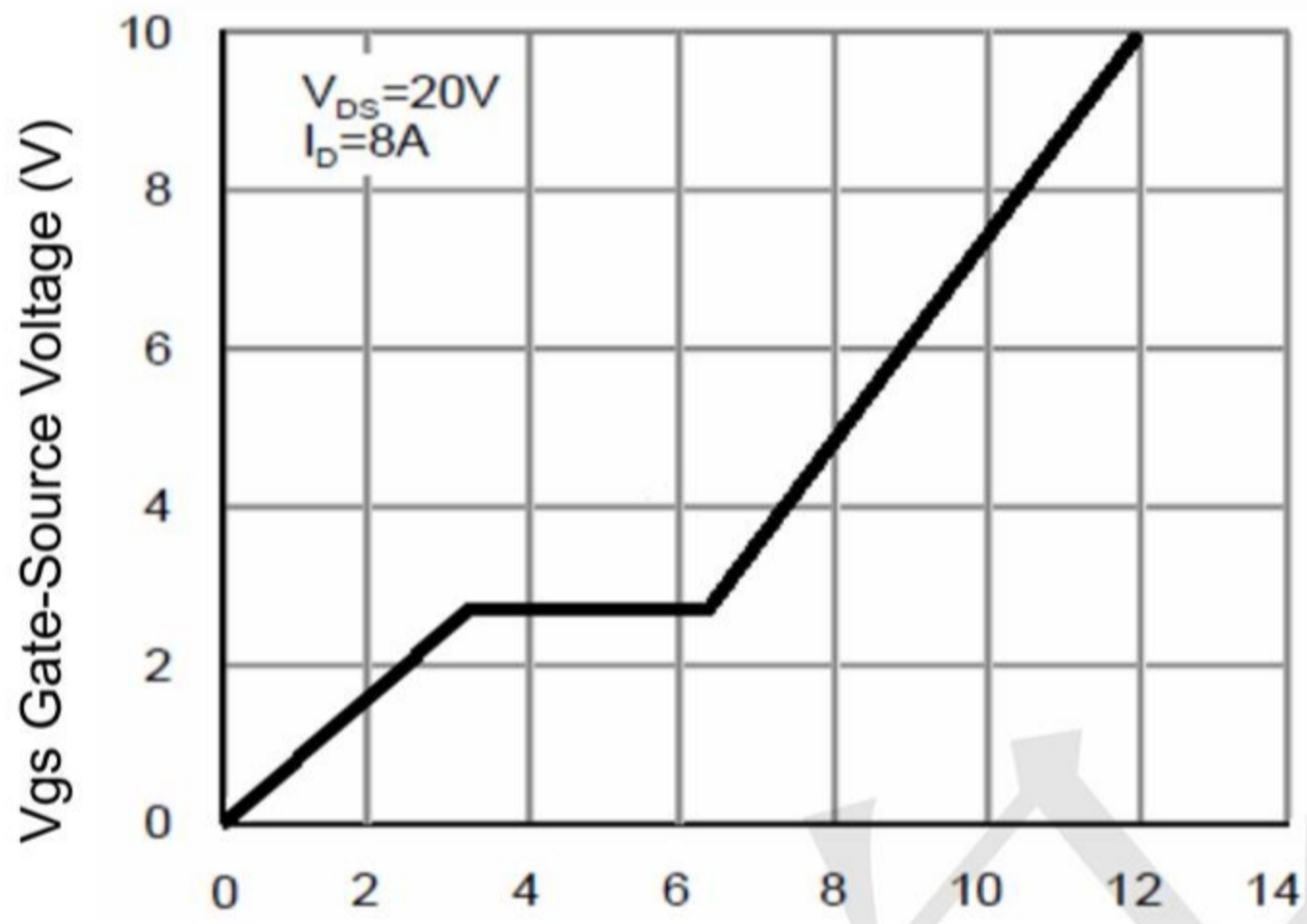




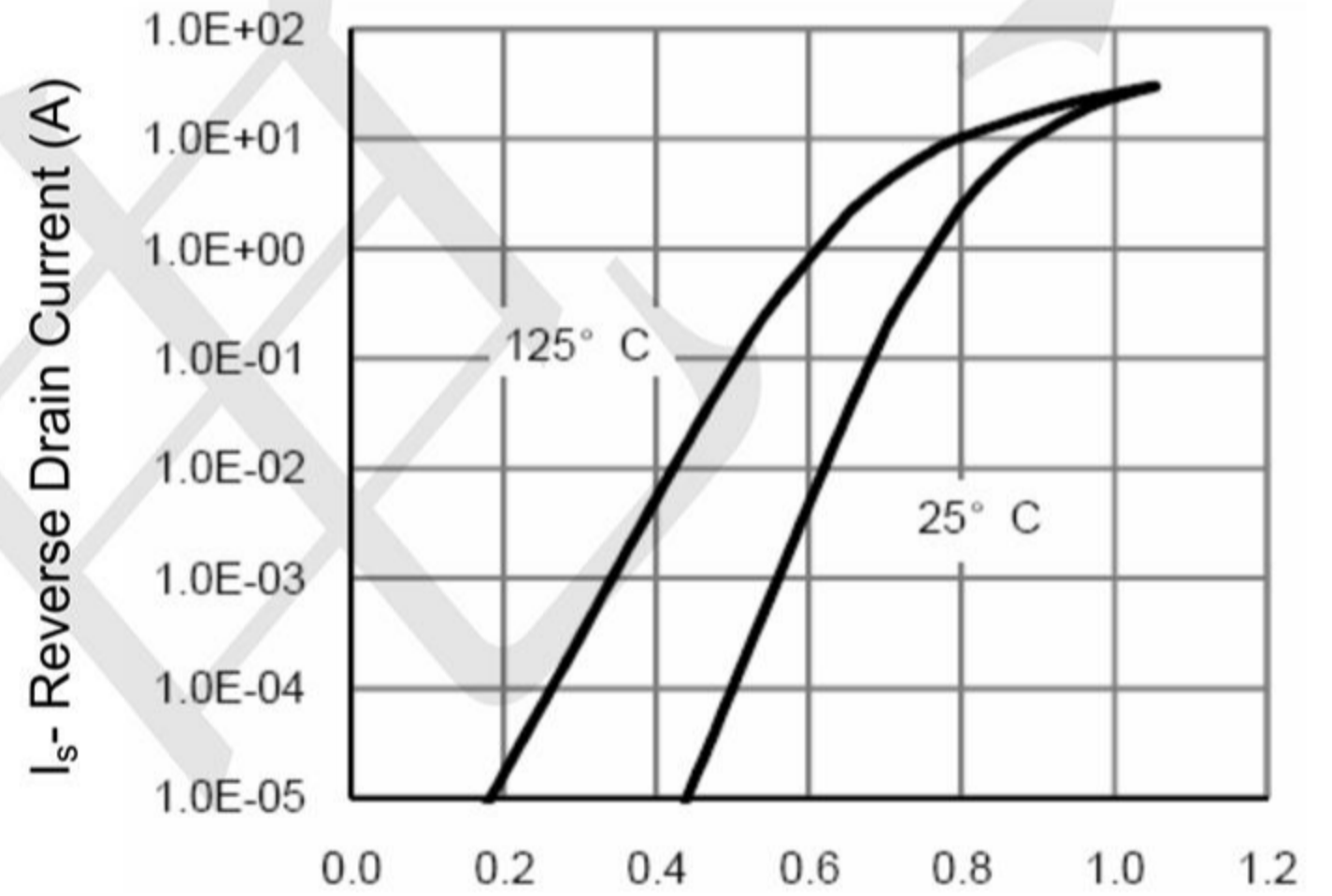
Vgs Gate-Source Voltage (V)  
Figure 7 Rdson vs Vgs



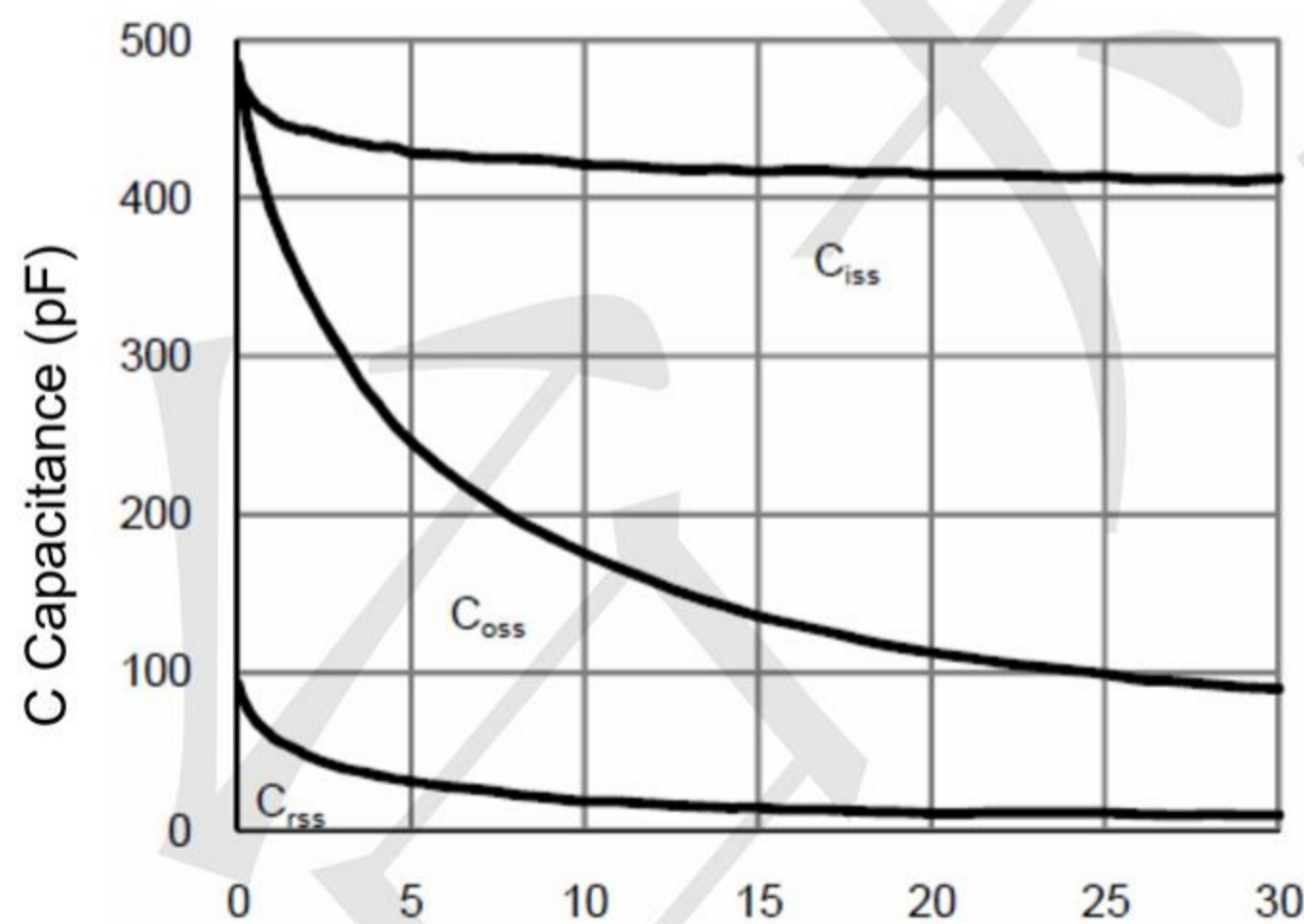
T<sub>J</sub>-Junction Temperature (°C)  
Figure 8 Power Dissipation



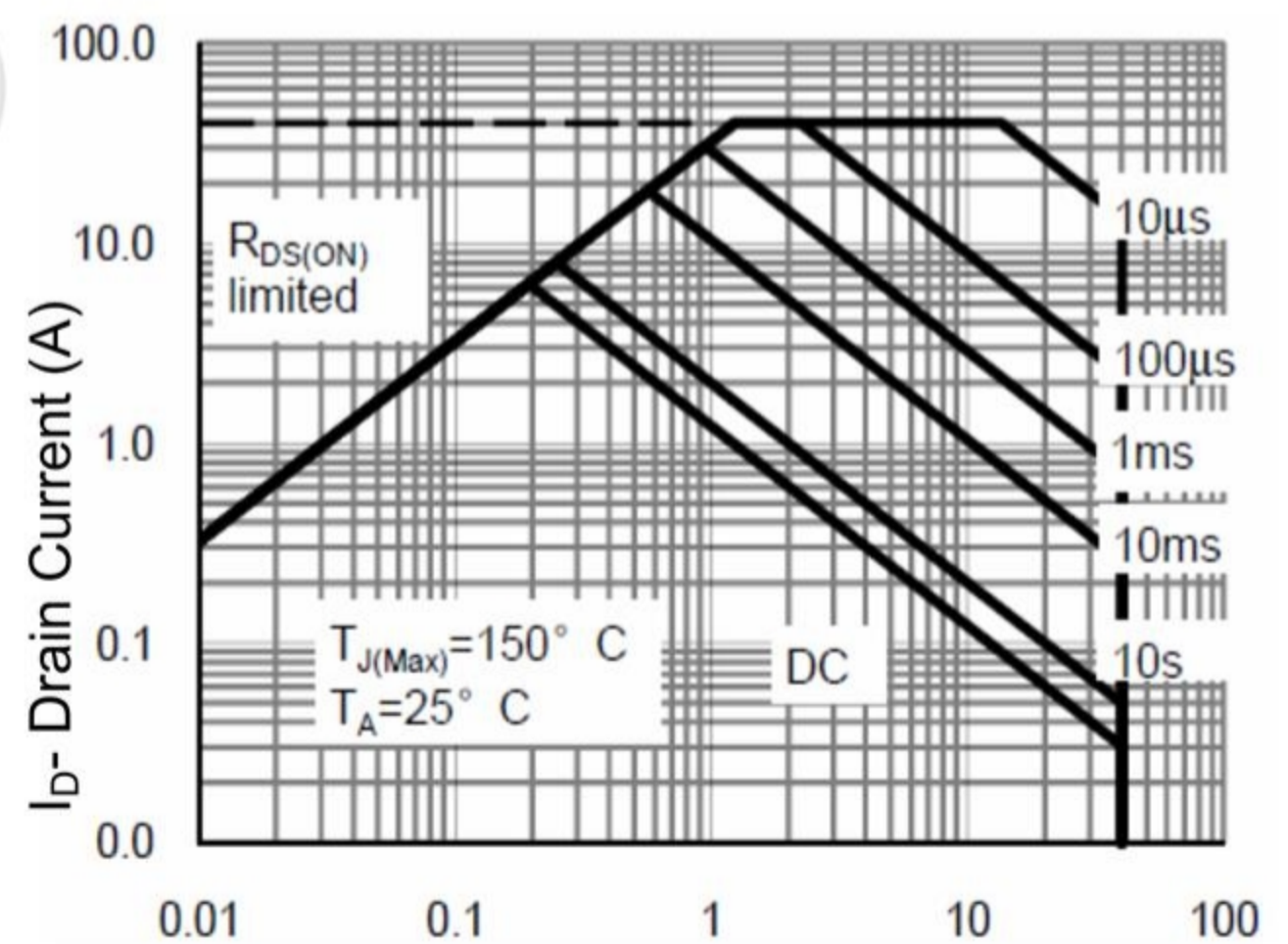
Qg Gate Charge (nC)  
Figure 9 Gate Charge



Vds Drain-Source Voltage (V)  
Figure 10 Source-Drain Diode Forward



Vds Drain-Source Voltage (V)  
Figure 11 Capacitance vs Vds



Vds Drain-Source Voltage (V)  
Figure 12 Safe Operation Area



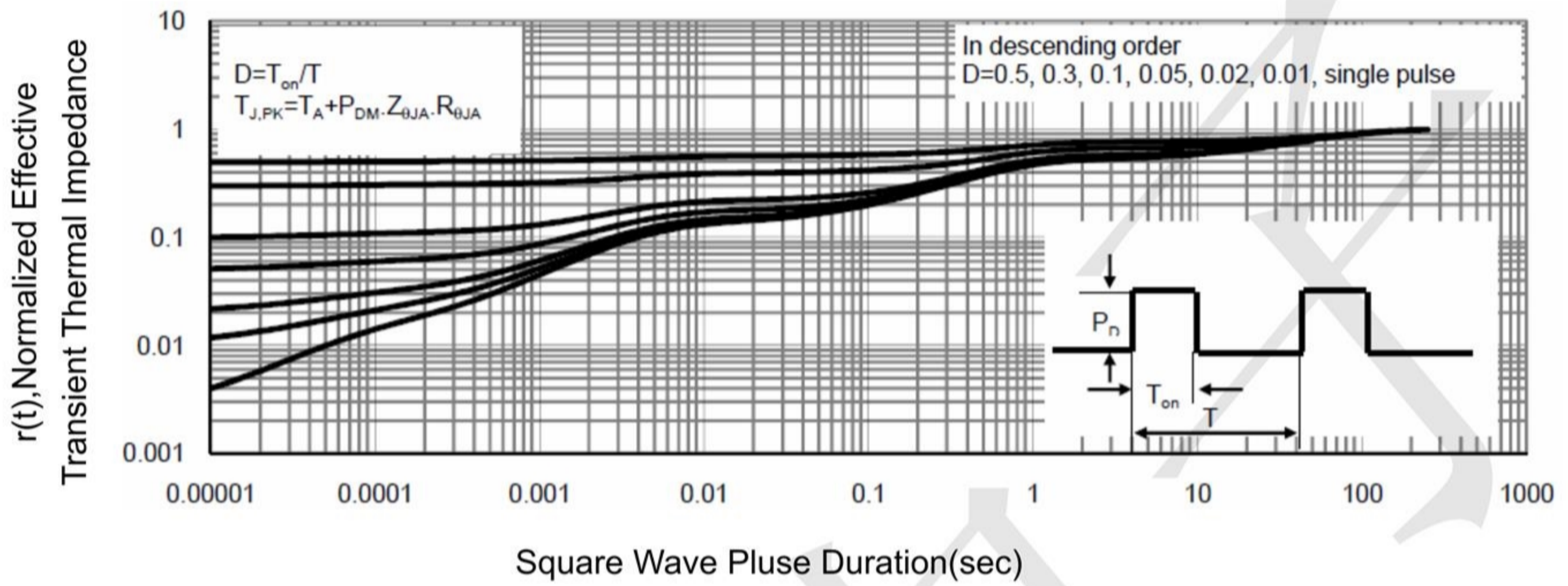


Figure 13 Normalized Maximum Transient Thermal Impedance





P- Channel Typical Electrical and Thermal Characteristics (Curves)

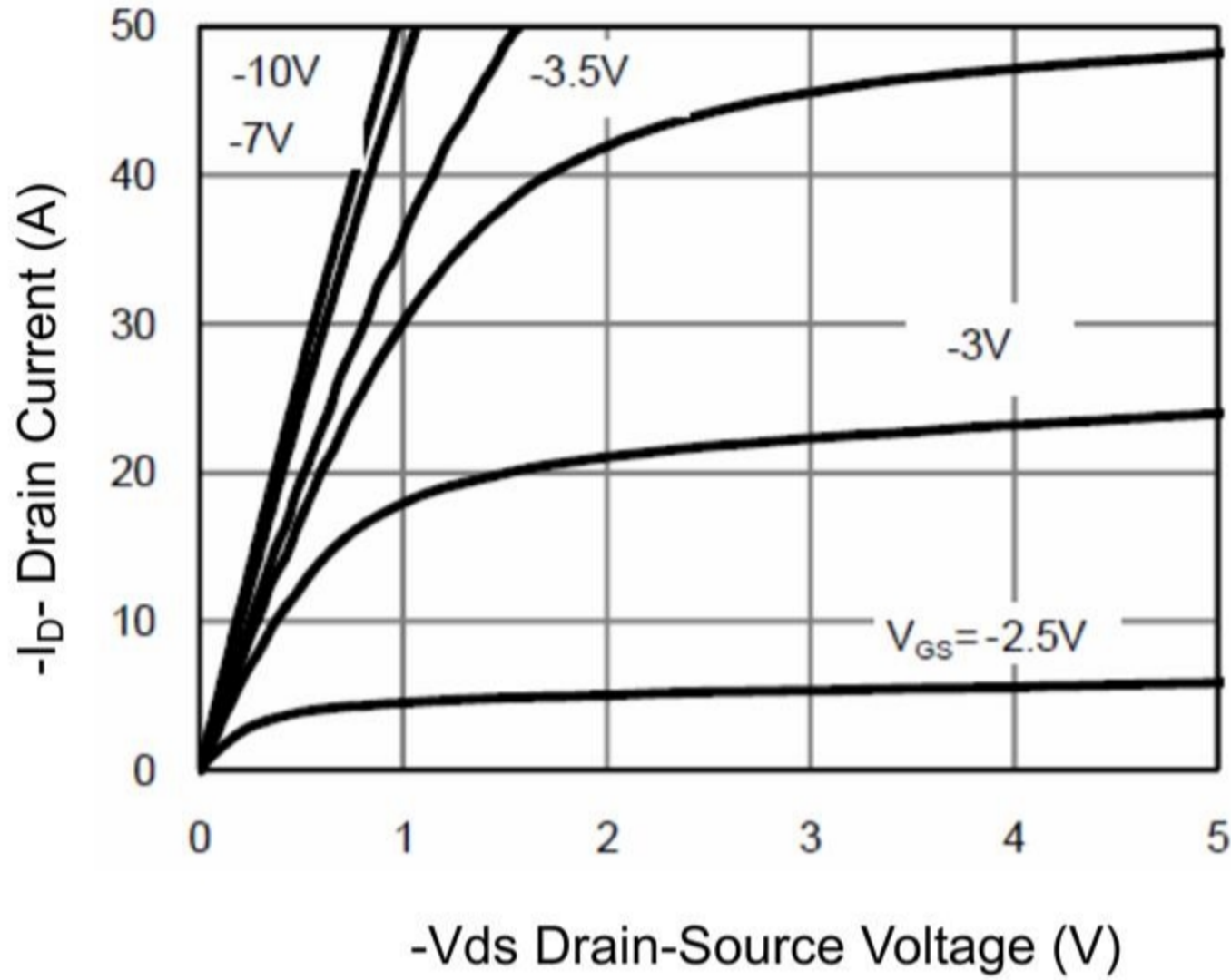


Figure 1 Output Characteristics

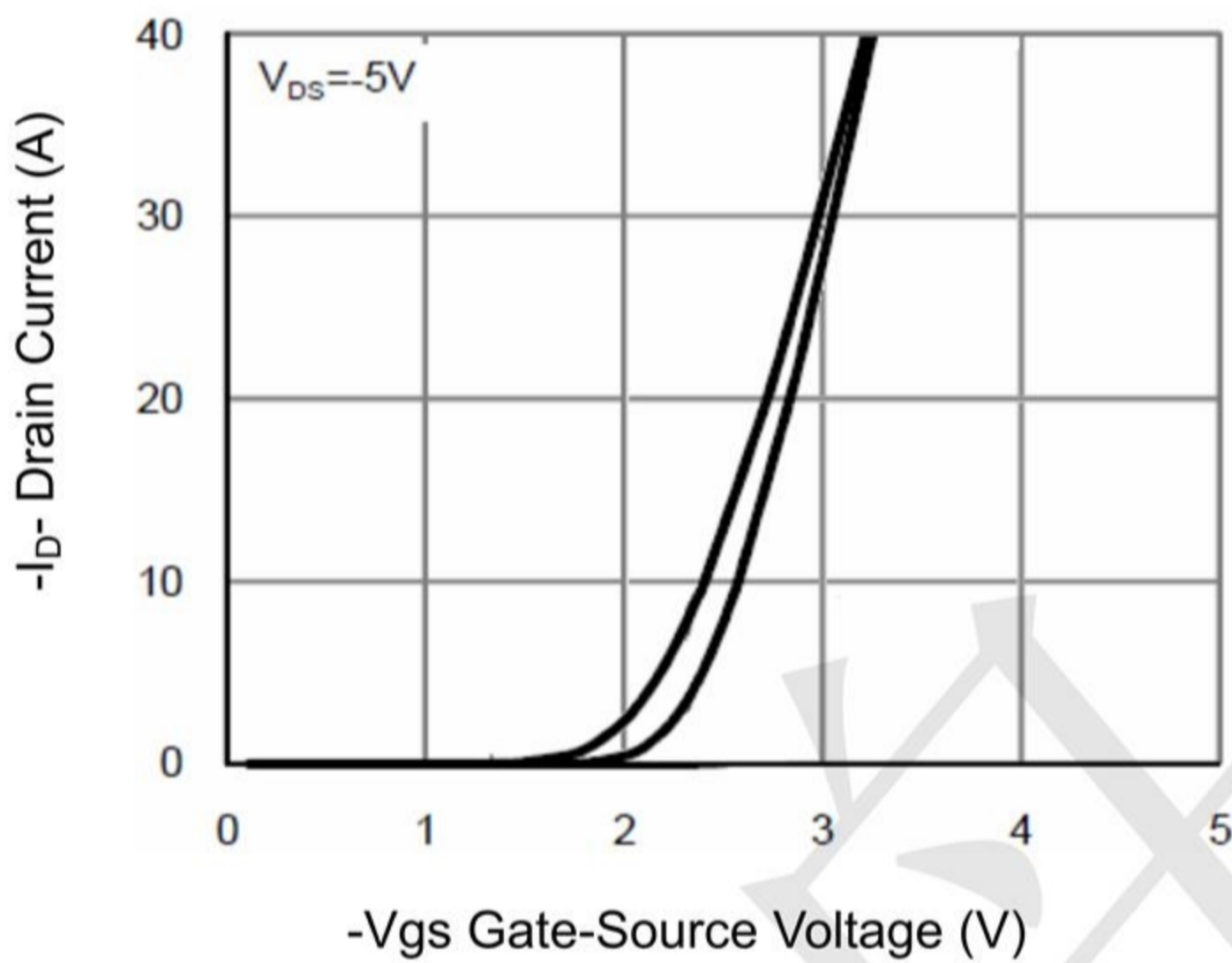


Figure 2 Transfer Characteristics

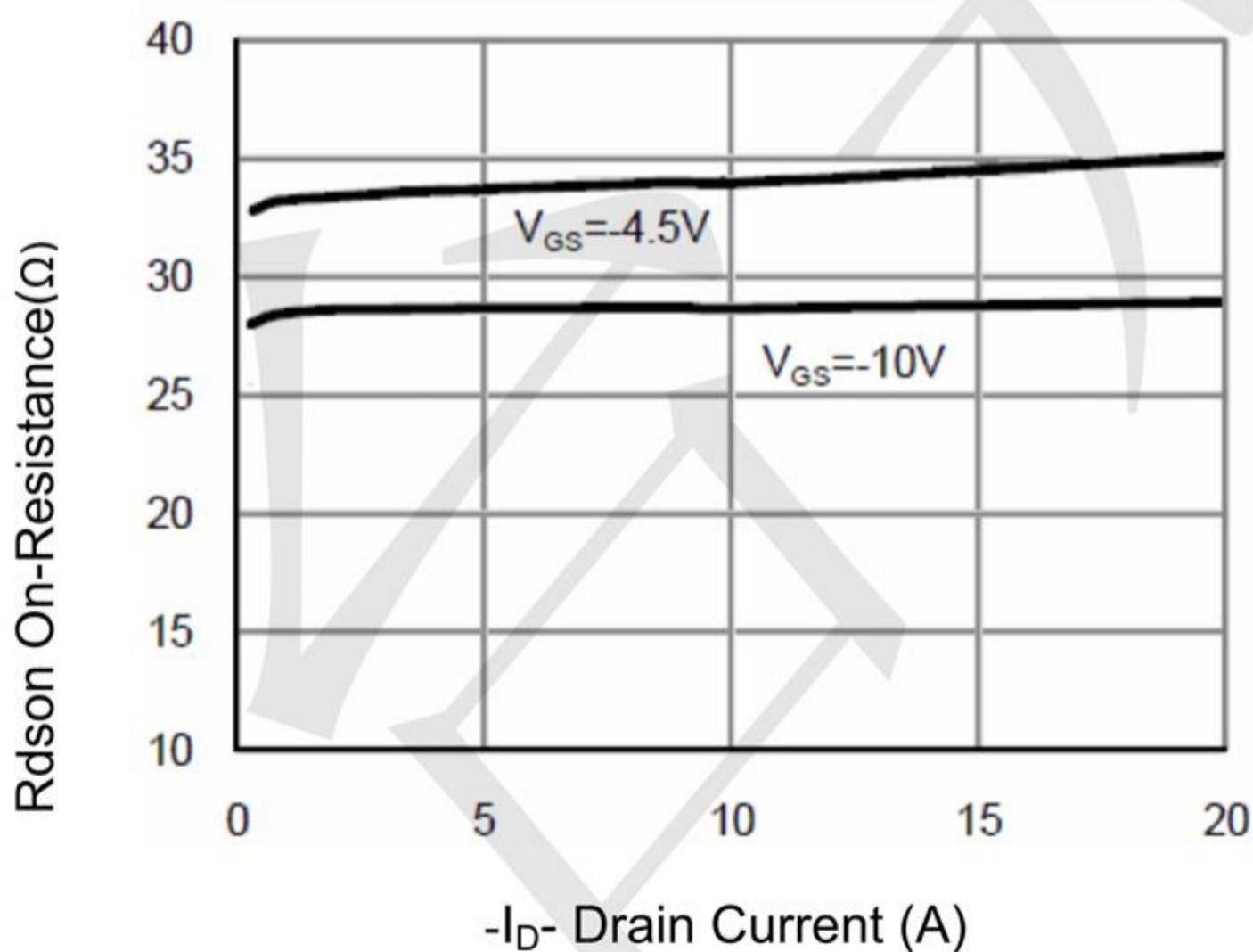


Figure 3 Rdson- Drain Current

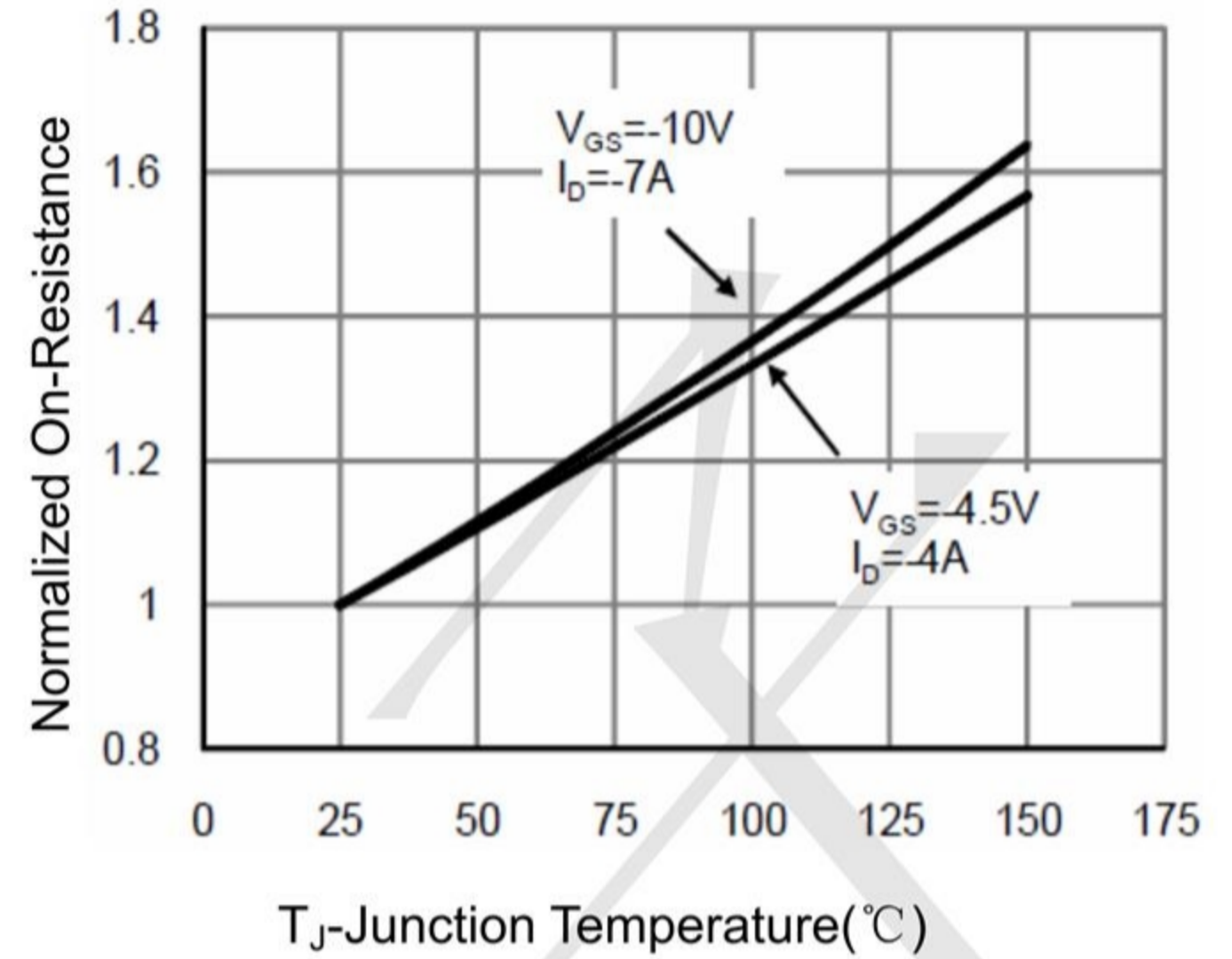


Figure 4 Rdson-Junction Temperature

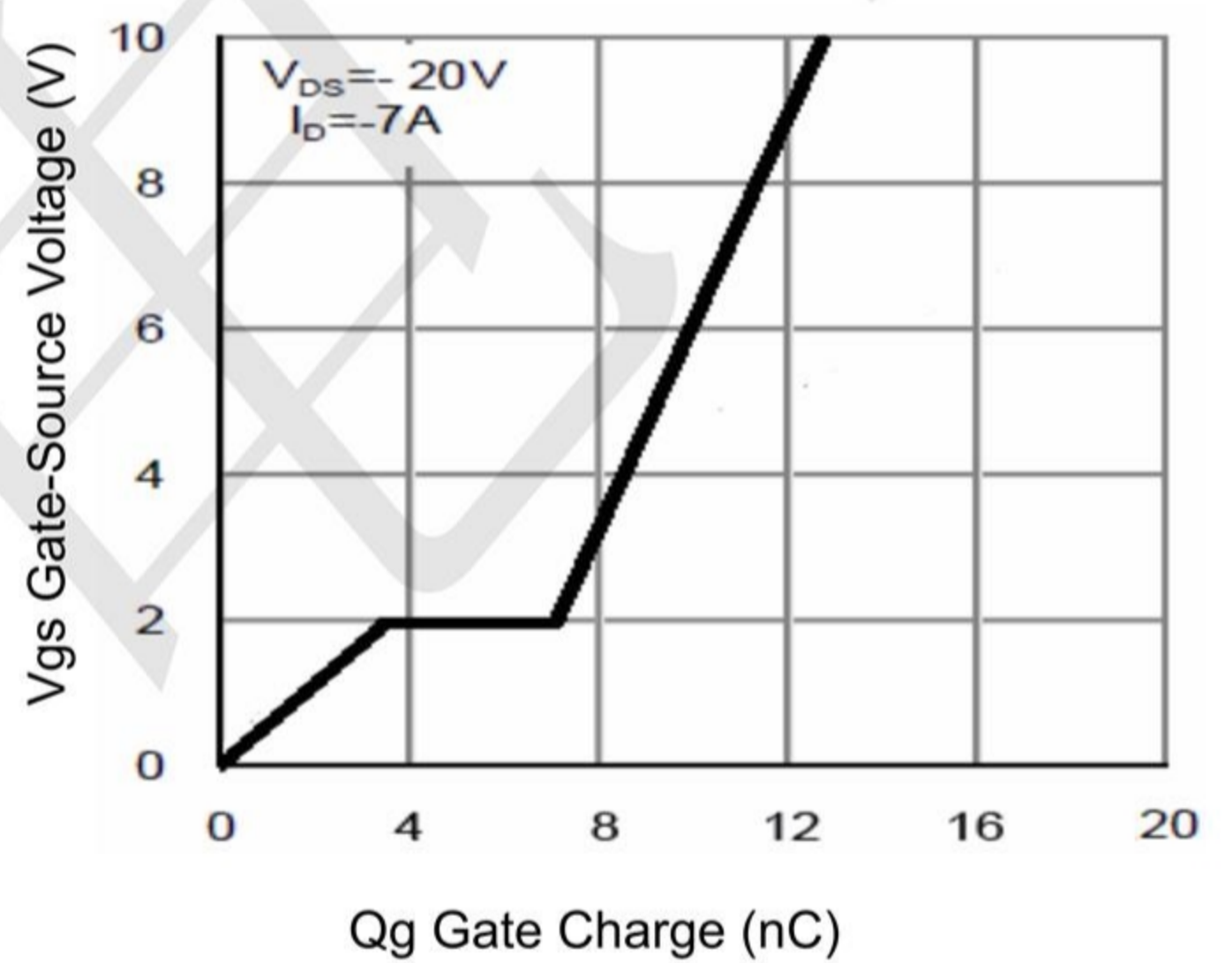


Figure 5 Gate Charge

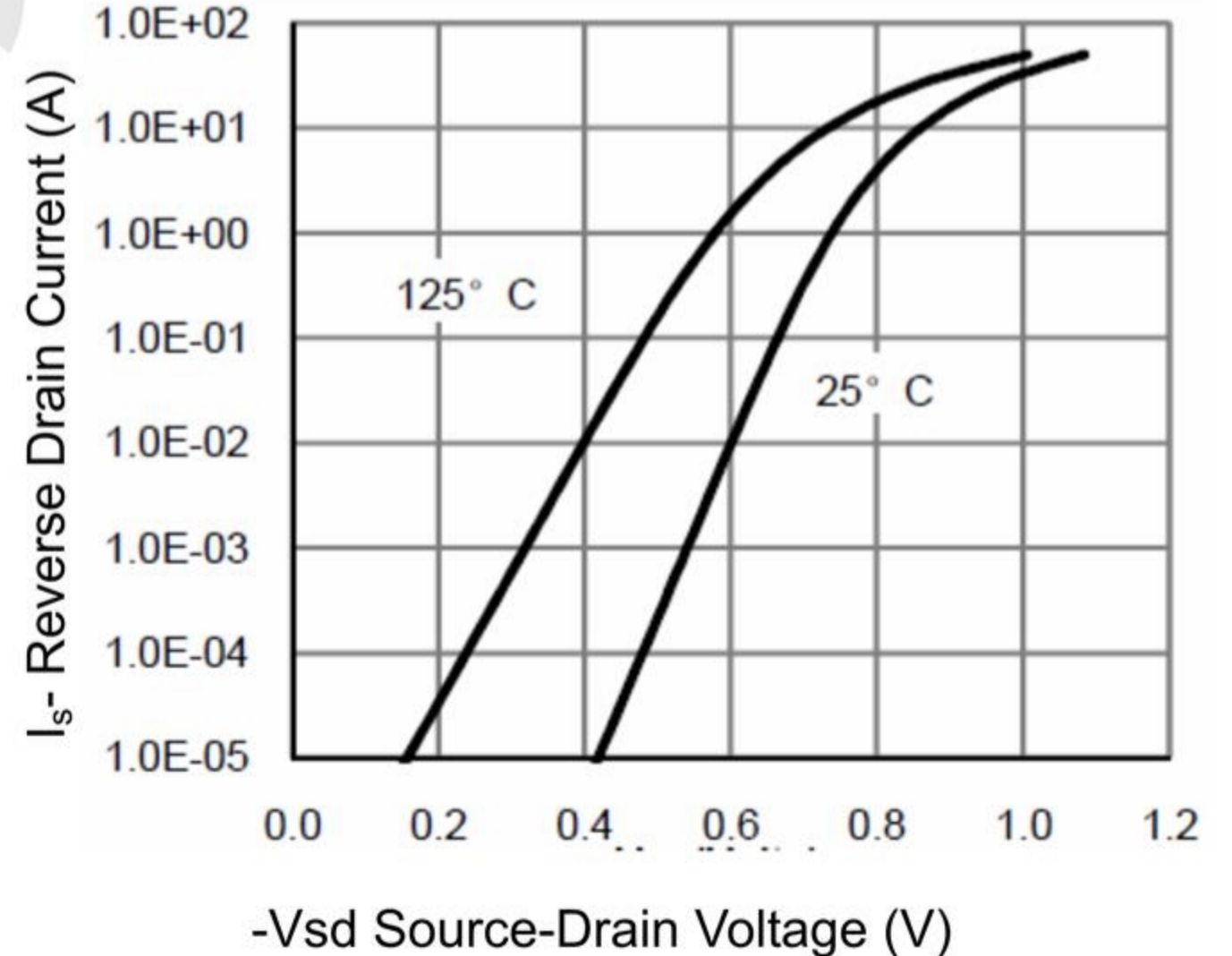
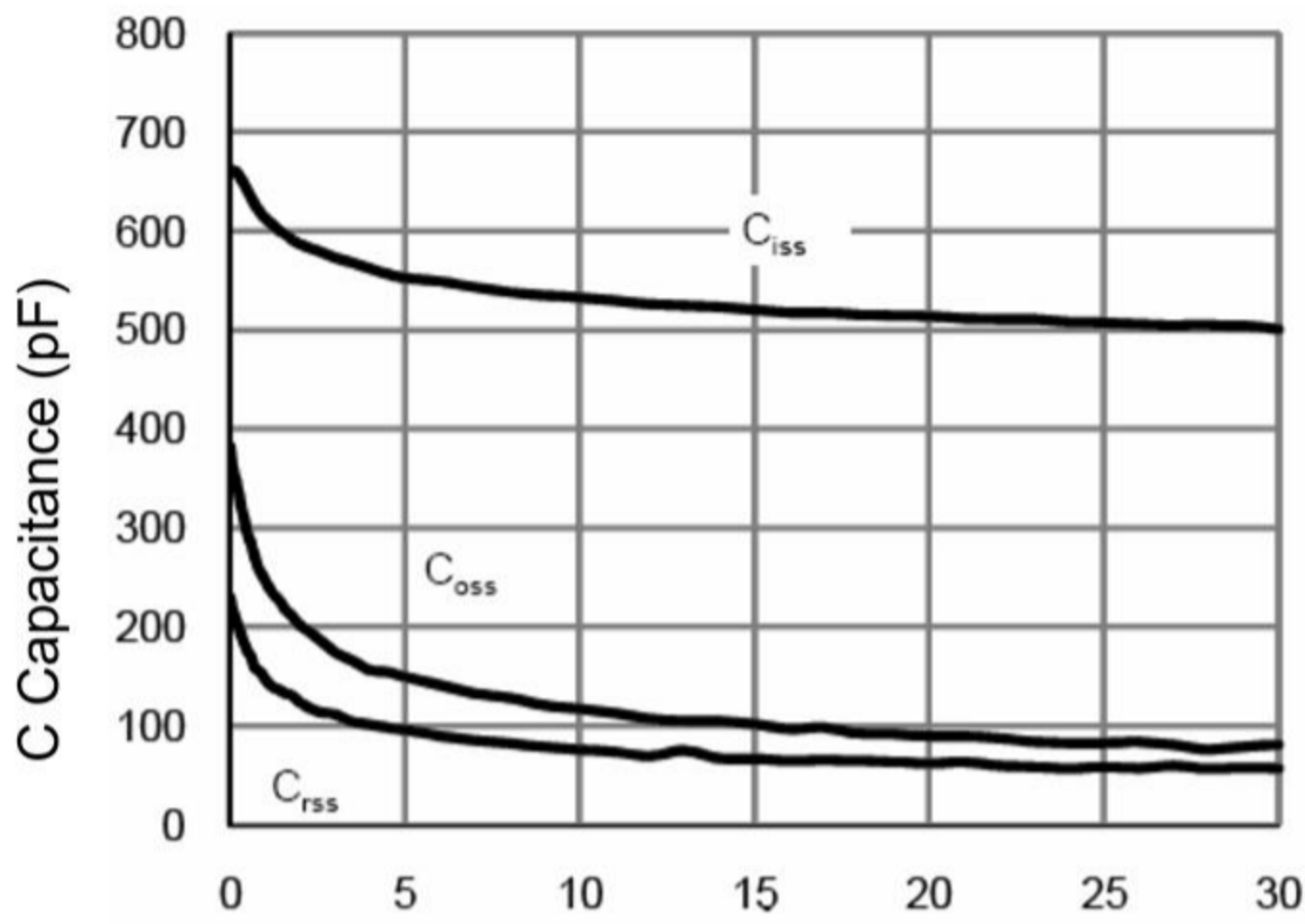
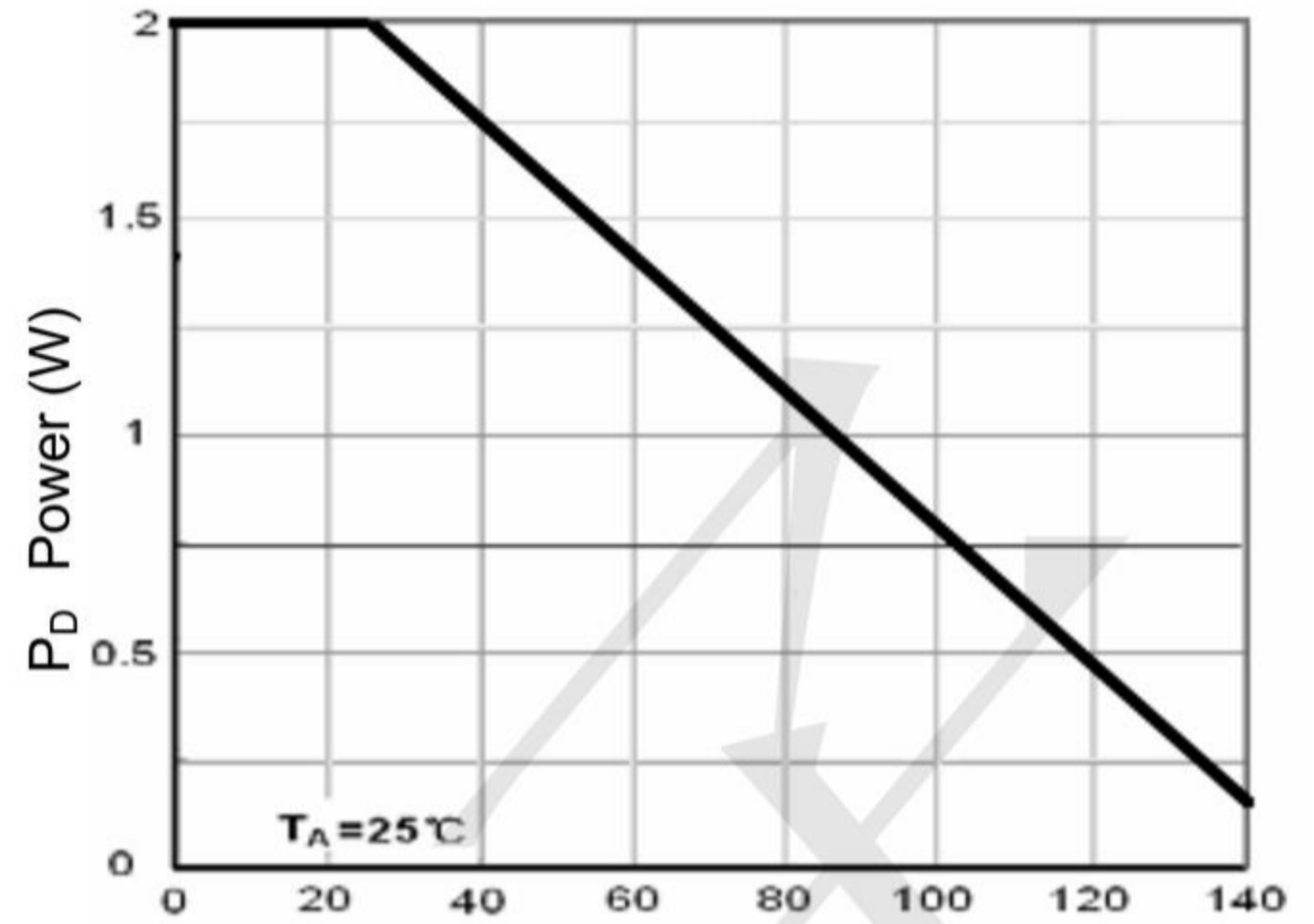


Figure 6 Source- Drain Diode Forward

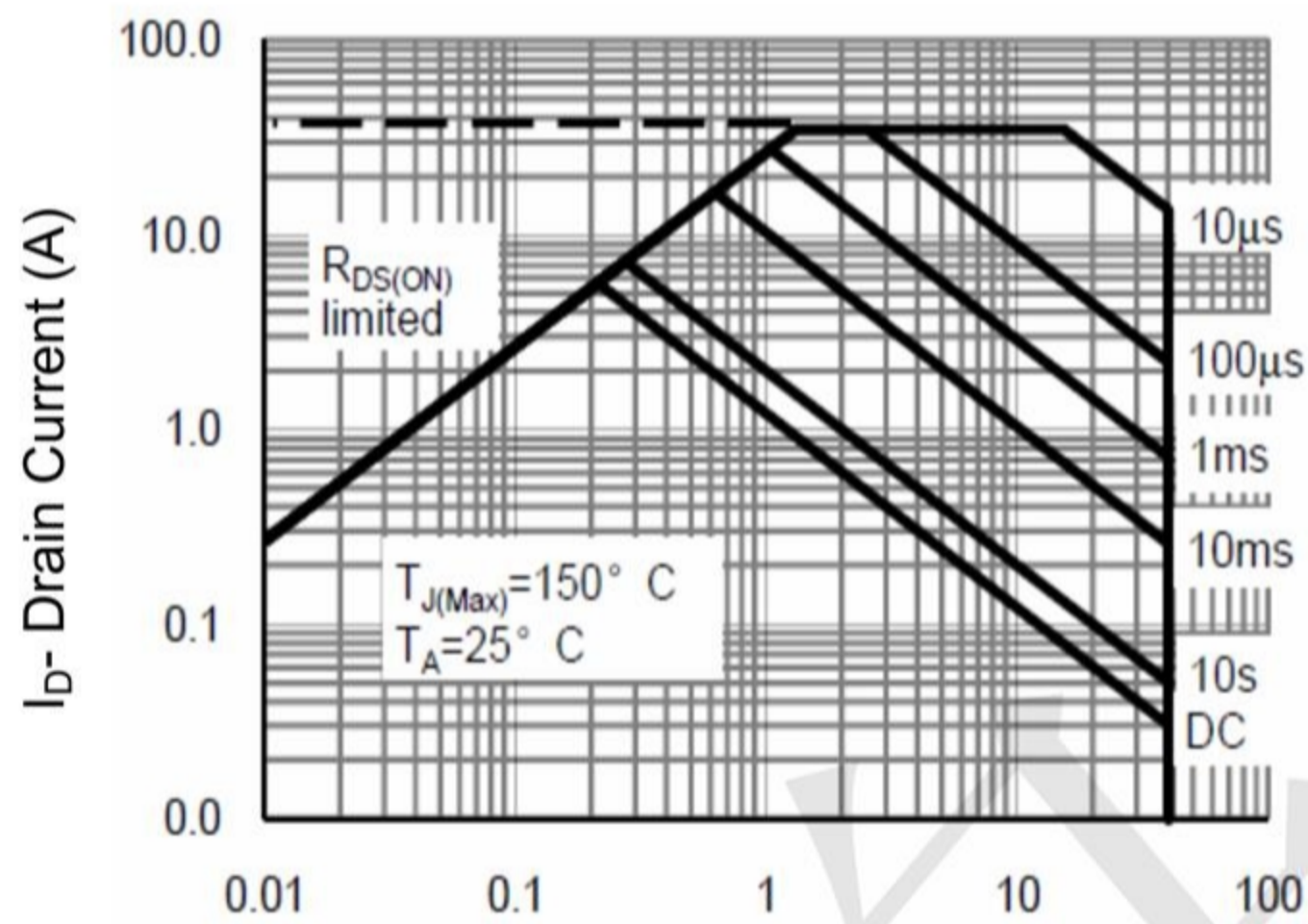




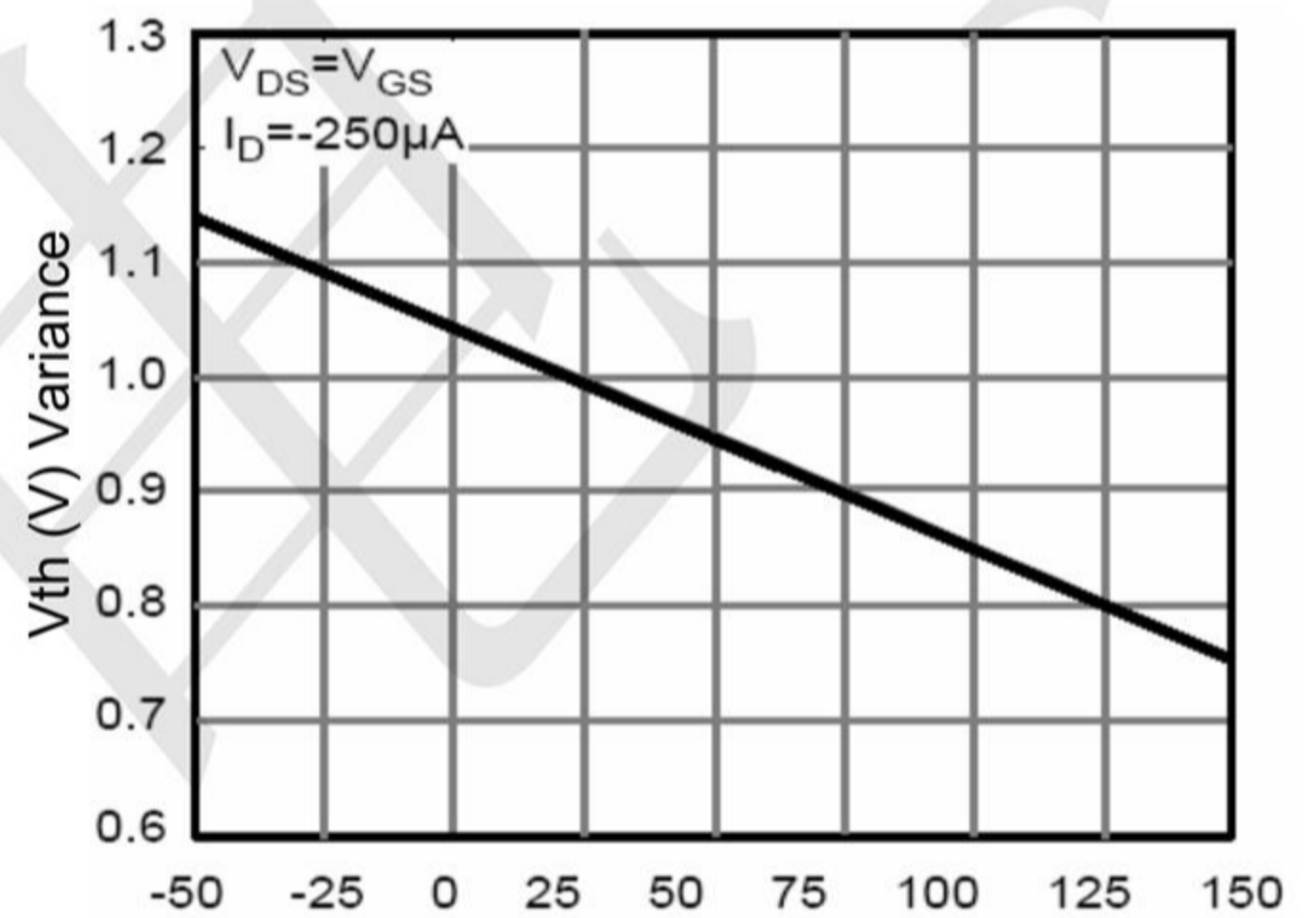
-Vds Drain-Source Voltage (V)  
Figure 7 Capacitance vs Vds



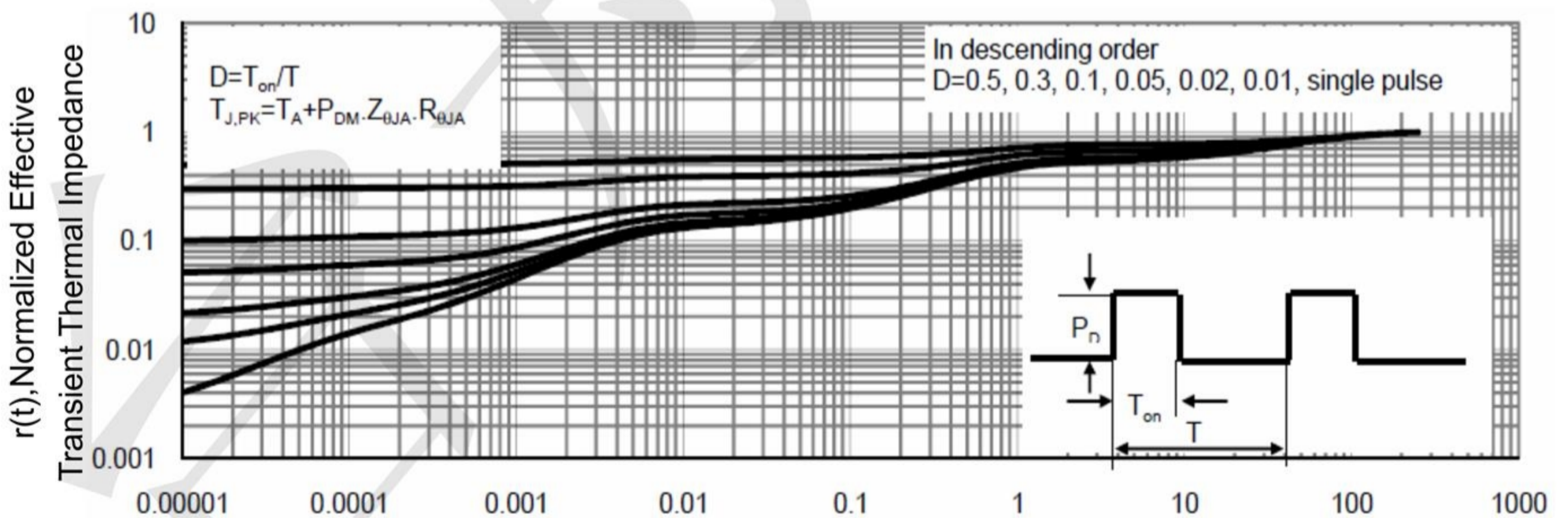
T<sub>J</sub>-Junction Temperature(°C)  
Figure 9 Power Dissipation



-Vds Drain-Source Voltage (V)  
Figure 8 Safe Operation Area



T<sub>J</sub>-Junction Temperature(°C)  
Figure 10 V<sub>GS(th)</sub> vs Junction Temperature



Square Wave Pulse Duration(sec)  
Figure 11 Normalized Maximum Transient Thermal Impedance





TECH PUBLIC

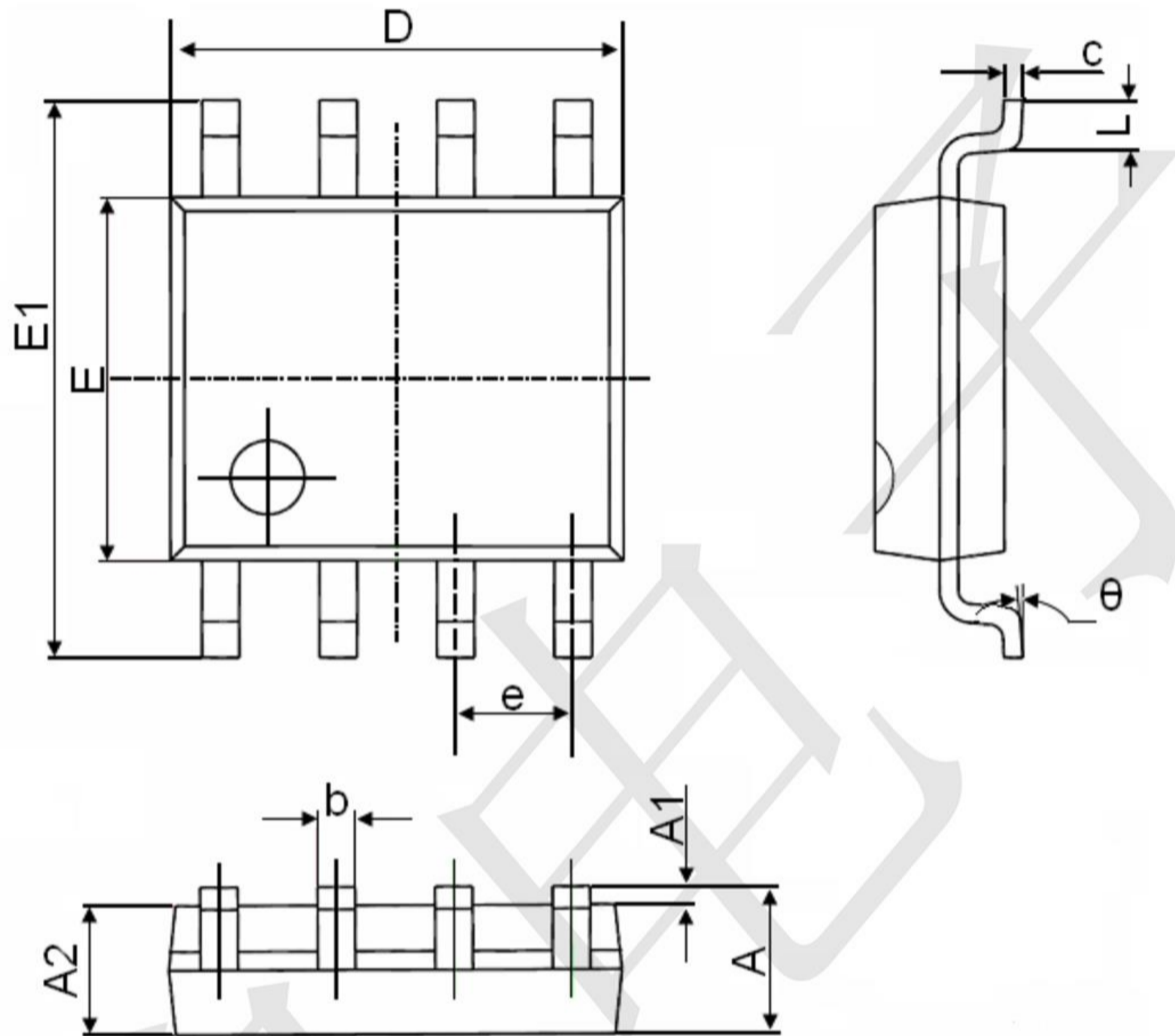
—台丹电子—

TPM40NP8S8

N and P-Channel Enhancement Mode Power MOSFET

www.sot23.com.tw

SOP-8 Package Information



Symbol	Dimensions In Millimeters		Dimensions In Inches	
	Min.	Max.	Min.	Max.
A	1.350	1.750	0.053	0.069
A1	0.100	0.250	0.004	0.010
A2	1.350	1.550	0.053	0.061
b	0.330	0.510	0.013	0.020
c	0.170	0.250	0.006	0.010
D	4.700	5.100	0.185	0.200
E	3.800	4.000	0.150	0.157
E1	5.800	6.200	0.228	0.244
e	1.270(BSC)		0.050(BSC)	
L	0.400	1.270	0.016	0.050
$\theta$	0°	8°	0°	8°