

SPECIFICATION FOR APPROVAL

承 認 書

Description : Piezo Siren

Kingstate Part No. : KPEG1501

Customer's Model No. : _____

Specification No. : PKD-7462

Number Of The Edition : 1.3

CUSTOMER'S APPROVED SIGNATURE		

 **KINGSTATE** 志豐電子股份有限公司 **KINGSTATE ELECTRONICS CORP.**

Address: 10F, No. 69-11, Sec. 2, Chung Cheng E. Rd., Tamshui County, Taipei Hsien, Taiwan, R.O.C.

International sales dept.: TEL:886-2-2809-5651 FAX:886-2-2809-7151

Domestic sales dept.: TEL:886-2-2809-0668 FAX:886-2-28096748

<http://www.kingstate.com.tw>

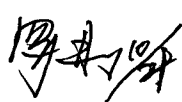
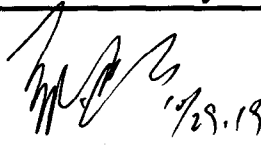
Approved by	Checked by	Issued by
	 10/29/19	陽志明 2019.10.29

KINGSTATE ELECTRONICS CORPORATION

志豐電子股份有限公司

修訂記錄

圖號: PKD-7462			料號: KPEG1501
修訂日期	提出者	版次	修訂記錄內容
2011/11/04	蔣娜娜	1.2	依工程 ER015-2011-10-14-140 執行包裝規格變更
2019.10.29	張建合	1.3	增加週期

A. SCOPE 範疇

This specification applies piezo audio siren, **KPEG1501**

此規格書適用於壓電式蜂鳴器, **KPEG1501**

B. SPECIFICATION 規格

No.	Item	Unit	Specification	Condition
1	Operating Frequency 操作頻率	KHz	2~3.5	
2	Operating Volt. range 操作電壓範圍	VDC	6~14	
3	Current consumption 消耗電流	mA	MAX. 70 Typical 50	at 12VDC
4	Sound pressure level 輸出音壓	dB	102	at 30 cm/12VDC(MIN.)
5	Rated Voltage 額定電壓	VDC	12	
6	Tone 聲音		Siren 警報音	
7	Operating temp. 操作溫度	°C	-10 ~ +60	10 minutes
8	Storage temp. 儲存溫度	°C	-40 ~ +80	
9	Dimension 尺寸	mm	L47.0 x W39.0 x H22.8	See appearance drawing 請參照外觀尺寸圖
10	Weight (MAX) 重量	gram	27.0	
11	Material 材質		ABS UL-94 1/16"HB HIGH HEAT (BLACK)	
12	Terminal 端子		Wire type	See appearance drawing 請參照外觀尺寸圖
13	Environmental Protection Regulation 環保法規		RoHS2.0	

C. APPEARANCE DRAWING 外觀尺寸圖

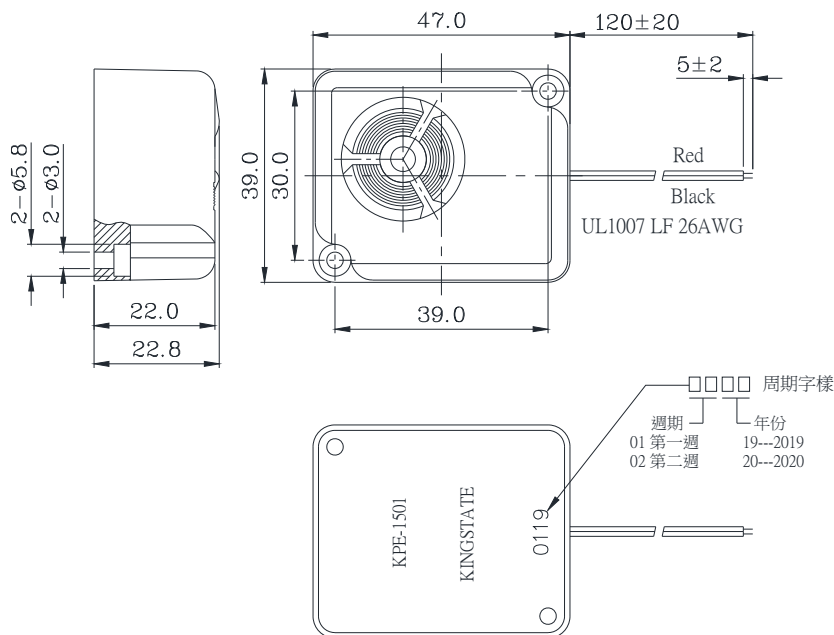

Tol : ± 0.5 Unit: mm

D. MEASURING METHOD 測量方法

S.P.L. Measuring Circuit 音壓測試接線圖

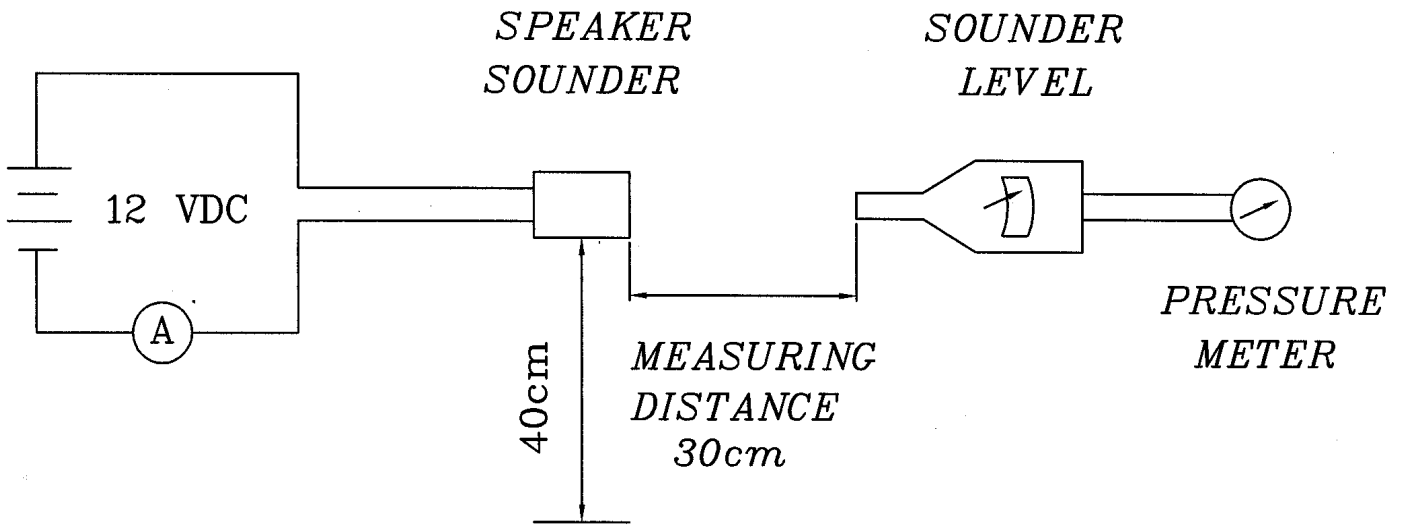

Mic: RION S.P.L. meter UC30 or equivalent

Mic: RION 噪音計 UC30 或同等品

E. VOLTAGE: SOUND PRESSURE LEVEL / VOLTAGE: CURRENT CONSUMPTION CHARACTERISTICS 電壓與音壓/電壓與耗電流之特性

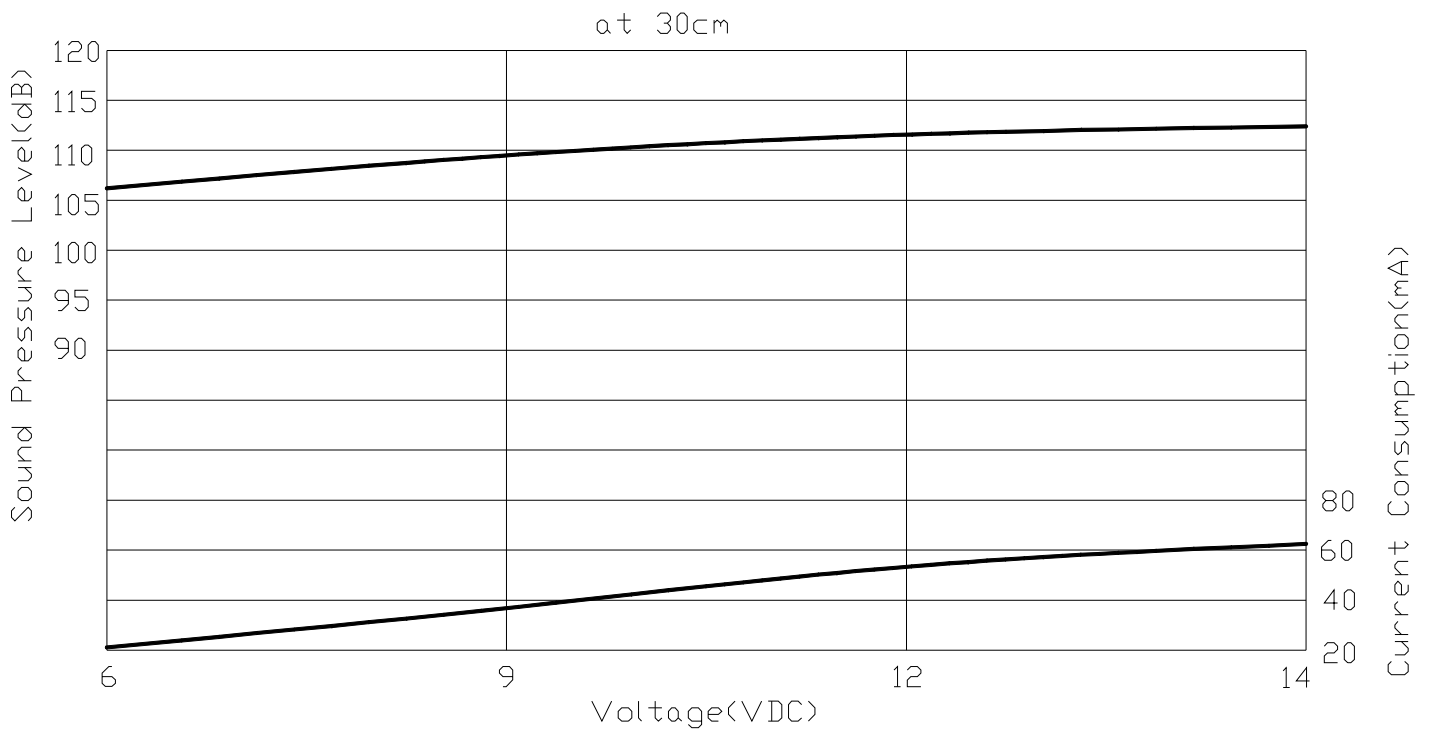

F. MECHANICAL CHARACTERISTICS 機械特性

No.	Item	Test Condition	Evaluation standard
1	Solderability 焊錫附着性 (Connector excepted) (端子類不適用此項)	Stripped wires of lead wires are immersed in rosin for 5 seconds and then immersed in solder bath of $+270\pm 5^{\circ}\text{C}$ for 3 ± 0.5 seconds. 裸線部份浸入松香溶液 5 秒後,再浸入 $+270\pm 5^{\circ}\text{C}$ 溶融焊錫槽 3 ± 0.5 秒.	90% min. stripped wires shall be wet with solder.(Except the edge of terminal) 浸入裸線部份附着焊錫 90%以上.(末端斷面不算)
2	Lead Wire Pull Strength 線材拉力	The pull force shall be applied to double lead wire : Horizontal 3.0N(0.306kg) for 30 seconds. Vertical 2.0N(0.204kg) for 30 seconds. 雙線材水平方向施以 3.0N(0.306kg)的力量, 垂直方向施以 2.0N(0.204kg) 的力量,各 30 秒.	No damage and cutting off. 線材不鬆動,不脫落.
3	Vibration 振動試驗	Buzzer shall be measured after being applied vibration of amplitude of 1.5mm with 10 to 55hz band of vibration frequency to each of 3 per-pendicular directions for 2 hours. 振動週波數 10~55HZ、全振幅 1.5mm 於 X.Y.Z 3 個方向,各 2 小時.	The value of oscillation frequency/ current consumption should be in $\pm 10\%$ compared with initial ones .The SPL should be in $\pm 10\text{dB}$ compared with initial one.
4	Drop test 落下測試	The part only shall be dropped from a height of 75cm onto a 40mm thick wooden board 3 times in 3 axes (X.Y.Z). (a total of 9 times). 單體從 75 公分高處, X.Y.Z.3 個方向,各 3 回,落於 40mm 厚木板上.	諧振頻率與消耗電流變化量須在 $\pm 10\%$ 內. 輸出音壓變化量須在 $\pm 10\text{dB}$ 內.

G. ENVIRONMENT TEST 環境測試

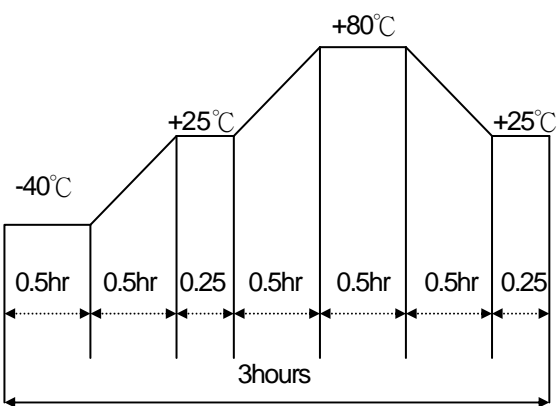
No.	Item	Test Condition	Evaluation standard
1	High temp. test 高溫測試	After being placed in a chamber at $+ 80^{\circ}\text{C}$ for 240 hours 置於 $+ 80^{\circ}\text{C}$ 環境中 240 小時	Being placed for 4 hours at $+25^{\circ}\text{C}$, buzzer shall be measured. The value of oscillation frequency/ current consumption should be in $\pm 10\%$ compared with initial ones. The SPL should be in $\pm 10\text{dB}$ compared with initial one. 經測試後, 靜置於 $+25^{\circ}\text{C}$ (室溫) 環境中 4 小時後,諧振頻率與消耗電流變化量須在 $\pm 10\%$ 內. 輸出音壓變化量須在 $\pm 10\text{dB}$ 內.
2	Low temp. test 低溫測試	After being placed in a chamber at -40°C for 240 hours 置於 -40°C 環境中 240 小時	
3	Humidity test 相對濕度測試	After being placed in a chamber at $+40^{\circ}\text{C}$ and $90\pm 5\%$ relative humidity for 240 hours 置於 $+40^{\circ}\text{C}$, 相對濕度 $90\pm 5\%$ 環境中 240 小時	
4	Temp. cycle test 溫度循環試驗	The part shall be subjected to 5 cycles. One cycle shall be consist of: 單體承受溫度循環測試 5 次,其循環內容如圖示: 	

LIABILITY TEST 信賴性測試

Item	Test condition	Evaluation standard
1 Operating life test 壽命測試	1. Continuous life test 高溫壽命測試(連續) 10 minutes continuous operation at +45°C with rated voltage applied. 在+45°C環境下,以額定電壓連續操作 10 分鐘 2. Intermittent life test 室溫壽命測試(間歇) A duty cycle of 1 minute on, 0.5 minutes off, a minimum of 960 times at room temp. (+25±2°C) and rated voltage applied 在室溫下(+25±2°C), 以額定電壓操作, 通電 1 分鐘/斷電 0.5 分鐘, 測試 960 次循環。	Being placed for 4 hours at +25°C, buzzer shall be measured. The value of oscillation frequency/ current consumption should be in ±10% compared with initial ones. The SPL should be in ±10dB compared with initial one. 經測試後, 靜置於+25°C (室溫) 環境中 4 小時後, 諧振頻率與消耗電流變化量須在±10%內. 輸出音壓變化量須在±10dB 內。

TEST CONDITION.

Standard Test Condition 一般測試條件	:	a) Temperature : +5 ~ +35°C	b) Humidity : 45-85%	c) Pressure : 860-1060mbar
Judgement Test Condition 爭議時測試條件	:	a) 溫度 : +5 ~ +35°C	b) 濕度 : 45-85%	c) 氣壓 : 860-1060mbar
	:	a) Temperature : +25 ± 2°C	b) Humidity : 60-70%	c) Pressure : 860-1060mbar
	:	a) 溫度 : +25 ± 2°C	b) 濕度 : 60-70%	c) 氣壓 : 860-1060mbar

I. PACKING STANDARD 包裝規格

