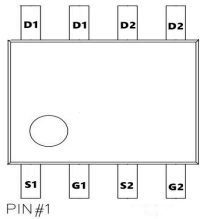
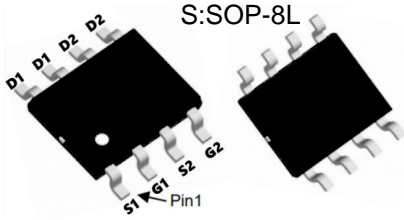
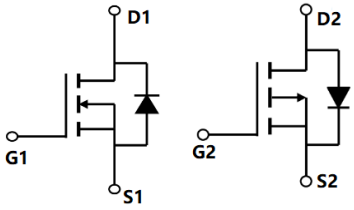

**TM08G04S**

**N+P-Channel Enhancement Mode Mosfet**

<p><b>General Description</b></p> <ul style="list-style-type: none"> <li>• Low <math>R_{DS(ON)}</math></li> <li>• RoHS and Halogen-Free Compliant</li> </ul> <p><b>Applications</b></p> <ul style="list-style-type: none"> <li>• Load switch</li> <li>• PWM</li> </ul>	<p><b>Product Summary</b></p> <p><b>N Channel</b>  <math>V_{DS} = 40V, I_D = 8A</math>  <math>R_{DS(ON)} = 24m\Omega</math> (typ.) @ <math>V_{GS} = 10V</math></p> <p><b>P Channel</b>  <math>V_{DS} = -40V, I_D = -7A</math>  <math>R_{DS(ON)} = 35m\Omega</math> (typ.) @ <math>V_{GS} = -10V</math></p> <p>100% UIS Tested                  100% <math>R_g</math> Tested</p> 
--	---

Marking: 08G04 OR 4614B

**Absolute Maximum Ratings ( $T_c = 25^\circ C$  unless otherwise noted)**

Symbol	Parameter	Rating		Units
		N-Ch	P-Ch	
$V_{DS}$	Drain-Source Voltage	40	-40	V
$V_{GS}$	Gate-Source Voltage	$\pm 20$	$\pm 20$	V
$I_D @ T_A = 25^\circ C$	Continuous Drain Current, $V_{GS} @ 10V^1$	8	-7	A
$I_D @ T_A = 70^\circ C$	Continuous Drain Current, $V_{GS} @ 10V^1$	4.2	-4.2	A
$I_{DM}$	Pulsed Drain Current <sup>2</sup>	26	-24	A
EAS	Single Pulse Avalanche Energy <sup>3</sup>	16.2	39	mJ
$P_D @ T_A = 25^\circ C$	Total Power Dissipation <sup>4</sup>	1.67	1.67	W
$T_{STG}$	Storage Temperature Range	-55 to 150	-55 to 150	$^\circ C$
$T_J$	Operating Junction Temperature Range	-55 to 150	-55 to 150	$^\circ C$
$R_{\theta JA}$	Thermal Resistance Junction-Ambient <sup>1</sup>	57		$^\circ C/W$
$R_{\theta JC}$	Thermal Resistance Junction-Case <sup>1</sup>	30		$^\circ C/W$

**TM08G04S**

**N+P-Channel Enhancement Mode Mosfet**

**N-Channel Electrical Characteristics (T<sub>J</sub>=25 °C, unless otherwise noted)**

Symbol	Parameter	Conditions	Min.	Typ.	Max.	Unit
BVDSS	Drain-Source Breakdown Voltage	V <sub>GS</sub> =0V, I <sub>D</sub> =250uA	40	44	---	V
ΔBVDSS/ΔT <sub>J</sub>	BVDSS Temperature Coefficient	Reference to 25°C, I <sub>D</sub> =1mA	---	0.034	---	V/°C
RDS(ON)	Static Drain-Source On-Resistance <sup>2</sup>	V <sub>GS</sub> =10V, I <sub>D</sub> =5A	---	24	35	mΩ
		V <sub>GS</sub> =4.5V, I <sub>D</sub> =4A	---	36	49	
VGS(th)	Gate Threshold Voltage	V <sub>GS</sub> =V <sub>DS</sub> , I <sub>D</sub> =250uA	1.5	2.5	3.5	V
ΔVGS(th)	VGS(th) Temperature Coefficient		---	-4.56	---	mV/°C
IDSS	Drain-Source Leakage Current	V <sub>DS</sub> =32V, V <sub>GS</sub> =0V, T <sub>J</sub> =25°C	---	---	1	uA
		V <sub>DS</sub> =32V, V <sub>GS</sub> =0V, T <sub>J</sub> =55°C	---	---	5	
IGSS	Gate-Source Leakage Current	V <sub>GS</sub> =±20V, V <sub>DS</sub> =0V	---	---	±100	nA
gfs	Forward Transconductance	V <sub>DS</sub> =5V, I <sub>D</sub> =5A	---	14	---	S
R <sub>g</sub>	Gate Resistance	V <sub>DS</sub> =0V, V <sub>GS</sub> =0V, f=1MHz	---	2.6	---	Ω
Q <sub>g</sub>	Total Gate Charge (4.5V)	V <sub>DS</sub> =20V, V <sub>GS</sub> =4.5V, I <sub>D</sub> =5A	---	5.5	---	nC
Q <sub>gs</sub>	Gate-Source Charge		---	1.25	---	
Q <sub>gd</sub>	Gate-Drain Charge		---	2.5	---	
Td(on)	Turn-On Delay Time	V <sub>DD</sub> =20V, V <sub>GS</sub> =10V, R <sub>G</sub> =3.3Ω I <sub>D</sub> =1A	---	8.9	---	ns
T <sub>r</sub>	Rise Time		---	2.2	---	
Td(off)	Turn-Off Delay Time		---	41	---	
T <sub>f</sub>	Fall Time		---	2.7	---	
C <sub>iss</sub>	Input Capacitance	V <sub>DS</sub> =15V, V <sub>GS</sub> =0V, f=1MHz	---	593	---	pF
C <sub>oss</sub>	Output Capacitance		---	76	---	
Crss	Reverse Transfer Capacitance		---	56	---	
I <sub>s</sub>	Continuous Source Current <sup>1,5</sup>	V <sub>G</sub> =V <sub>D</sub> =0V, Force Current	---	---	6.1	A
ISM	Pulsed Source Current <sup>2,5</sup>		---	---	23	A
VSD	Diode Forward Voltage <sup>2</sup>	V <sub>GS</sub> =0V, I <sub>S</sub> =1A, T <sub>J</sub> =25°C	---	---	1.2	V

**Note :**

- 1、 The data tested by surface mounted on a 1 inch<sup>2</sup> FR-4 board with 2OZ copper.
- 2、 The data tested by pulsed , pulse width ≅ 300us , duty cycle ≅ 2%
- 3、 The EAS data shows Max. rating . The test condition is V<sub>DD</sub>=25V,V<sub>GS</sub>=10V,L=0.1mH,I<sub>AS</sub>=10A
- 4、 The power dissipation is limited by 150°C junction temperature
- 5、 The data is theoretically the same as I<sub>D</sub> and I<sub>DM</sub> , in real applications , should be limited by total power dissipation.

**TM08G04S**

**N+P-Channel Enhancement Mode Mosfet**

**P-Channel Electrical Characteristics (T<sub>J</sub>=25 °C, unless otherwise noted)**

Symbol	Parameter	Conditions	Min.	Typ.	Max.	Unit
BVDSS	Drain-Source Breakdown Voltage	V <sub>GS</sub> =0V, I <sub>D</sub> =-250uA	-40	---	---	V
ΔBVDSS/ΔT <sub>J</sub>	BV <sub>DSS</sub> Temperature Coefficient	Reference to 25°C, I <sub>D</sub> =-1mA	---	-0.02	---	V/°C
RDS(ON)	Static Drain-Source On-Resistance <sup>2</sup>	V <sub>GS</sub> =-10V, I <sub>D</sub> =-5A	---	35	48	mΩ
		V <sub>GS</sub> =-4.5V, I <sub>D</sub> =-3A	---	49	68	
VGS(th)	Gate Threshold Voltage	V <sub>GS</sub> =V <sub>DS</sub> , I <sub>D</sub> =-250uA	-1.5	-2.5	-3.5	V
ΔVGS(th)	V <sub>GS(th)</sub> Temperature Coefficient		---	3.72	---	mV/°C
IDSS	Drain-Source Leakage Current	V <sub>DS</sub> =-32V, V <sub>GS</sub> =0V, T <sub>J</sub> =25°C	---	---	1	uA
		V <sub>DS</sub> =-32V, V <sub>GS</sub> =0V, T <sub>J</sub> =55°C	---	---	5	
IGSS	Gate-Source Leakage Current	V <sub>GS</sub> =±20V, V <sub>DS</sub> =0V	---	---	±100	nA
Q <sub>g</sub>	Total Gate Charge (-4.5V)	V <sub>DS</sub> =-20V, V <sub>GS</sub> =-4.5V, I <sub>D</sub> =-6A	---	15.8	---	nC
Q <sub>gs</sub>	Gate-Source Charge		---	3.5	---	
Q <sub>gd</sub>	Gate-Drain Charge		---	3.2	---	
Td(on)	Turn-On Delay Time	V <sub>DD</sub> =-15V, V <sub>GS</sub> =-10V, R <sub>G</sub> =3.3Ω, I <sub>D</sub> =-1A	---	5.2	---	ns
T <sub>r</sub>	Rise Time		---	7	---	
Td(off)	Turn-Off Delay Time		---	23	---	
T <sub>f</sub>	Fall Time		---	8	---	
C <sub>iss</sub>	Input Capacitance	V <sub>DS</sub> =-15V, V <sub>GS</sub> =0V, f=1MHz	---	1000	---	pF
C <sub>oss</sub>	Output Capacitance		---	160	---	
C <sub>rss</sub>	Reverse Transfer Capacitance		---	100	---	
I <sub>s</sub>	Continuous Source Current <sup>1,5</sup>	V <sub>G</sub> =V <sub>D</sub> =0V, Force Current	---	---	-5.7	A
VSD	Diode Forward Voltage <sup>2</sup>	V <sub>GS</sub> =0V, I <sub>s</sub> =-1A, T <sub>J</sub> =25°C	---	---	-1.2	V

**Note :**

- 1、 The data tested by surface mounted on a 1 inch<sup>2</sup> FR-4 board with 20Z copper.
- 2、 The data tested by pulsed, pulse width ≦ 300us, duty cycle ≦ 2%
- 3、 The EAS data shows Max. rating. The test condition is V<sup>DD</sup>=-25V, V<sup>GS</sup>=-10V, L=0.1mH, I<sup>AS</sup>=-7A
- 4、 The power dissipation is limited by 150°C junction temperature
- 5、 The data is theoretically the same as I<sub>D</sub> and I<sub>DM</sub>, in real applications, should be limited by total power dissipation.



TM08G04S

N+P-Channel Enhancement Mode Mosfet

N-Channel Typical Characteristics

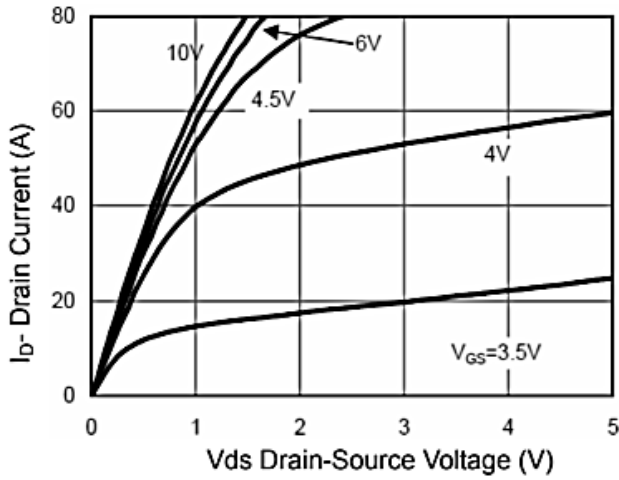

Figure 1 Output Characteristics

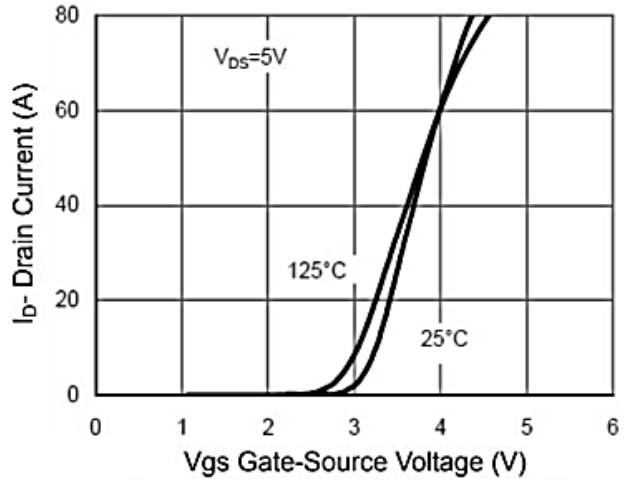

Figure 2 Transfer Characteristics

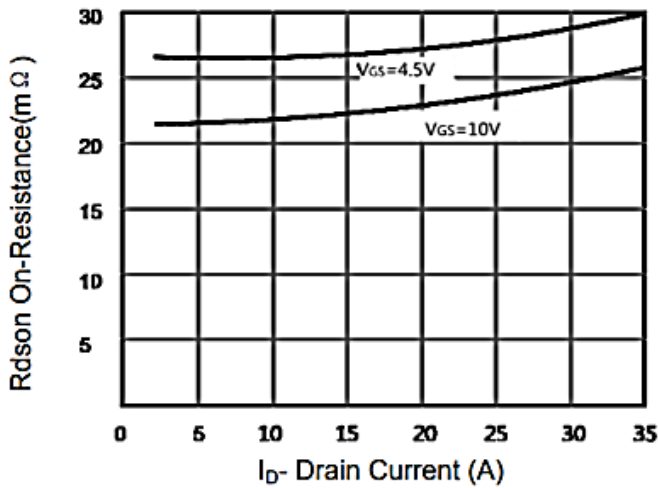

Figure 3 Rdson- Drain Current

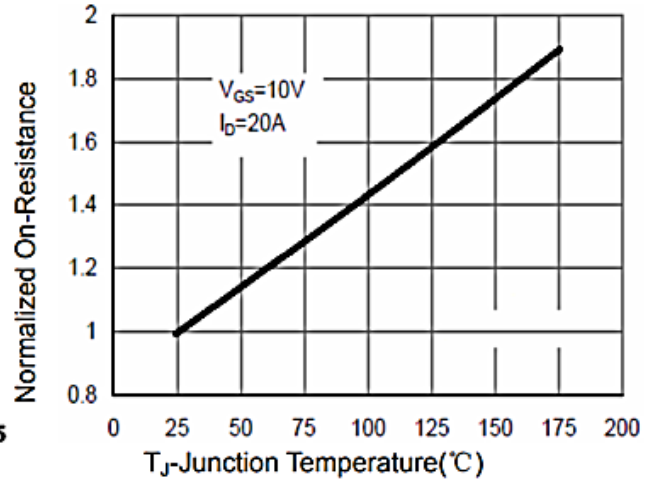

Figure 4 Rdson-Junction Temperature

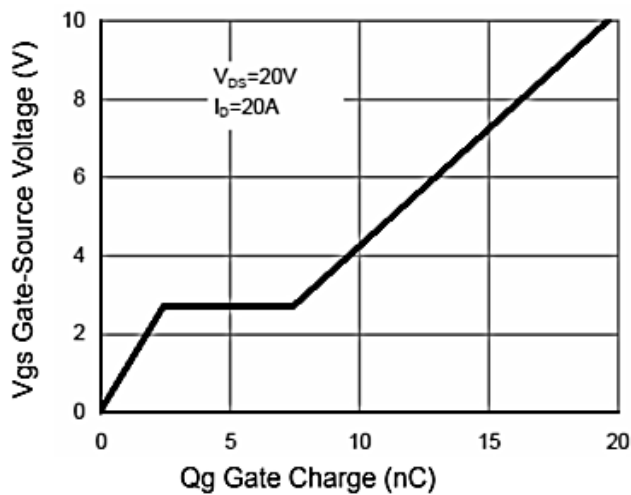

Figure 5 Gate Charge

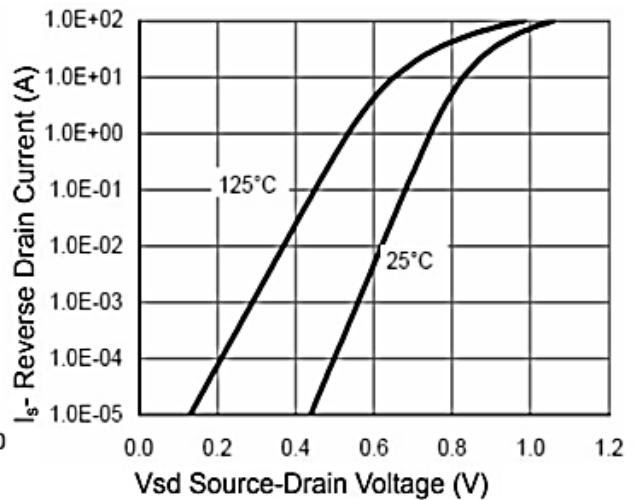

Figure 6 Source- Drain Diode Forward



TM08G04S

N+P-Channel Enhancement Mode Mosfet

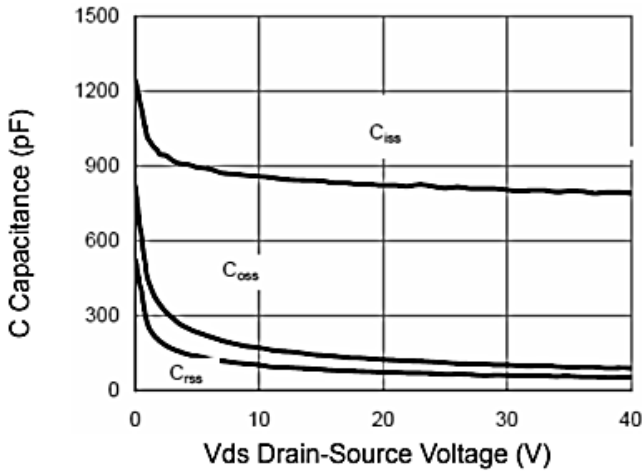

Figure 7 Capacitance vs Vds

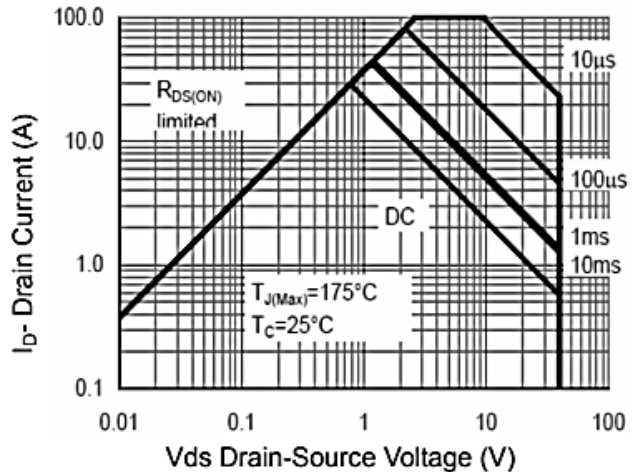

Figure 8 Safe Operation Area

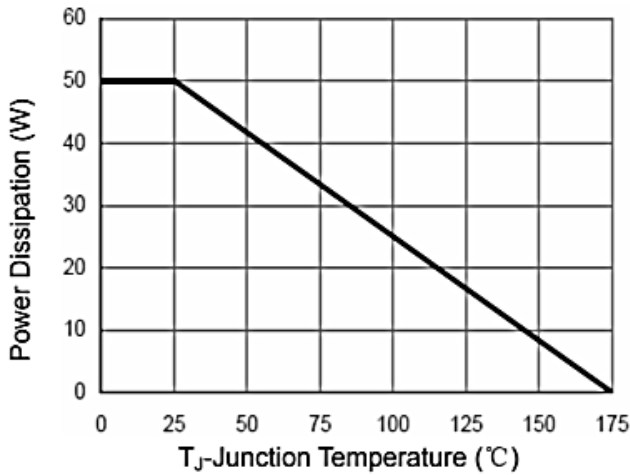

Figure 9 Power De-rating

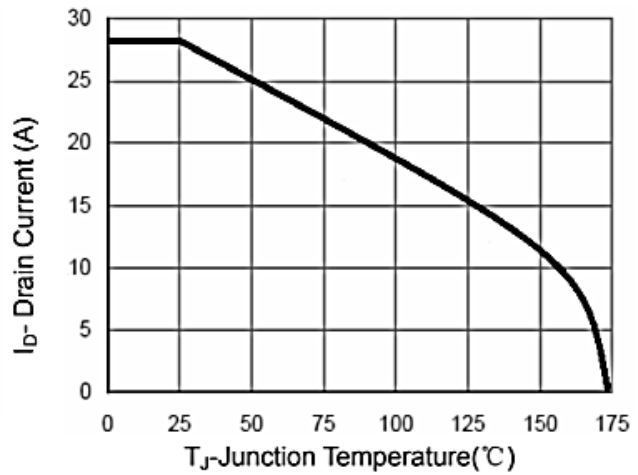

Figure 10 Id Current De-rating

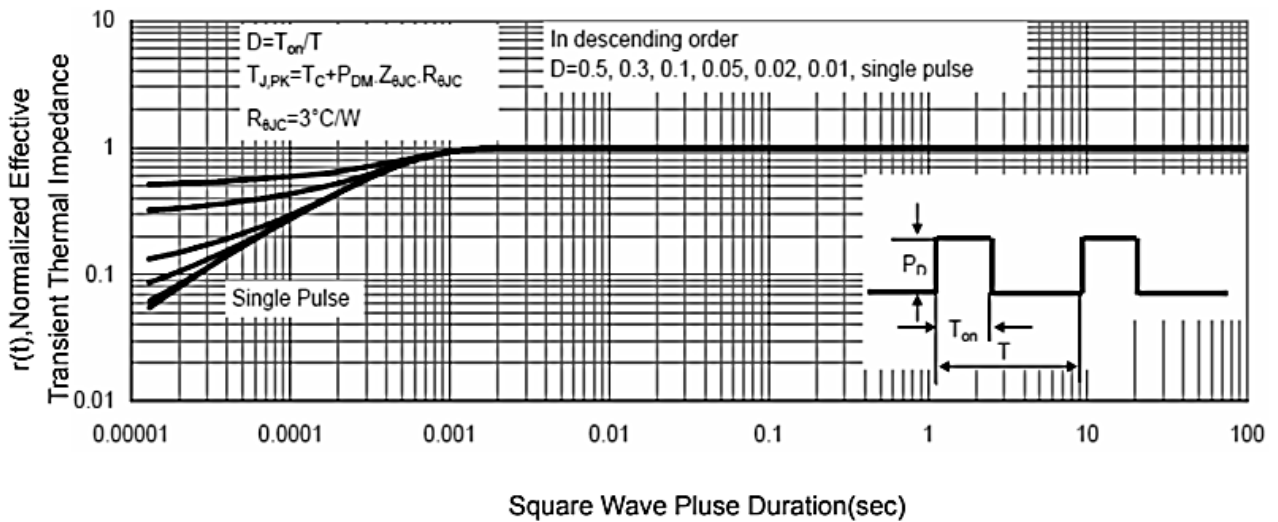

Figure 11 Normalized Maximum Transient Thermal Impedance



**TM08G04S**

**N+P-Channel Enhancement Mode Mosfet**

**P-Channel Typical Characteristics**

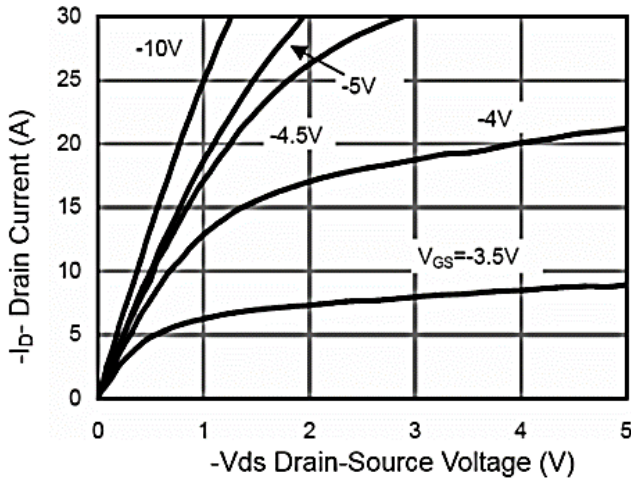

**Figure 1 Output Characteristics**

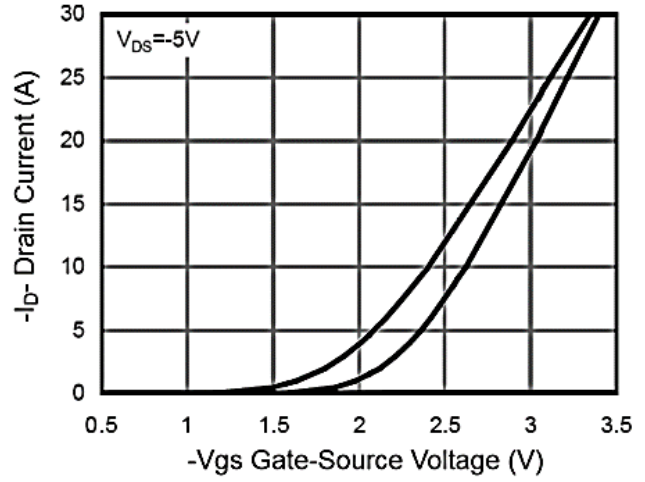

**Figure 2 Transfer Characteristics**

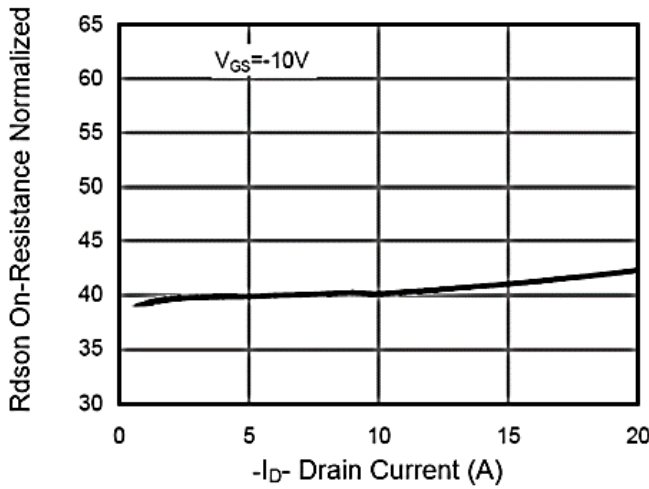

**Figure 3 Rdson- Drain Current**

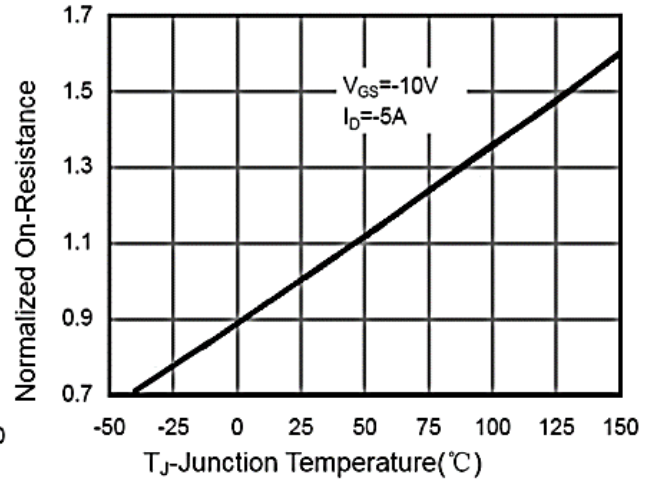

**Figure 4 Rdson-Junction Temperature**

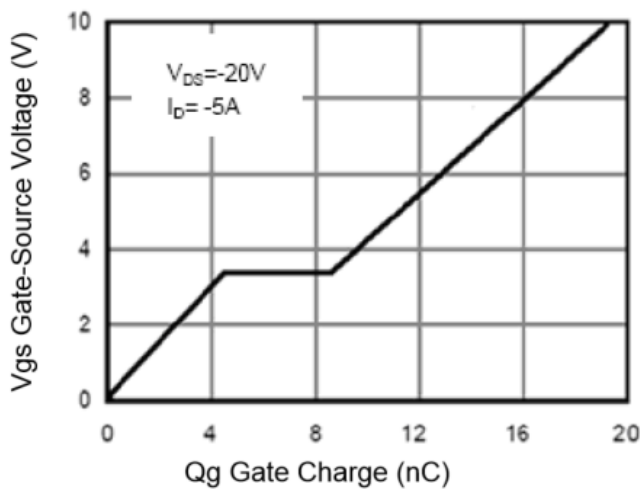

**Figure 5 Gate Charge**

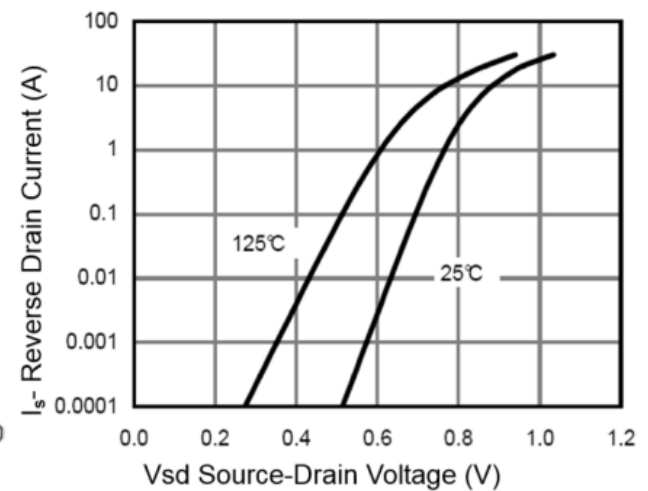

**Figure 6 Source- Drain Diode Forward**

TM08G04S

N+P-Channel Enhancement Mode Mosfet

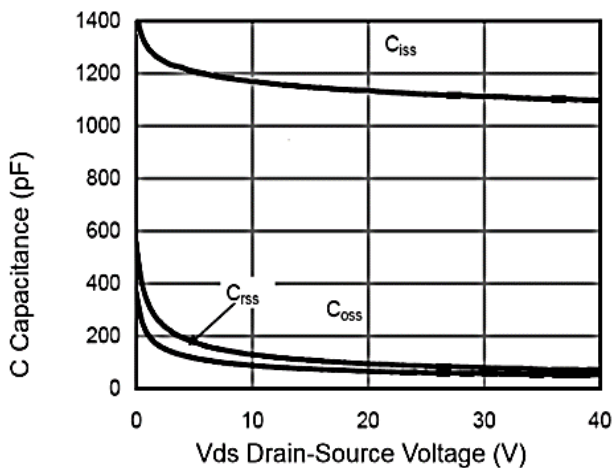

Figure 7 Capacitance vs Vds

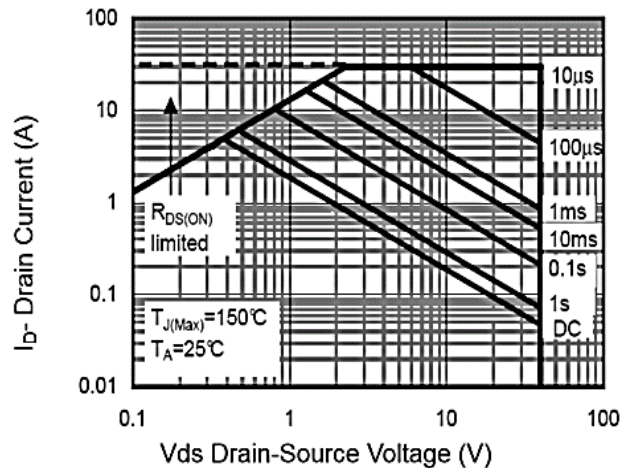

Figure 8 Safe Operation Area

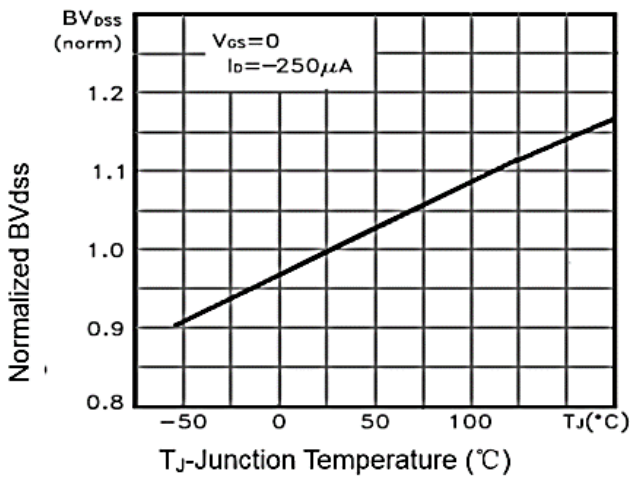

Figure 9  $BV_{DSS}$  vs Junction Temperature

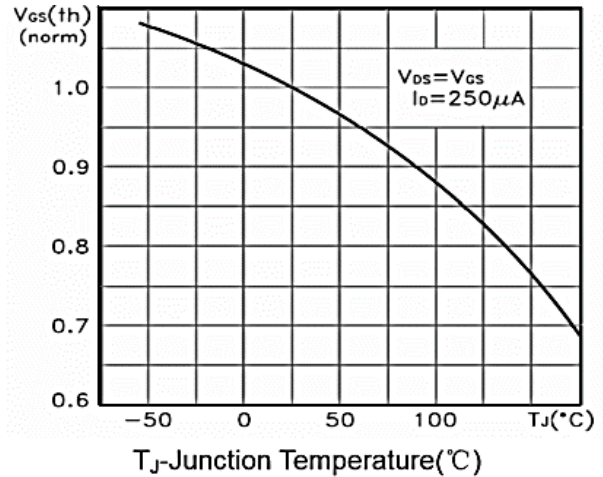

Figure 10  $V_{GS(th)}$  vs Junction Temperature

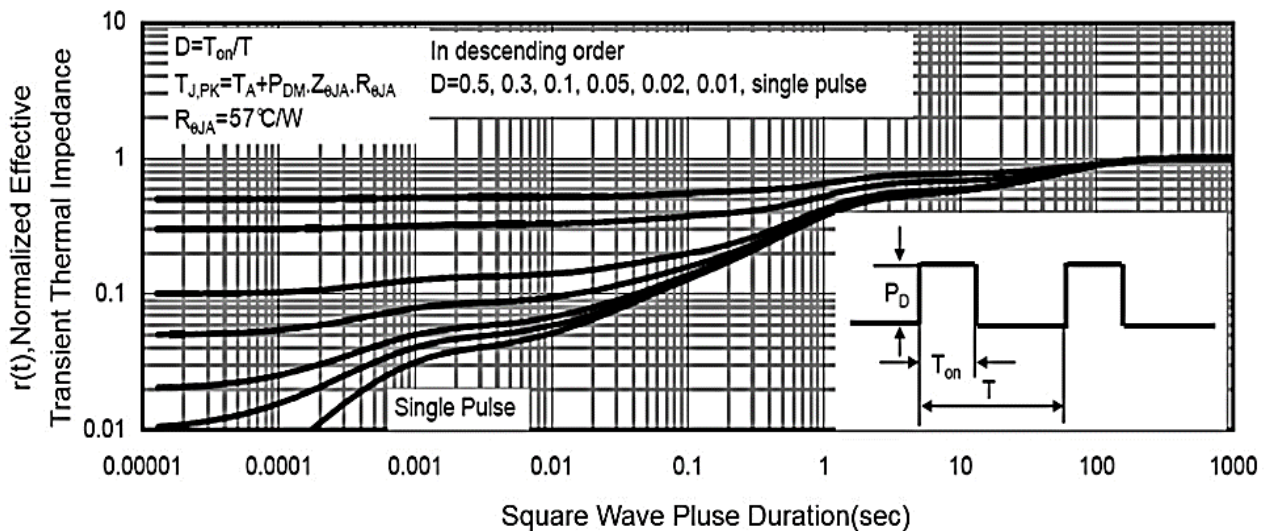
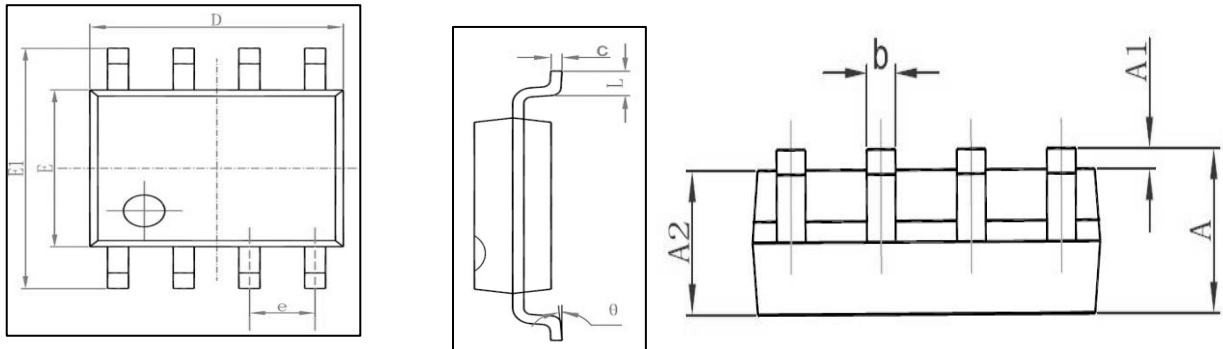
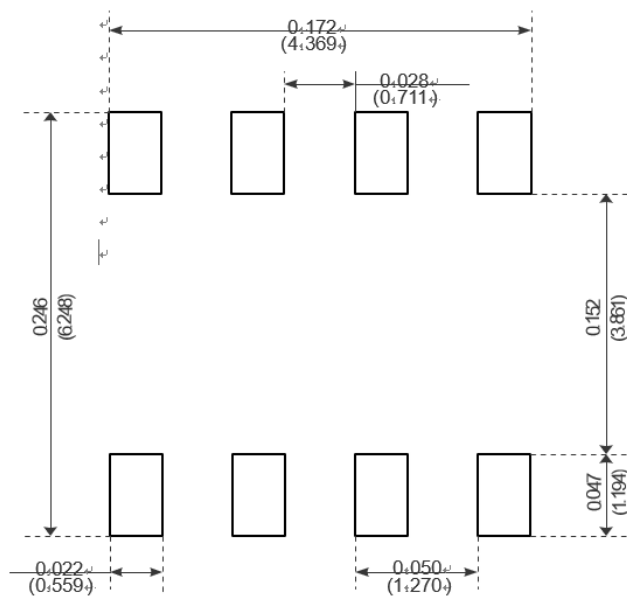

Figure 11 Normalized Maximum Transient Thermal Impedance

## Package Mechanical Data:SOP-8L



Symbol	Dimensions In Millimeters		Dimensions In Inches	
	Min	Max	Min	Max
A	1.350	1.750	0.053	0.069
A1	0.100	0.250	0.004	0.010
A2	1.350	1.550	0.053	0.061
b	0.330	0.510	0.013	0.020
c	0.170	0.250	0.006	0.010
D	4.700	5.100	0.185	0.200
E	3.800	4.000	0.150	0.157
E1	5.800	6.200	0.228	0.244
e	1.270 (BSC)		0.050 (BSC)	
L	0.400	1.270	0.016	0.050
θ	0°	8°	0°	8°



Recommended Minimum Pads