

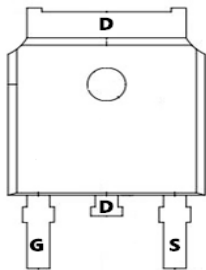

TM60N02AD

N-Channel Enhancement Mosfet

<p>General Description</p> <ul style="list-style-type: none"> • Low R_{DS(ON)} • RoHS and Halogen-Free Compliant <p>Applications</p> <ul style="list-style-type: none"> • Load switch • PWM 	<p>General Features</p> <p>V_{DS} =20V I_D = 58A</p> <p>R_{DS(ON)}=4.9mΩ(typ.)@V_{GS}=10V</p> <p>100% UIS Tested 100% R_g Tested</p> 
---	---



Marking: 60N02

D:TO-252-3L

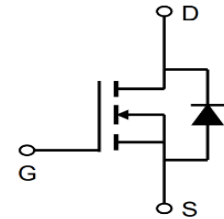
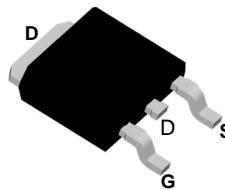

Absolute Maximum Ratings (T_C=25°C unless otherwise noted)

Symbol	Parameter	Rating	Unit	
Common Ratings				
V _{DSS}	Drain-Source Voltage	20	V	
V _{GSS}	Gate-Source Voltage	±12		
T _J	Maximum Junction Temperature	150	°C	
T _{STG}	Storage Temperature Range	-55 to 150	°C	
I _S	Diode Continuous Forward Current	T _C =25°C	20	A
I _D	Continuous Drain Current	T _C =25°C	60*	A
		T _C =100°C	70	
I _{DM} ^a	Pulse Drain Current Tested	T _C =25°C	260	A
P _D	Maximum Power Dissipation	T _C =25°C	50	W
		T _C =100°C	20	
R _{θJC}	Thermal Resistance-Junction to Case	Steady State	2.5	°C/W
I _D	Continuous Drain Current	T _A =25°C	18	A
		T _A =70°C	15	
P _D	Maximum Power Dissipation	T _A =25°C	2.5	W
		T _A =70°C	1.6	
R _{θJA}	Thermal Resistance-Junction to Ambient	t ≤ 10s	20	°C/W
		Steady State	50	
I _{AS} ^b	Avalanche Current, Single pulse	L=0.5mH	19	A
E _{AS} ^b	Avalanche Energy, Single pulse	L=0.5mH	212	mJ

Note a : *Current is limited by bond wire.

Note b : UIS tested and pulse width are limited by maximum junction temperature 150°C (initial temperature T_J=25°C).



TM60N02AD

N-Channel Enhancement Mosfet

Electrical Characteristics ($T_A = 25^\circ\text{C}$ Unless Otherwise Noted)

Symbol	Parameter	Test Conditions	Min.	Typ.	Max.	Unit
Static Characteristics						
BV_{DSS}	Drain-Source Breakdown Voltage	$V_{GS}=0V, I_{DS}=250\mu A$	20	-	-	V
I_{DSS}	Zero Gate Voltage Drain Current	$V_{DS}=20V, V_{GS}=0V$ $T_J=85^\circ\text{C}$	-	-	1	μA
			-	-	30	
$V_{GS(th)}$	Gate Threshold Voltage	$V_{DS}=V_{GS}, I_{DS}=250\mu A$	0.5	0.75	1	V
I_{GSS}	Gate Leakage Current	$V_{GS}=\pm 12V, V_{DS}=0V$	-	-	± 100	nA
$R_{DS(ON)}^c$	Drain-Source On-state Resistance	$V_{GS}=10V, I_{DS}=60A$ $T_J=125^\circ\text{C}$	-	5.3	6.4	m Ω
			-	3.9	-	
			-	6.5	9	
		$V_{GS}=2.5V, I_{DS}=50A$	-	7.8	10	
Diode Characteristics						
V_{SD}^c	Diode Forward Voltage	$I_{SD}=10A, V_{GS}=0V$	-	0.7	1.1	V
t_{rr}	Reverse Recovery Time	$I_{DS}=20A, di_{SD}/dt=100A/\mu s$	-	16	-	ns
t_a	Charge Time		-	9.2	-	
t_b	Discharge Time		-	7	-	
Q_{rr}	Reverse Recovery Charge		-	7.5	-	
Dynamic Characteristics ^d						
R_G	Gate Resistance	$V_{GS}=0V, V_{DS}=0V, F=1\text{MHz}$	-	2.5	5	Ω
C_{iss}	Input Capacitance	$V_{GS}=0V,$ $V_{DS}=15V,$ Frequency=1.0MHz	-	2450	-	pF
C_{oss}	Output Capacitance		-	270	-	
C_{riss}	Reverse Transfer Capacitance		-	190	-	
$t_{d(ON)}$	Turn-on Delay Time	$V_{DD}=15V, R_L=15\Omega,$ $I_{DS}=1A, V_{GEN}=10V,$ $R_G=6\Omega$	-	13	-	ns
t_r	Turn-on Rise Time		-	11.6	-	
$t_{d(OFF)}$	Turn-off Delay Time		-	85	-	
t_f	Turn-off Fall Time		-	42	-	
Gate Charge Characteristics ^d						
Q_g	Total Gate Charge	$V_{DS}=15V, V_{GS}=4.5V,$ $I_{DS}=25A$	-	23	-	nC
Q_g	Total Gate Charge	$V_{DS}=15V, V_{GS}=10V,$ $I_{DS}=25A$	-	50	-	
Q_{gth}	Threshold Gate Charge		-	1.25	-	
Q_{gs}	Gate-Source Charge		-	2.8	-	
Q_{gd}	Gate-Drain Charge		-	8.2	-	

Note c : Pulse test ; pulse width $\leq 300\mu s$, duty cycle $\leq 2\%$.

Note d : Guaranteed by design, not subject to production testing.

Typical Operating Characteristics

Power Dissipation

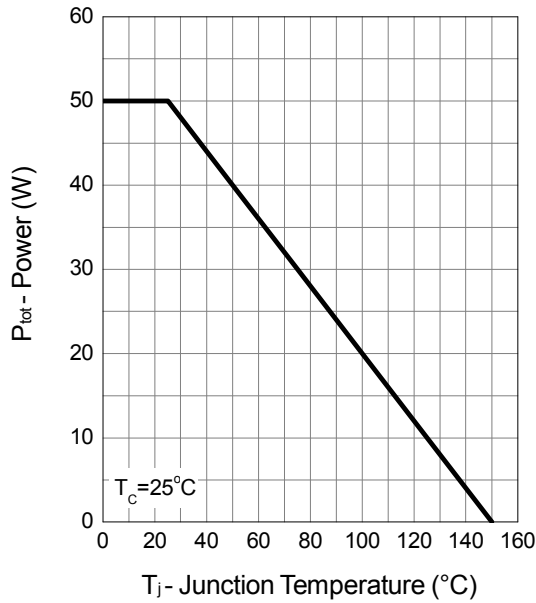

Drain Current

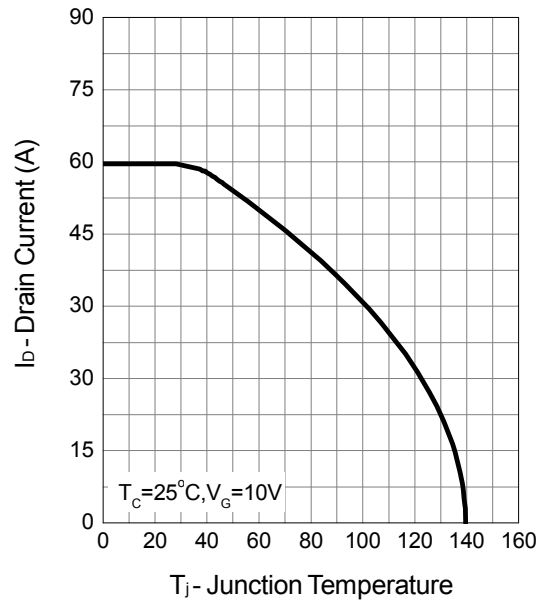

Safe Operation Area

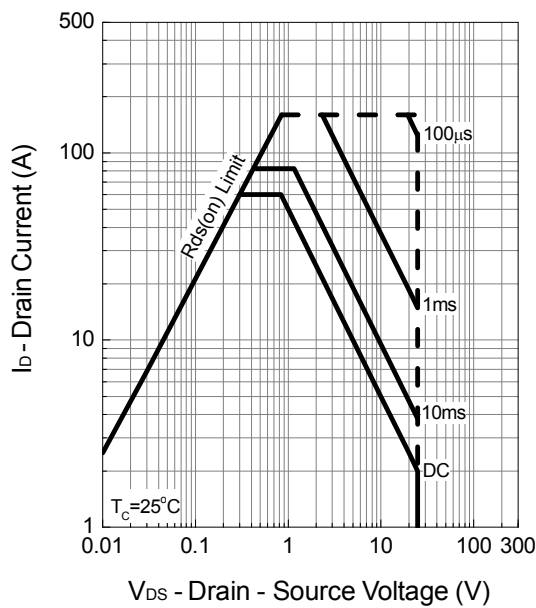

Thermal Transient Impedance

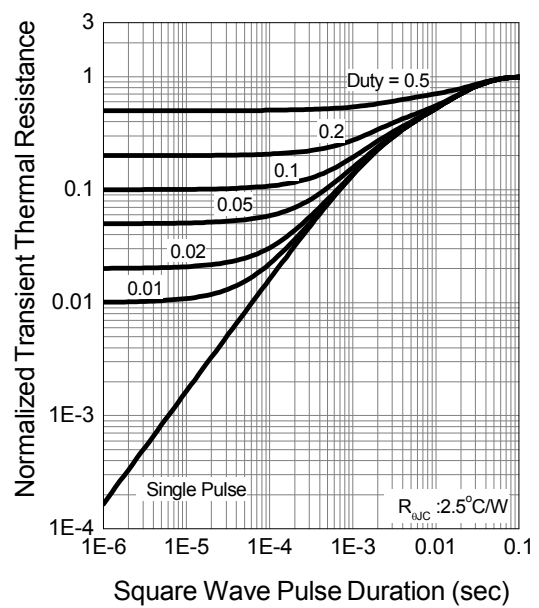



TM60N02AD

N-Channel Enhancement Mosfet

Output Characteristics

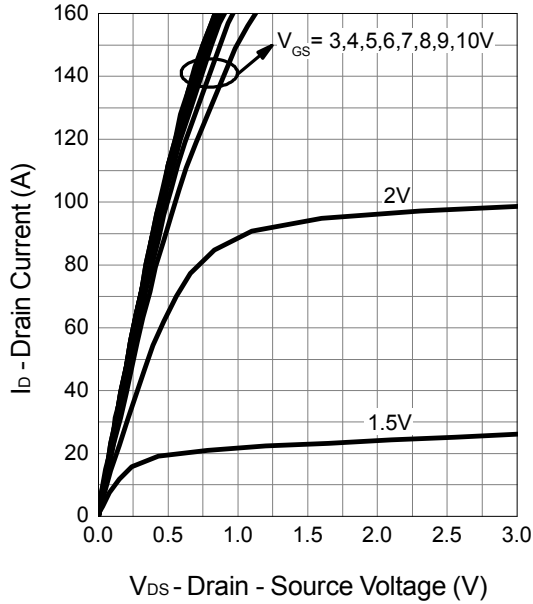

Drain-Source On Resistance

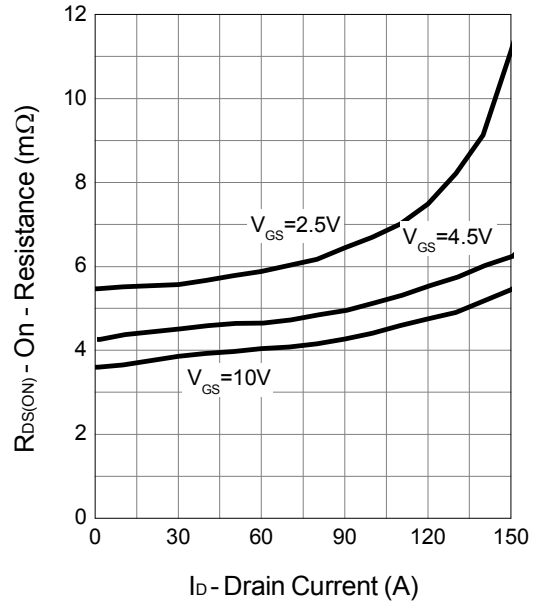

Gate-Source On Resistance

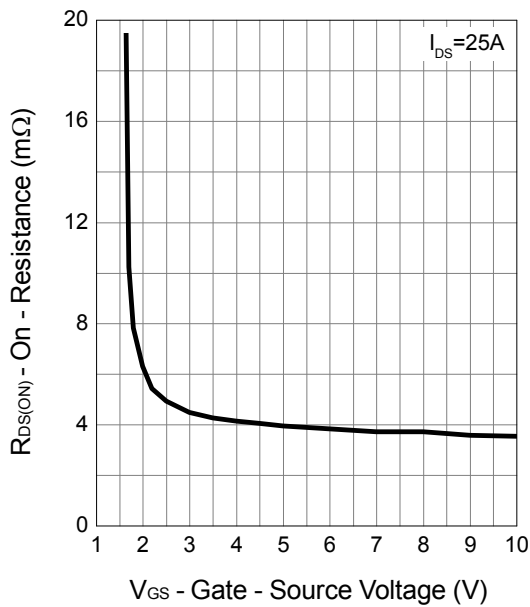

Gate Threshold Voltage

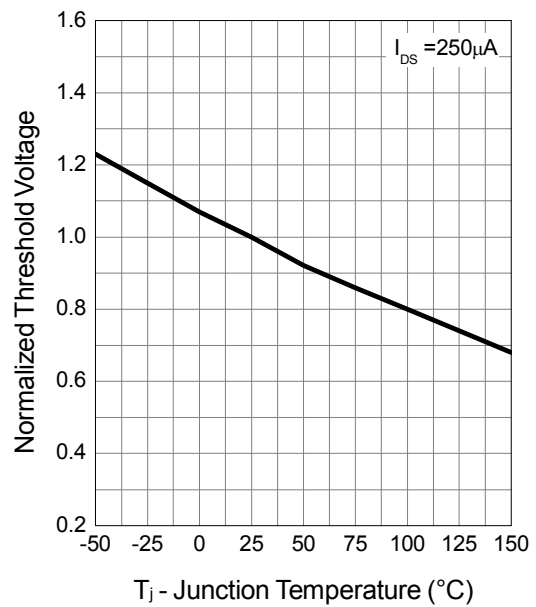



TM60N02AD

N-Channel Enhancement Mosfet

Drain-Source On Resistance

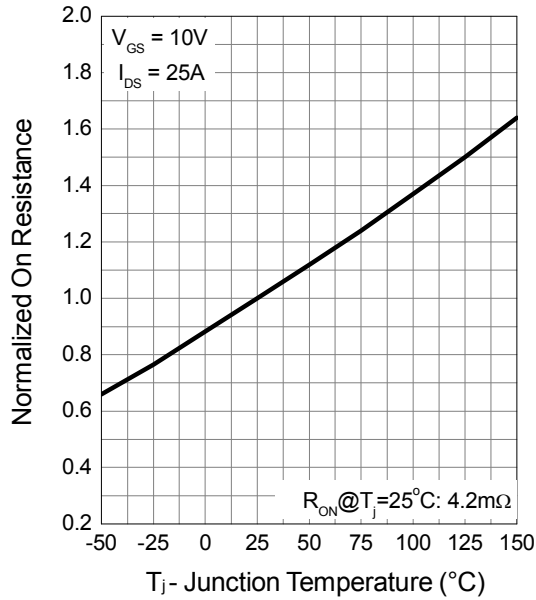

Source-Drain Diode Forward

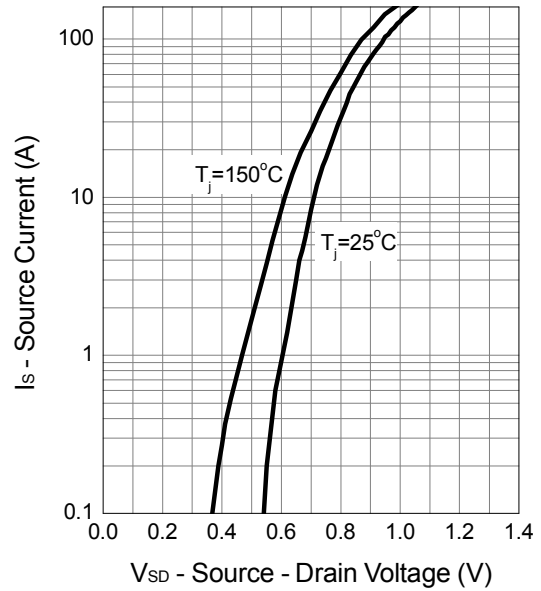

Capacitance

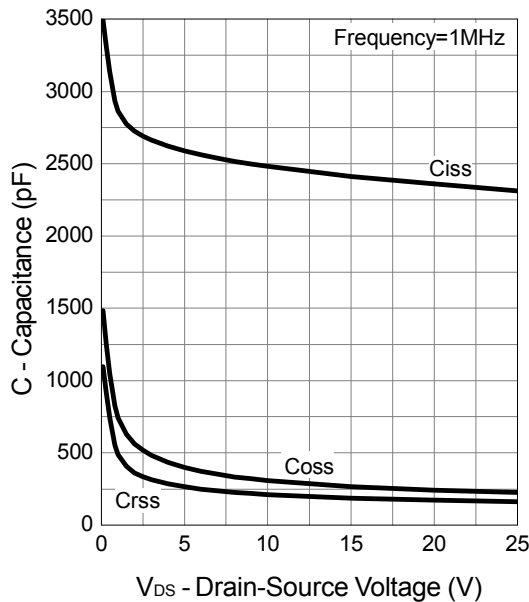

Gate Charge

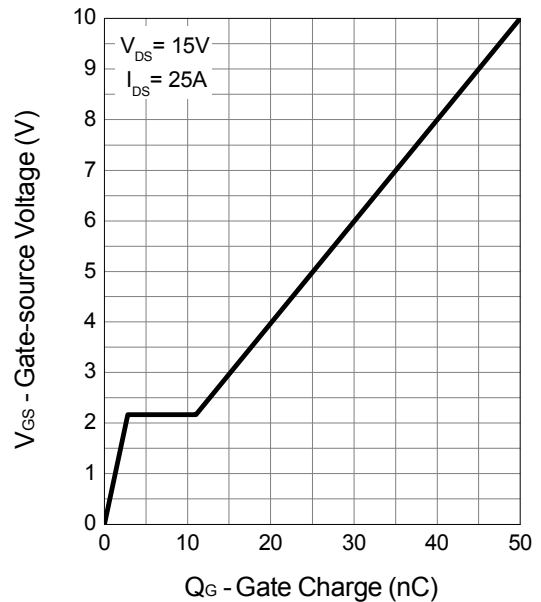

Avalanche Test Circuit and Waveforms

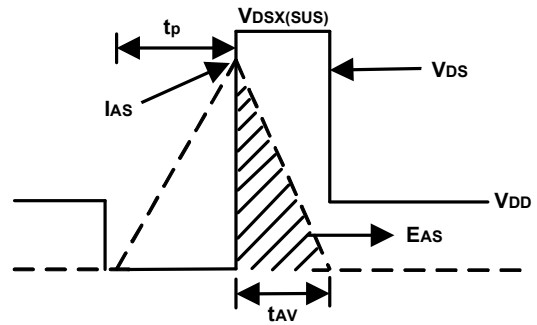
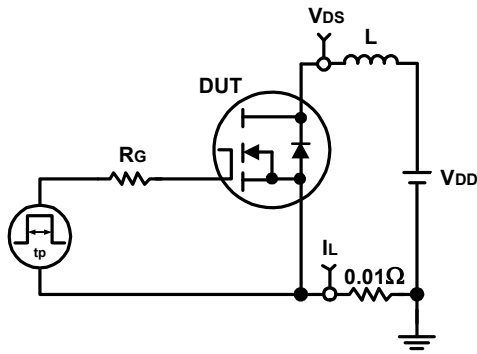

Switching Time Test Circuit and Waveforms

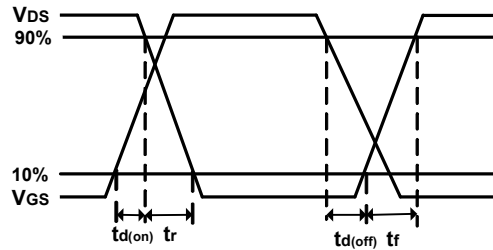
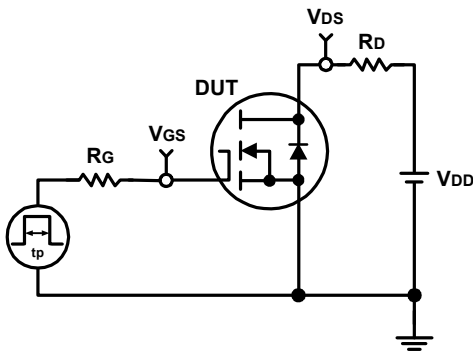

Package Information:TO-252-3L

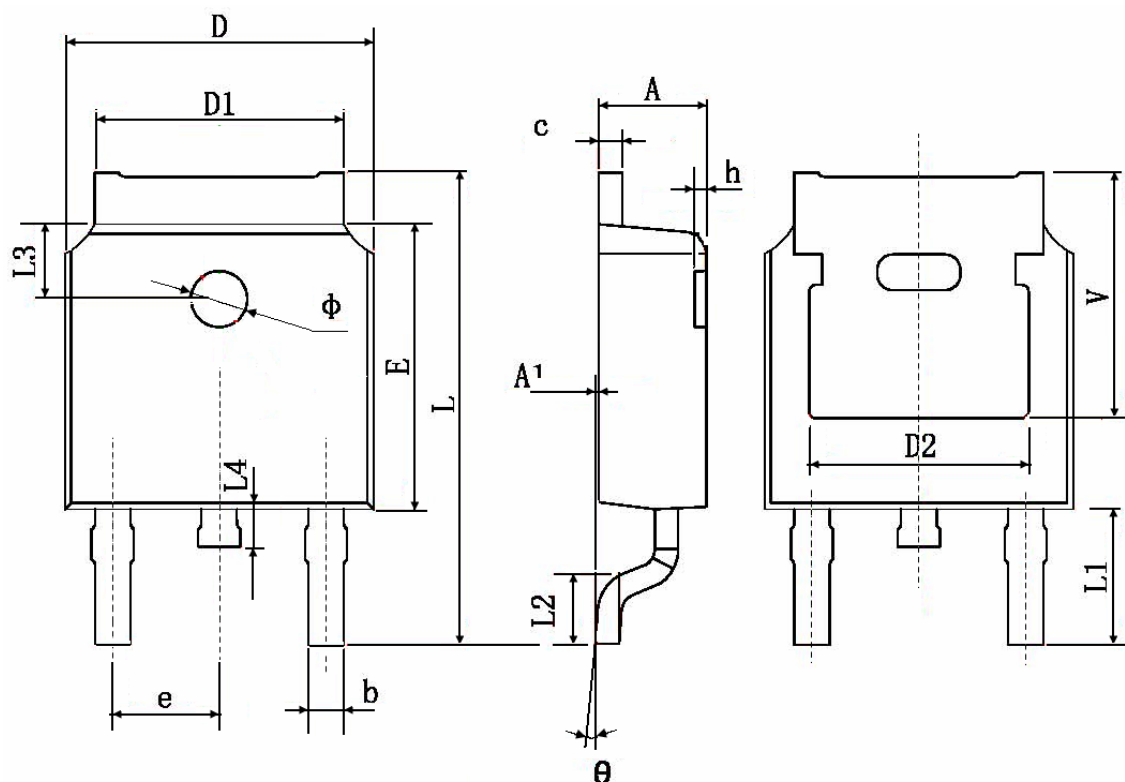

Symbol	Dimensions In Millimeters		Dimensions In Inches	
	Min.	Max.	Min.	Max.
A	2.200	2.400	0.087	0.094
A1	0.000	0.127	0.000	0.005
b	0.660	0.860	0.026	0.034
c	0.460	0.580	0.018	0.023
D	6.500	6.700	0.256	0.264
D1	5.100	5.460	0.201	0.215
D2	4.830 TYP.		0.190 TYP.	
E	6.000	6.200	0.236	0.244
e	2.186	2.386	0.086	0.094
L	9.800	10.400	0.386	0.409
L1	2.900 TYP.		0.114 TYP.	
L2	1.400	1.700	0.055	0.067
L3	1.600 TYP.		0.063 TYP.	
L4	0.600	1.000	0.024	0.039
φ	1.100	1.300	0.043	0.051
θ	0°	8°	0°	8°
h	0.000	0.300	0.000	0.012
V	5.350 TYP.		0.211 TYP.	