

TM55P03DF

P -Channel Enhancement Mosfet

<p>General Description</p> <ul style="list-style-type: none"> • Low $R_{DS(ON)}$ • RoHS and Halogen-Free Compliant <p>Applications</p> <ul style="list-style-type: none"> • Load switch • PWM 	<p>General Features</p> <p>$V_{DS} = -30V$ $I_D = -55A$</p> <p>$R_{DS(ON)} = 8.5m\Omega$ (typ.) @ $V_{GS} = -10V$</p> <p>100% UIS Tested 100% R_g Tested</p> 
--	---

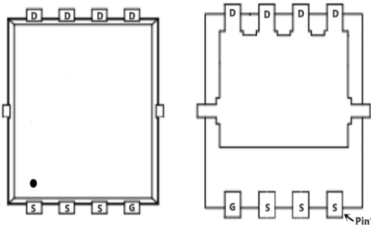

Marking: 55P03 OR 3419A

DF:DFN3x3_8L

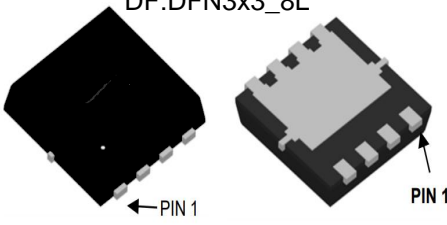

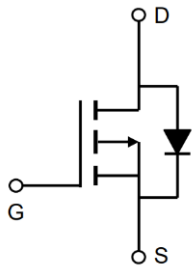

Absolute Maximum Ratings ($T_A = 25^\circ C$, unless otherwise noted)

Symbol	Parameter	Max.	Units
V_{DSS}	Drain-Source Voltage	-30	V
V_{GSS}	Gate-Source Voltage	± 20	V
I_D	Continuous Drain Current	$T_C = 25^\circ C$	-55
		$T_C = 100^\circ C$	-23
I_{DM}	Pulsed Drain Current ^{note1}	-140	A
E_{AS}	Single Pulsed Avalanche Energy ^{note2}	78.8	mJ
P_D	Power Dissipation	$T_C = 25^\circ C$	21.5
$R_{\theta JC}$	Thermal Resistance, Junction to Case	5.8	$^\circ C/W$
T_J, T_{STG}	Operating and Storage Temperature Range	-55 to +150	$^\circ C$

Electrical Characteristics ($T_J=25^{\circ}\text{C}$ unless otherwise specified)

Symbol	Parameter	Test Condition	Min.	Typ.	Max.	Units
Off Characteristic						
$V_{(BR)DSS}$	Drain-Source Breakdown Voltage	$V_{GS}=0V, I_D = -250\mu A$	-30	-	-	V
I_{DSS}	Zero Gate Voltage Drain Current	$V_{DS} = -30V, V_{GS} = 0V,$	-	-	-1	μA
I_{GSS}	Gate to Body Leakage Current	$V_{DS} = 0V, V_{GS} = \pm 20V$	-	-	± 100	nA
On Characteristics						
$V_{GS(th)}$	Gate Threshold Voltage	$V_{DS} = V_{GS}, I_D = -250\mu A$	-1.0	-1.5	-2.5	V
$R_{DS(on)}$	Static Drain-Source on-Resistance <small>note3</small>	$V_{GS} = -10V, I_D = -12A$	-	8.5	11	m Ω
		$V_{GS} = -4.5V, I_D = -8A$	-	13	18	
Dynamic Characteristics						
C_{iss}	Input Capacitance	$V_{DS} = -15V, V_{GS} = 0V,$ $f = 1.0MHz$	-	2800	-	pF
C_{oss}	Output Capacitance		-	346	-	pF
C_{rss}	Reverse Transfer Capacitance		-	319	-	pF
Q_g	Total Gate Charge	$V_{DS} = -15V, I_D = -20A,$ $V_{GS} = -10V$	-	30	-	nC
Q_{gs}	Gate-Source Charge		-	5.3	-	nC
Q_{gd}	Gate-Drain("Miller") Charge		-	7.6	-	nC
Switching Characteristics						
$t_{d(on)}$	Turn-on Delay Time	$V_{DD} = -15V, I_D = -20A,$ $V_{GS} = -10V, R_{GEN} = 2.5\Omega$	-	14	-	ns
t_r	Turn-on Rise Time		-	20	-	ns
$t_{d(off)}$	Turn-off Delay Time		-	95	-	ns
t_f	Turn-off Fall Time		-	65	-	ns
Drain-Source Diode Characteristics and Maximum Ratings						
I_S	Maximum Continuous Drain to Source Diode Forward Current		-	-	-55	A
I_{SM}	Maximum Pulsed Drain to Source Diode Forward Current		-	-	-140	A
V_{SD}	Drain to Source Diode Forward Voltage	$V_{GS} = 0V, I_S = -35A$	-	-0.8	-1.2	V

Notes:1. Repetitive Rating: Pulse Width Limited by Maximum Junction Temperature

 2. EAS condition: $T_J = 25^{\circ}\text{C}$, $V_{DD} = -20V$, $V_G = -10V$, $L = 0.5mH$, $R_G = 25\Omega$, $I_{AS} = -17A$

 3. Pulse Test: Pulse Width $\leq 300\mu s$, Duty Cycle $\leq 2\%$

Typical Performance Characteristics

Figure 1: Output Characteristics

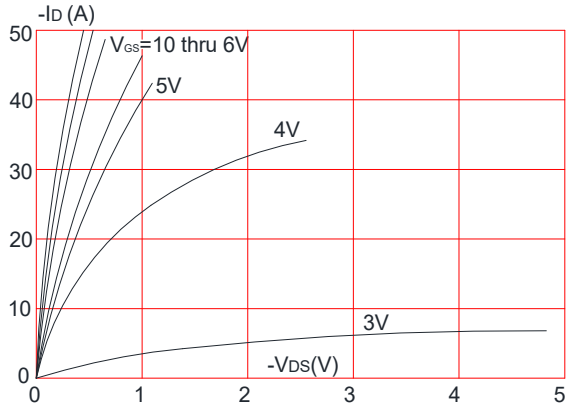

Figure 2: Typical Transfer Characteristics

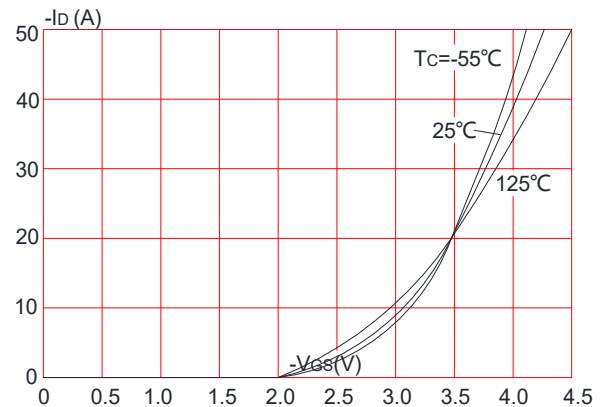

Figure 3: On-resistance vs. Drain Current

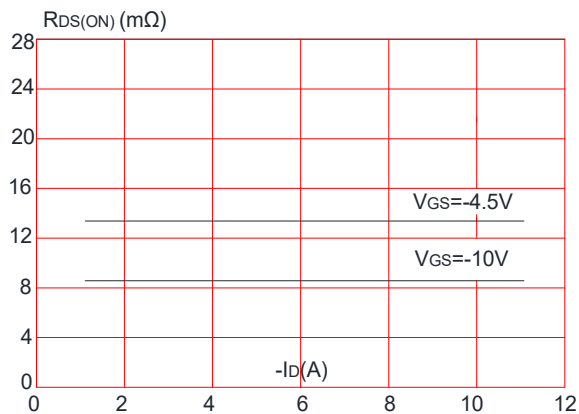

Figure 4: Body Diode Characteristics

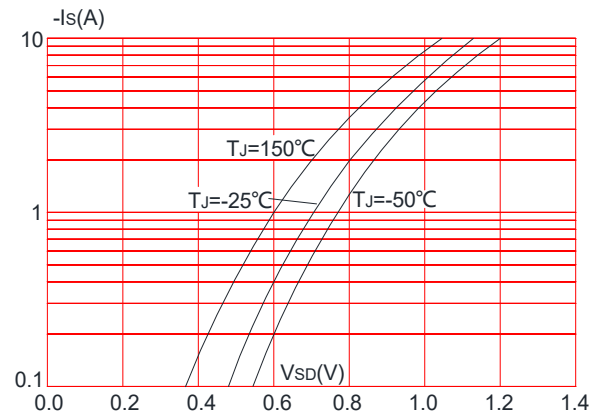

Figure 5: Gate Charge Characteristics

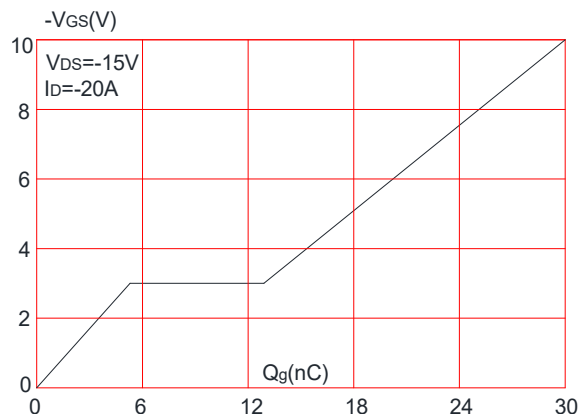

Figure 6: Capacitance Characteristics

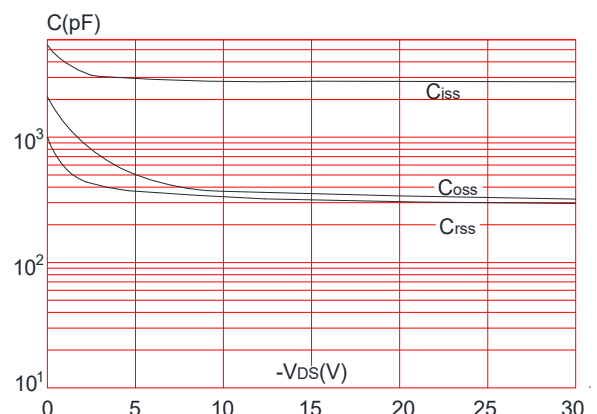

Figure 7: Normalized Breakdown Voltage vs. Junction Temperature

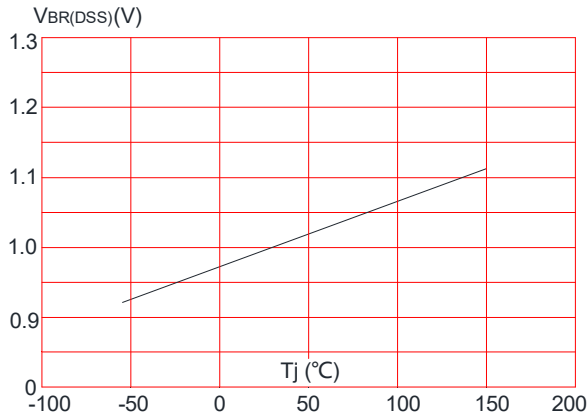

Figure 8: Normalized on Resistance vs. Junction Temperature

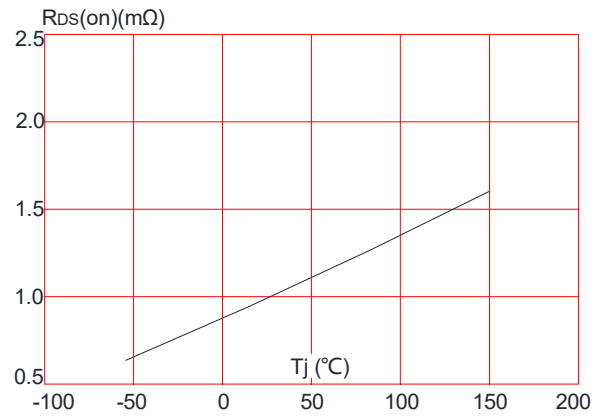

Figure 9: Maximum Safe Operating Area

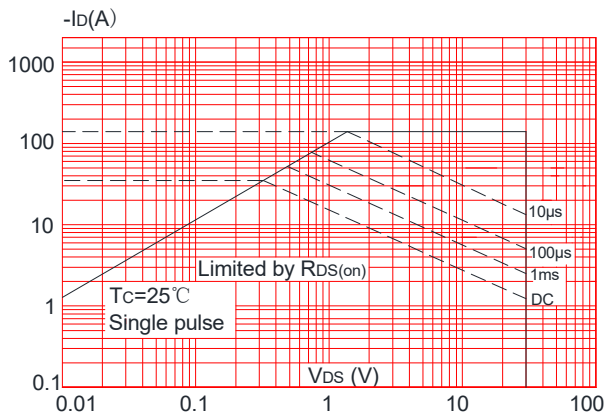

Figure 10: Maximum Continuous Drain Current vs. Case Temperature

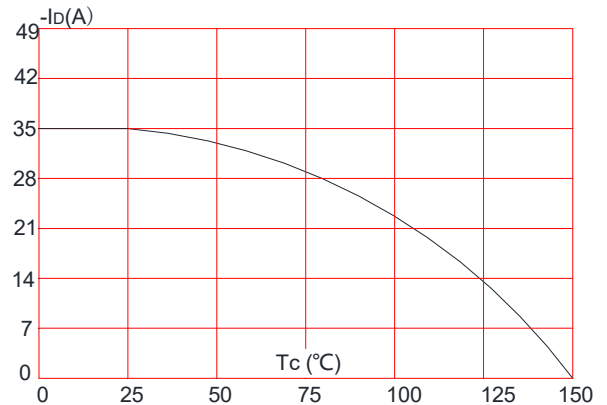
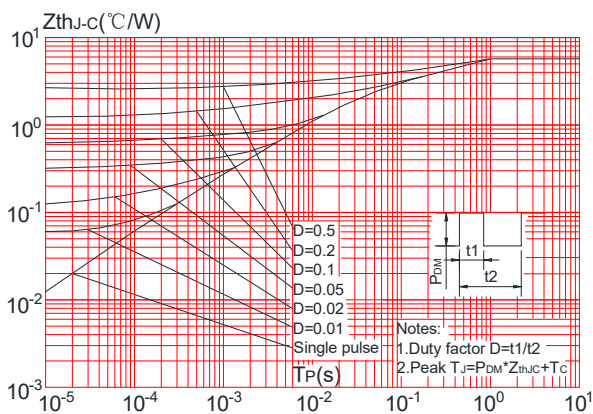
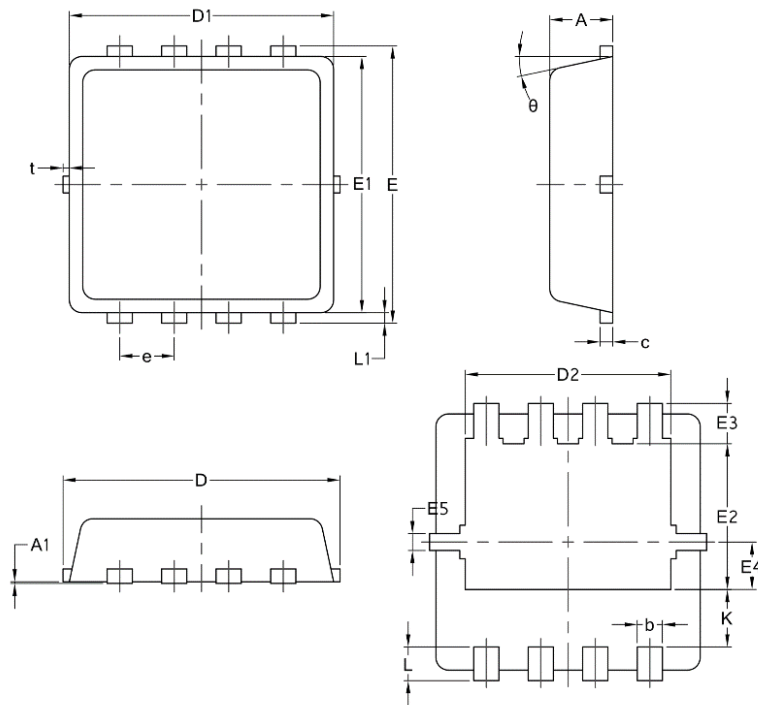

Figure.11: Maximum Effective Transient Thermal Impedance, Junction-to-Case



Package Mechanical Data:DFN3x3-8L



Symbol	Common		
	mm		
	Mim	Nom	Max
A	0.70	0.75	0.85
A1	/	/	0.05
b	0.20	0.30	0.40
c	0.10	0.152	0.25
D	3.15	3.30	3.45
D1	3.00	3.15	3.25
D2	2.29	2.45	2.65
E	3.15	3.30	3.45
E1	2.90	3.05	3.20
E2	1.54	1.74	1.94
E3	0.28	0.48	0.65
E4	0.37	0.57	0.77
E5	0.10	0.20	0.30
e	0.60	0.65	0.70
K	0.59	0.69	0.89
L	0.30	0.40	0.50
L1	0.06	0.125	0.20
t	0	0.075	0.13
Φ	10	12	14