

TM4886

N+N-Channel Enhancement Mode Mosfet

General Description

- Low $R_{DS(ON)}$
- RoHS and Halogen-Free Compliant

Applications

- Load switch
- PWM

Product Summary

$V_{DS} = 100V$ $I_D = 8.0A$

$R_{DS(ON)} = 88\ m\Omega$ (typ.) @ $V_{GS} = 10V$

100% UIS Tested

100% R_g Tested

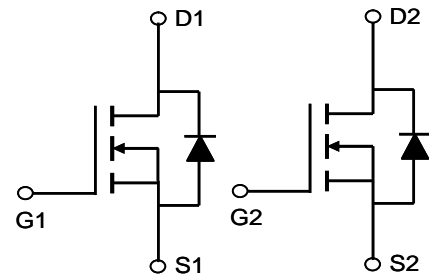
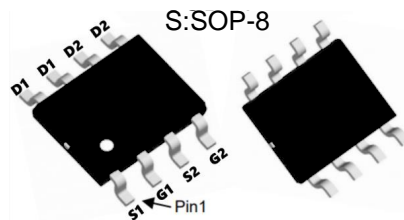
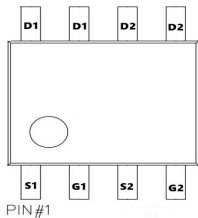

Marking: 08H10 OR 4886

Absolute Maximum Ratings ($T_A = 25^\circ C$ unless otherwise noted)

Symbol	Parameter	Rating	Units
V_{DS}	Drain-Source Voltage	100	V
V_{GS}	Gate-Source Voltage	± 20	V
$I_D @ T_C = 25^\circ C$	Continuous Drain Current, $V_{GS} @ 10V^1$	8	A
$I_D @ T_C = 100^\circ C$	Continuous Drain Current, $V_{GS} @ 10V^1$	5	A
I_{DM}	Pulsed Drain Current ²	15	A
EAS	Single Pulse Avalanche Energy ³	6.1	mJ
$P_D @ T_A = 25^\circ C$	Total Power Dissipation ³	5	W
T_{STG}	Storage Temperature Range	-55 to 150	$^\circ C$
T_J	Operating Junction Temperature Range	-55 to 150	$^\circ C$

Thermal Data

Symbol	Parameter	Typ.	Max.	Unit
$R_{\theta JA}$	Thermal Resistance Junction-ambient ¹	---	125	$^\circ C/W$
$R_{\theta JC}$	Thermal Resistance Junction-Case ¹	---	3.6	$^\circ C/W$

Electrical Characteristics ($T_J=25^\circ\text{C}$ unless otherwise specified)

Symbol	Parameter	Test Condition	Min.	Typ.	Max.	Units
Off Characteristic						
$V_{(BR)DSS}$	Drain-Source Breakdown Voltage	$V_{GS}=0V, I_D=250\mu A$	100	-	-	V
I_{DSS}	Zero Gate Voltage Drain Current	$V_{DS}=100V, V_{GS}=0V,$	-	-	1.0	μA
I_{GSS}	Gate to Body Leakage Current	$V_{DS}=0V, V_{GS}=\pm 20V$	-	-	± 100	nA
On Characteristics						
$V_{GS(th)}$	Gate Threshold Voltage	$V_{DS}=V_{GS}, I_D=250\mu A$	1.0	1.5	2.5	V
$R_{DS(on)}$	Static Drain-Source on-Resistance <small>note3</small>	$V_{GS}=10V, I_D=3A$	-	88	105	m Ω
		$V_{GS}=4.5V, I_D=2A$	-	100	128	m Ω
Dynamic Characteristics						
C_{iss}	Input Capacitance	$V_{DS}=25V, V_{GS}=0V,$ $f=1.0MHz$	-	610	-	pF
C_{oss}	Output Capacitance		-	40	-	pF
C_{rss}	Reverse Transfer Capacitance		-	25	-	pF
Q_g	Total Gate Charge	$V_{DS}=50V, I_D=2A,$ $V_{GS}=10V$	-	12	-	nC
Q_{gs}	Gate-Source Charge		-	2.2	-	nC
Q_{gd}	Gate-Drain("Miller") Charge		-	2.5	-	nC
Switching Characteristics						
$t_{d(on)}$	Turn-on Delay Time	$V_{DS}=50V, I_D=3A,$ $R_G=1.8\Omega, V_{GS}=10V$	-	7	-	ns
t_r	Turn-on Rise Time		-	5	-	ns
$t_{d(off)}$	Turn-off Delay Time		-	16	-	ns
t_f	Turn-off Fall Time		-	6	-	ns
Drain-Source Diode Characteristics and Maximum Ratings						
I_S	Maximum Continuous Drain to Source Diode Forward Current		-	-	3	A
I_{SM}	Maximum Pulsed Drain to Source Diode Forward Current		-	-	8	A
V_{SD}	Drain to Source Diode Forward Voltage	$V_{GS}=0V, I_S=3A$	-	-	1.2	V
t_{rr}	Body Diode Reverse Recovery Time	$I_F=3A, di/dt=100A/\mu s$	-	21	-	ns
Q_{rr}	Body Diode Reverse Recovery Charge		-	21	-	nC

Notes:1. Repetitive Rating: Pulse Width Limited by Maximum Junction Temperature

2. EAS condition : $T_J=25^\circ\text{C}, V_{DD}=50V, V_G=10V, L=0.5mH, R_g=25\Omega, I_{AS}=4A$

3. Pulse Test: Pulse Width $\leq 300\mu s$, Duty Cycle $\leq 0.5\%$

Typical Performance Characteristics

Figure 1: Output Characteristics

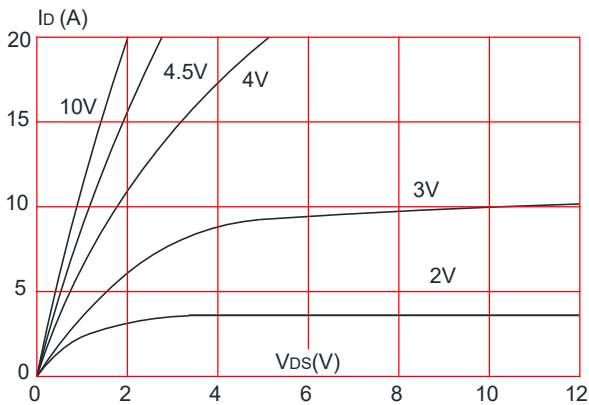

Figure 2: Typical Transfer Characteristics

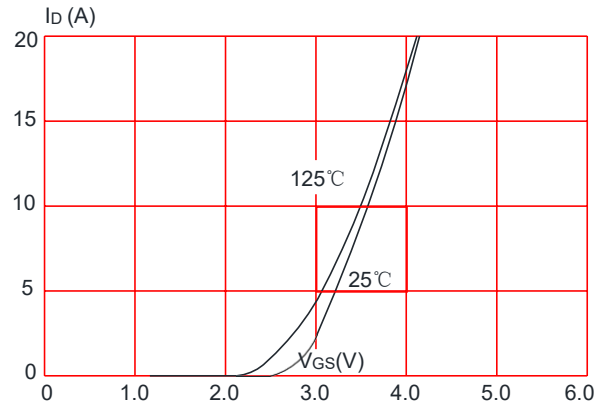

Figure 3: On-resistance vs. Drain Current

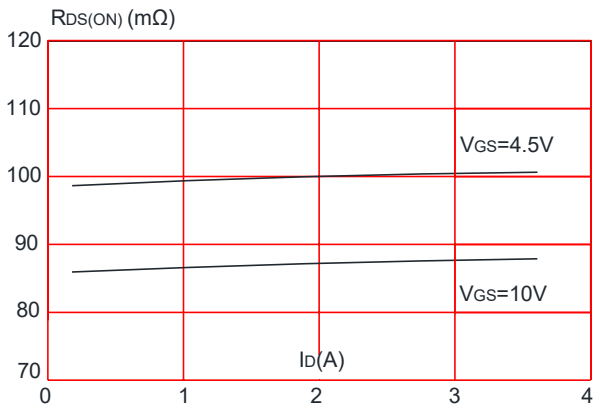

Figure 4: Body Diode Characteristics

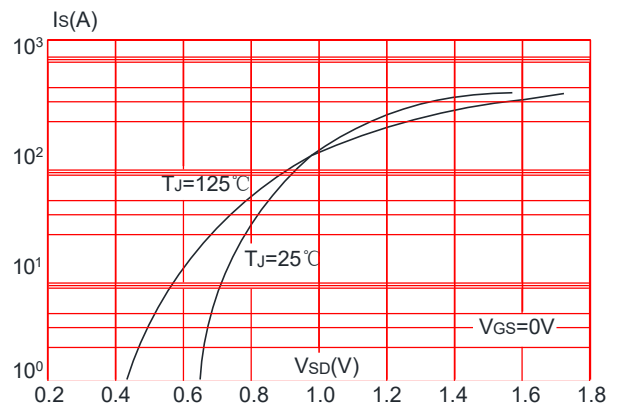

Figure 5: Gate Charge Characteristics

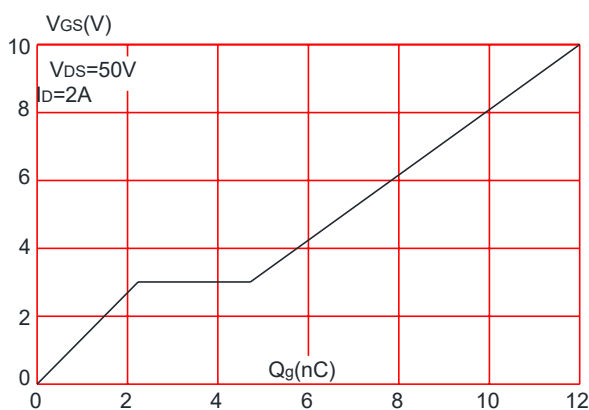
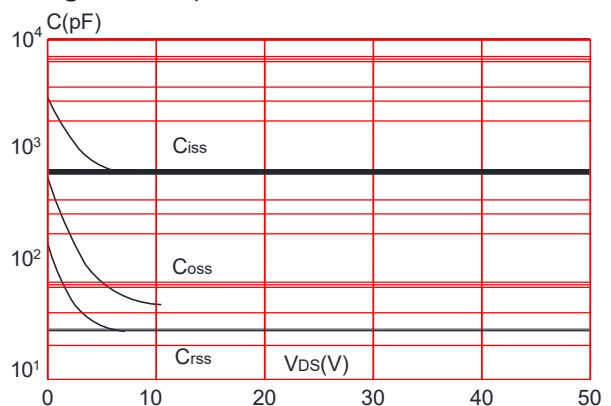

Figure 6: Capacitance Characteristics



TM4886

N+N-Channel Enhancement Mode Mosfet

Figure 7: Normalized Breakdown Voltage vs. Junction Temperature

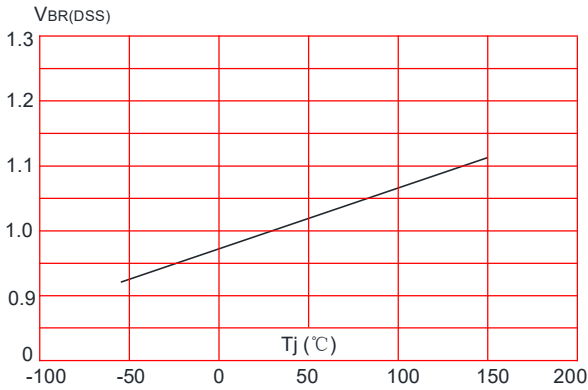

Figure 8: Normalized on Resistance vs. Junction Temperature

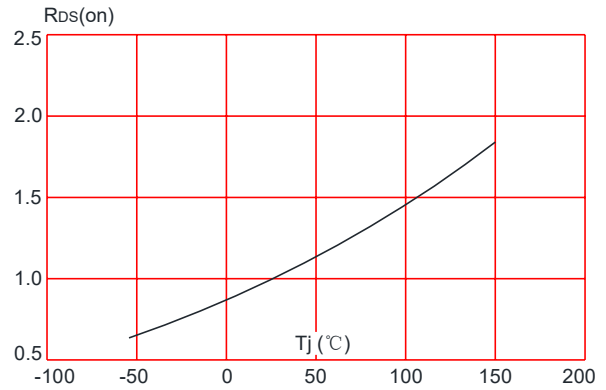

Figure 9: Maximum Safe Operating Area

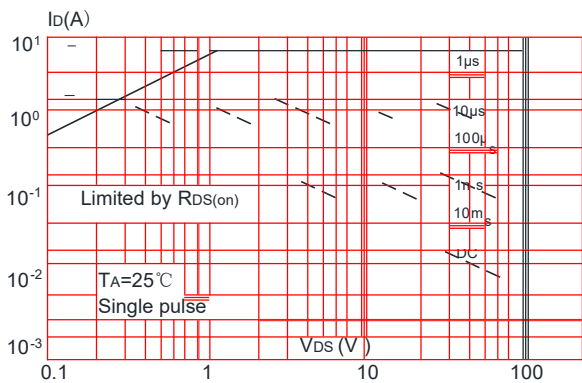

Figure 10: Maximum Continuous Drain Current vs. Ambient Temperature

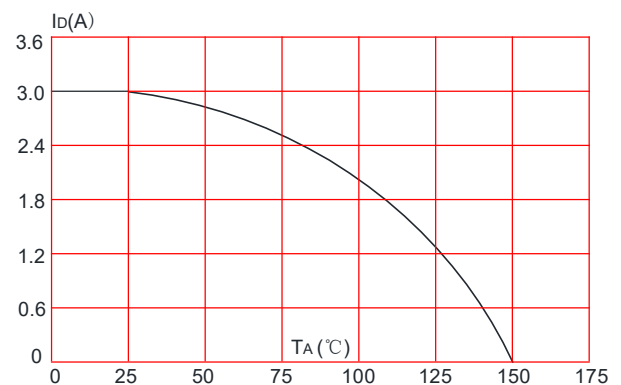
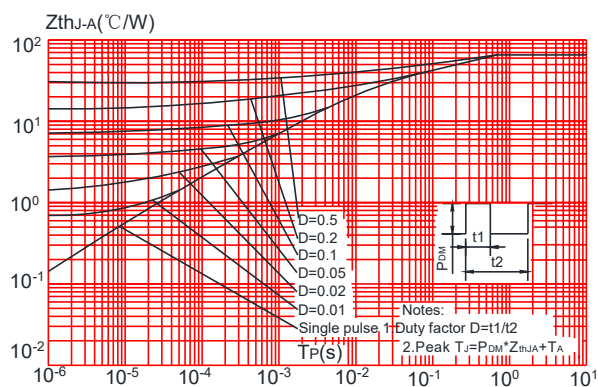
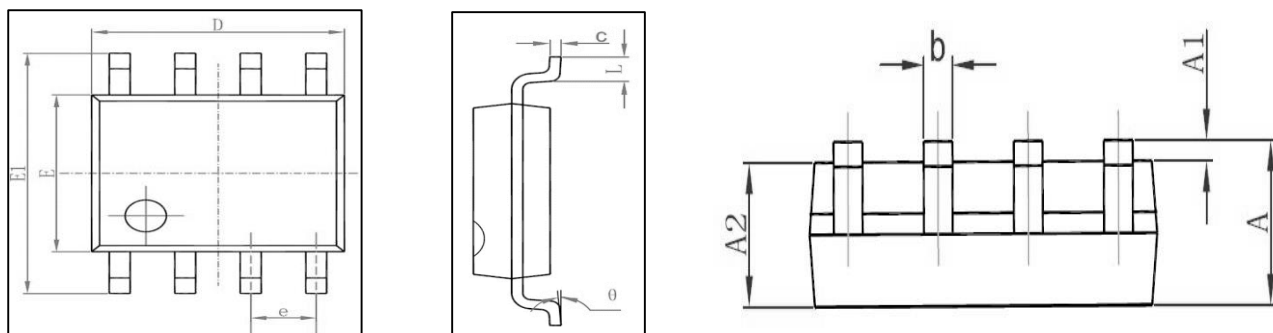

Figure.11: Maximum Effective Transient Thermal Impedance, Junction-to-Ambient



Package Mechanical Data:SOP-8L



Symbol	Dimensions In Millimeters		Dimensions In Inches	
	Min	Max	Min	Max
A	1.350	1.750	0.053	0.069
A1	0.100	0.250	0.004	0.010
A2	1.350	1.550	0.053	0.061
b	0.330	0.510	0.013	0.020
c	0.170	0.250	0.006	0.010
D	4.700	5.100	0.185	0.200
E	3.800	4.000	0.150	0.157
E1	5.800	6.200	0.228	0.244
e	1.270 (BSC)		0.050 (BSC)	
L	0.400	1.270	0.016	0.050
θ	0°	8°	0°	8°

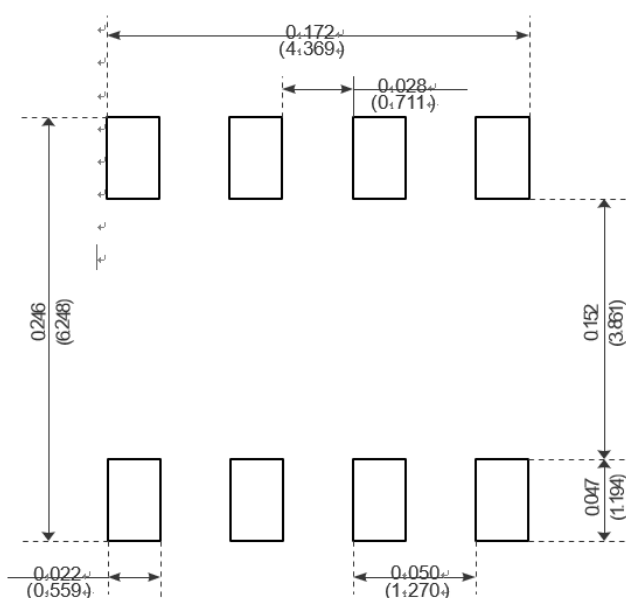

Recommended Minimum Pads