

TMP2050AD

P -Channel Enhancement Mosfet

<p>General Description</p> <ul style="list-style-type: none"> • Low $R_{DS(ON)}$ • RoHS and Halogen-Free Compliant <p>Applications</p> <ul style="list-style-type: none"> • Load switch • PWM 	<p>General Features</p> <p>$V_{DS} = -20V$ $I_D = -48A$</p> <p>$R_{DS(ON)} = 13m\Omega$ (typ.) @ $V_{GS} = -4.5V$</p> <p>100% UIS Tested 100% R_g Tested</p> 
--	--

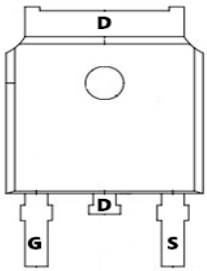

Marking: 50P02

D:TO-252-3L

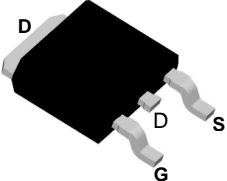

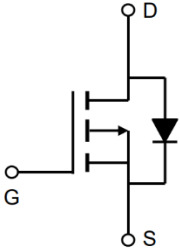

Absolute Maximum Ratings (TC=25°C unless otherwise noted)

Symbol	Parameter	Rating	Unit	
V_{DSS}	Drain-Source Voltage	-20	V	
V_{GSS}	Gate-Source Voltage	±12		
I_D^a	Continuous Drain Current ($V_{GS} = -4.5V$)	$T_A = 25^\circ C$	-48	A
		$T_A = 70^\circ C$	-36	
I_{DM}^a	Pulsed Drain Current ($V_{GS} = -4.5V$)	-44		
I_D^c	Continuous Drain Current	$T_C = 25^\circ C$	-35	
		$T_C = 100^\circ C$	-22	
I_S^a	Diode Continuous Forward Current	-10		
T_J	Maximum Junction Temperature	150	°C	
I_{AS}^d	Avalanche Current, Single pulse	L=0.5mH	-12	A
E_{AS}^d	Avalanche Energy, Single pulse	L=0.5mH	36	mJ
T_{STG}	Storage Temperature Range	-55 to 150	°C	
P_D^a	Maximum Power Dissipation	$T_A = 25^\circ C$	3.1	W
		$T_A = 70^\circ C$	2	
P_D^c	Maximum Power Dissipation	$T_C = 25^\circ C$	31.25	
		$T_C = 100^\circ C$	12.5	
$R_{\theta JA}^{a,b}$	Thermal Resistance-Junction to Ambient	t ≤ 10s	40	°C/W
		Steady State	80	
$R_{\theta JC}^c$	Thermal Resistance-Junction to Case	4	°C/W	

Note * : Package limited.

a : Surface Mounted on 1in² pad area, t ≤ 10sec.

b : Maximum under Steady State conditions is 75 °C/W.

c : The power dissipation P_D is based on $T_{J(MAX)} = 150^\circ C$, and it is useful for reducing junction-to-case thermal resistance ($R_{\theta JC}$) when additional heat sink is used.

d : UIS tested and pulse width limited by maximum junction temperature 150oC (initial temperature $T_J = 25oC$)

Electrical Characteristics ($T_A = 25^\circ\text{C}$ Unless Otherwise Noted)

Symbol	Parameter	Test Conditions	Min.	Typ.	Max.	Unit
Static Characteristics						
BV_{DSS}	Drain-Source Breakdown Voltage	$V_{GS}=0V, I_{DS}=-250\mu A$	-20	-	-	V
I_{DSS}	Zero Gate Voltage Drain Current	$V_{DS}=-16V, V_{GS}=0V$	-	-	-1	μA
		$T_J=85^\circ\text{C}$	-	-	-30	
$V_{GS(th)}$	Gate Threshold Voltage	$V_{DS}=V_{GS}, I_{DS}=-250\mu A$	-0.5	-0.7	-1	V
I_{GSS}	Gate Leakage Current	$V_{GS}=\pm 12V, V_{DS}=0V$	-	-	± 10	μA
$R_{DS(ON)}^e$	Drain-Source On-state Resistance	$V_{GS}=-4.5V, I_{DS}=-11A$	-	13	17	m Ω
		$V_{GS}=-2.5V, I_{DS}=-6A$	-	18	25	
		$V_{GS}=-1.8V, I_{DS}=-1A$	-	26	45	
Diode Characteristics						
V_{SD}^e	Diode Forward Voltage	$I_{SD}=-1A, V_{GS}=0V$	-	-0.7	-1	V
t_{rr}^f	Reverse Recovery Time	$I_{SD}=-11A, di_{SD}/dt=100A/\mu s$	-	63	-	ns
Q_{rr}^f	Reverse Recovery Charge		-	54	-	nC
Dynamic Characteristics^f						
C_{iss}	Input Capacitance	$V_{GS}=0V,$ $V_{DS}=-10V,$ Frequency=1.0MHz	-	1620	-	pF
C_{oss}	Output Capacitance		-	320	-	
C_{rss}	Reverse Transfer Capacitance		-	290	-	
$t_{d(ON)}$	Turn-on Delay Time	$V_{DD}=-10V, R_L=10\Omega,$ $I_{DS}=-1A, V_{GEN}=-4.5V,$ $R_G=6\Omega$	-	9	-	ns
t_r	Turn-on Rise Time		-	13	-	
$t_{d(OFF)}$	Turn-off Delay Time		-	26	-	
t_f	Turn-off Fall Time		-	167	-	
Gate Charge Characteristics^f						
Q_g	Total Gate Charge	$V_{DS}=-10V, V_{GS}=-4.5V,$ $I_{DS}=-11A$	-	25	-	nC
Q_{gs}	Gate-Source Charge		-	1.6	-	
Q_{gd}	Gate-Drain Charge		-	11	-	

 Note e : Pulse test; pulse width $\leq 300\mu s$, duty cycle $\leq 2\%$.

Note f : Guaranteed by design, not subject to production testing.

Typical Operating Characteristics

Power Dissipation

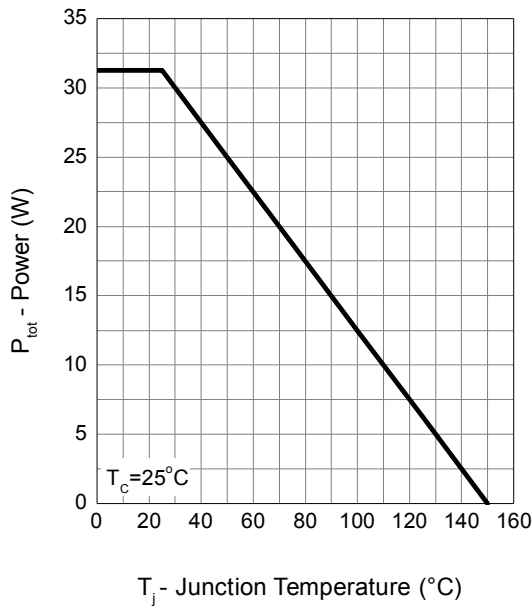

Drain Current

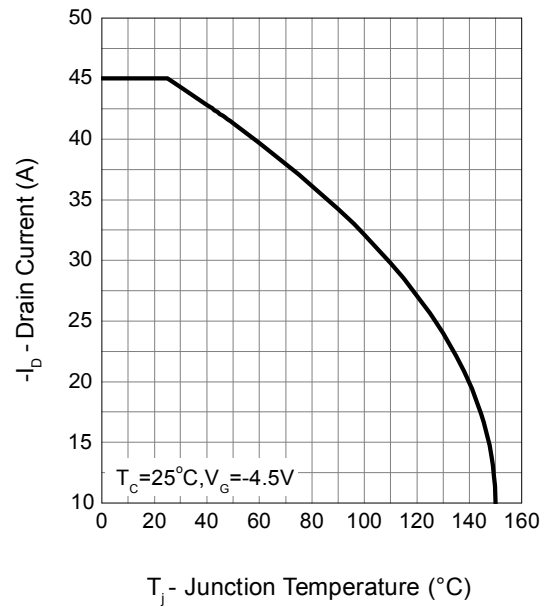

Safe Operation Area

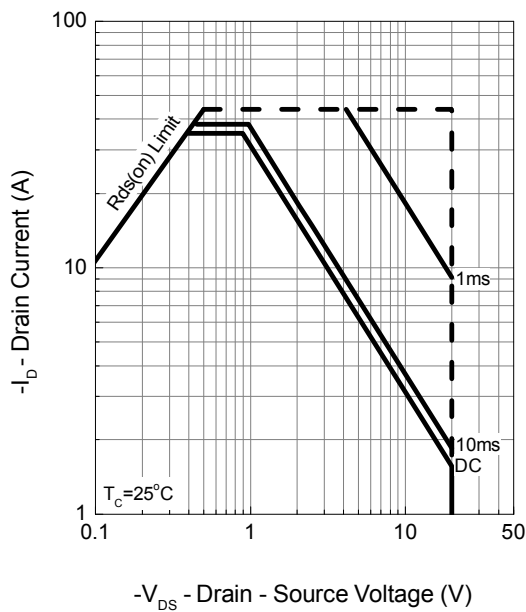

Thermal Transient Impedance

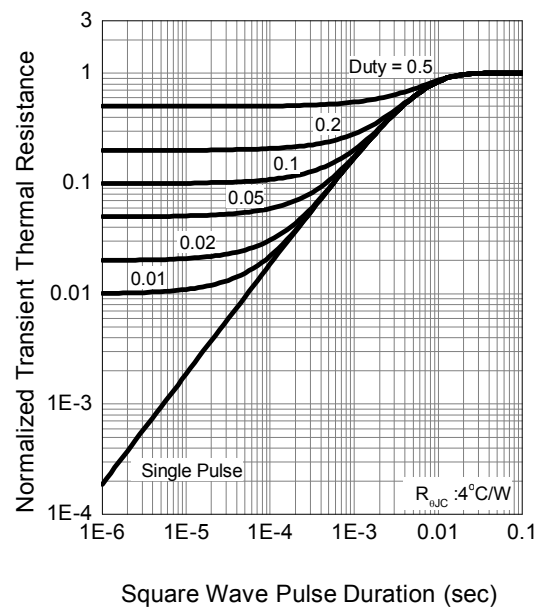



TMP2050AD

P -Channel Enhancement Mosfet

Output Characteristics

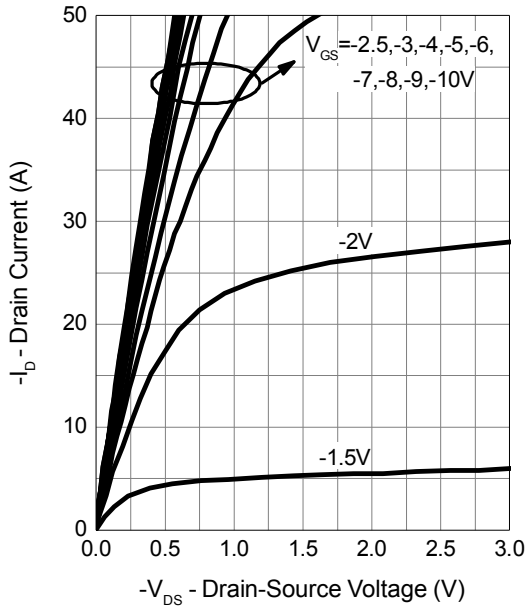

Drain-Source On Resistance

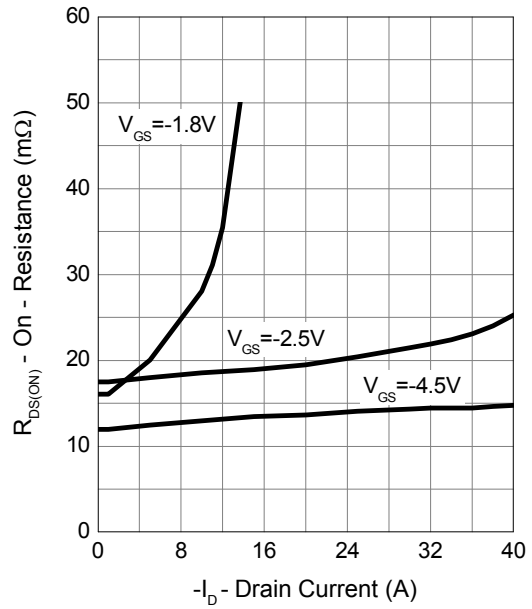

Gate-Source On Resistance

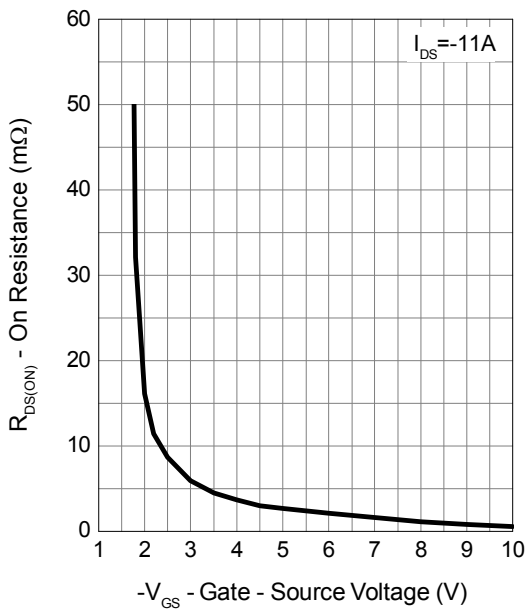

Gate Threshold Voltage

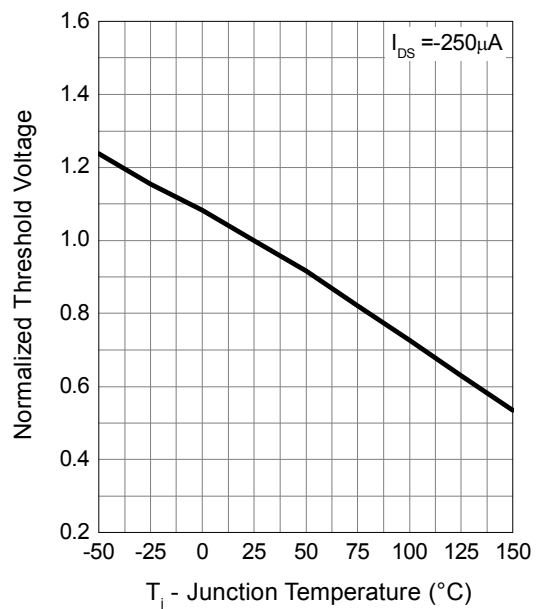



Drain-Source On Resistance

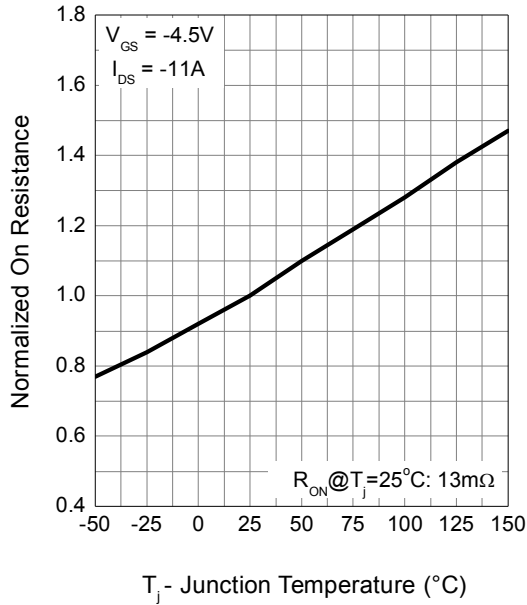

Source-Drain Diode Forward

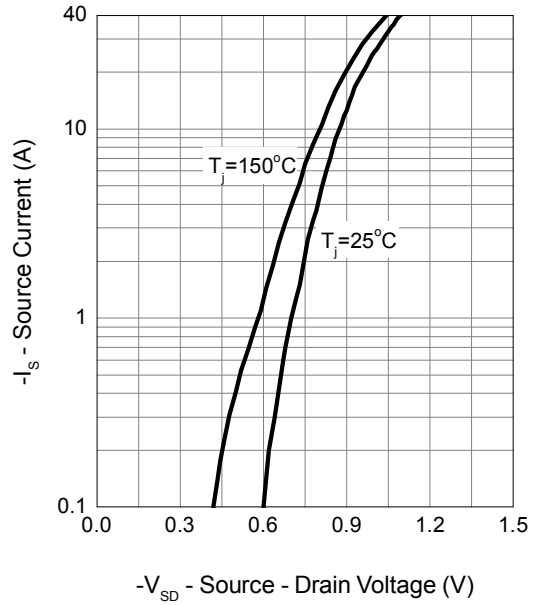

Capacitance

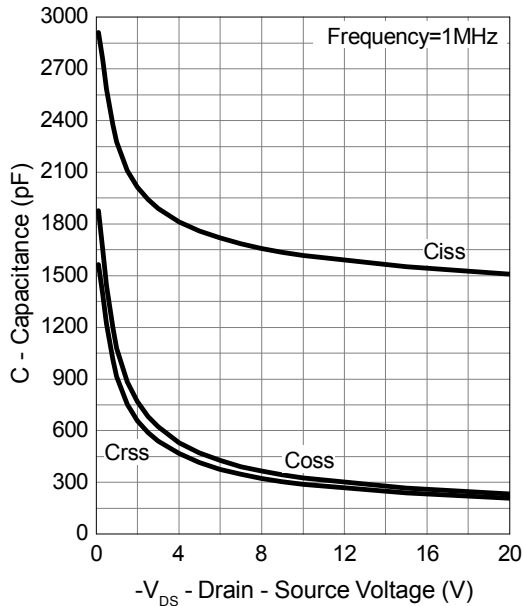

Gate Charge

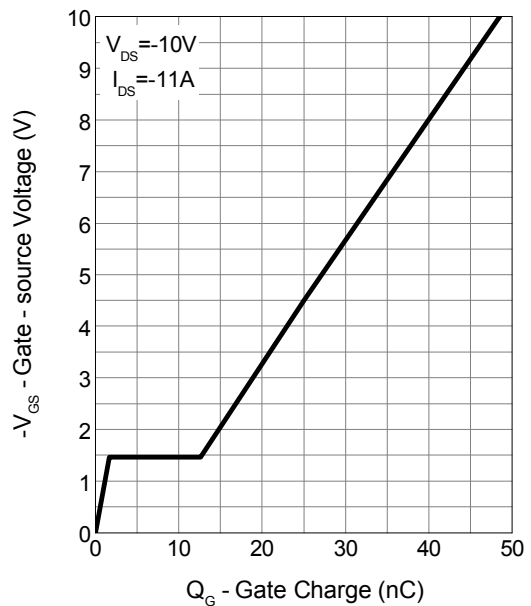

Transfer Characteristics

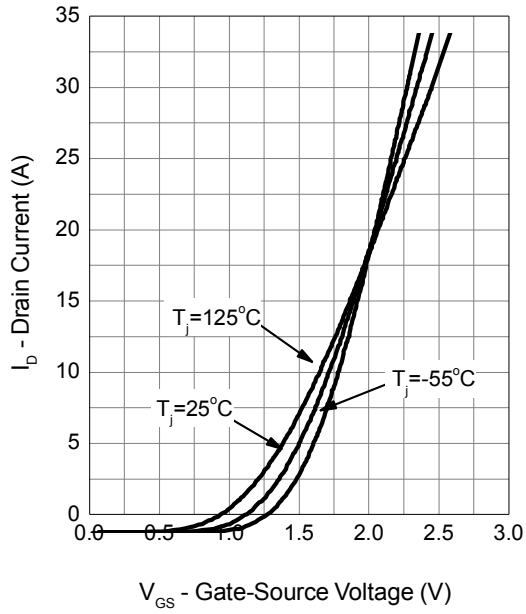



Avalanche Test Circuit and Waveforms

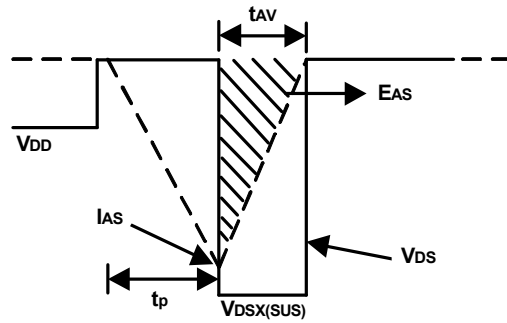
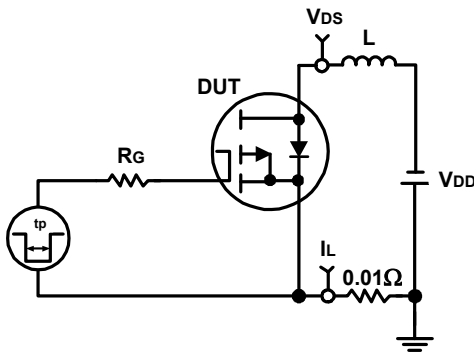

Switching Time Test Circuit and Waveforms

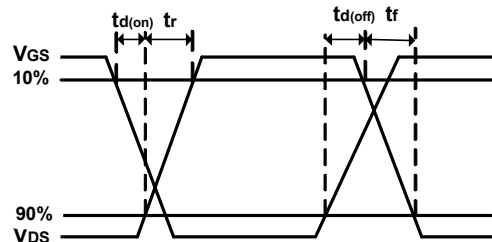
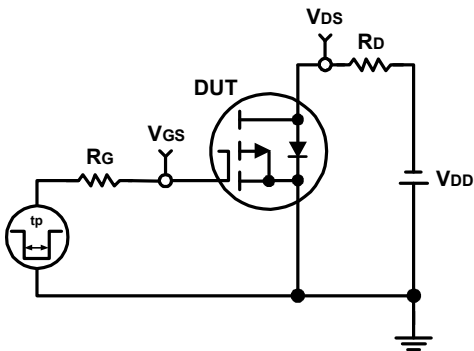

Package Mechanical Data: TO-252-3L

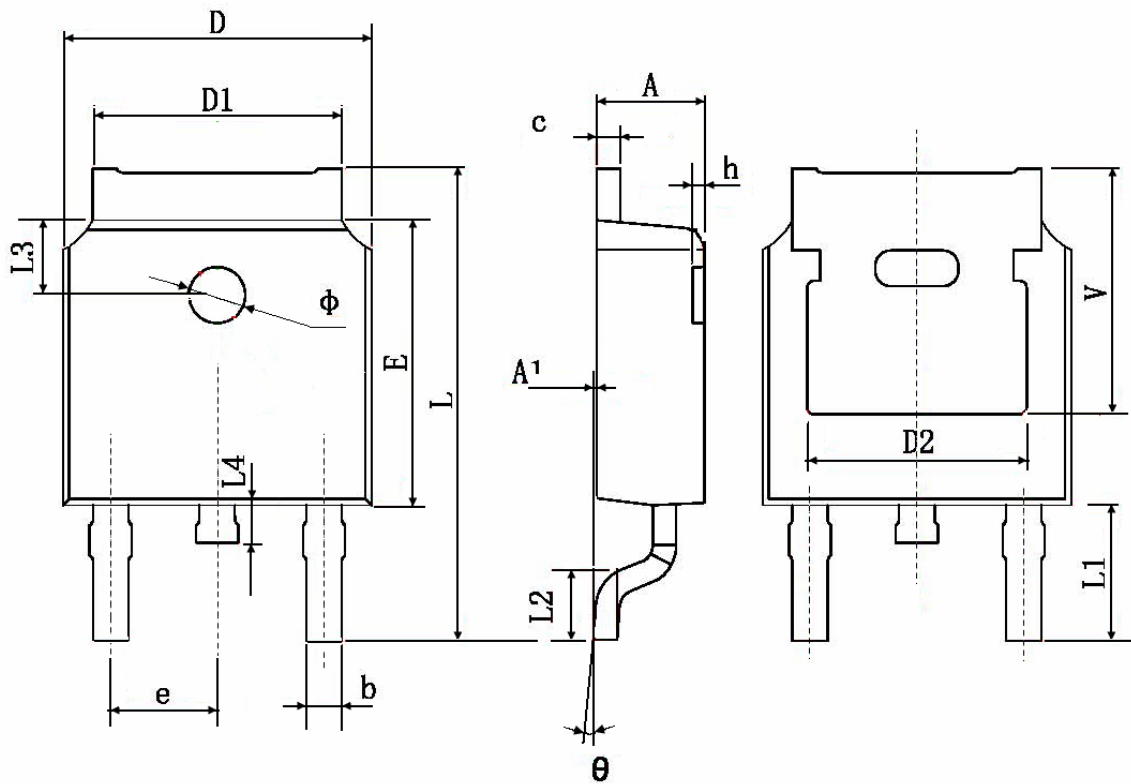

Symbol	Dimensions In Millimeters		Dimensions In Inches	
	Min.	Max.	Min.	Max.
A	2.200	2.400	0.087	0.094
A1	0.000	0.127	0.000	0.005
b	0.660	0.860	0.026	0.034
c	0.460	0.580	0.018	0.023
D	6.500	6.700	0.256	0.264
D1	5.100	5.460	0.201	0.215
D2	4.830 TYP.		0.190 TYP.	
E	6.000	6.200	0.236	0.244
e	2.186	2.386	0.086	0.094
L	9.800	10.400	0.386	0.409
L1	2.900 TYP.		0.114 TYP.	
L2	1.400	1.700	0.055	0.067
L3	1.600 TYP.		0.063 TYP.	
L4	0.600	1.000	0.024	0.039
phi	1.100	1.300	0.043	0.051
theta	0°	8°	0°	8°
h	0.000	0.300	0.000	0.012
V	5.350 TYP.		0.211 TYP.	