

Jun.1.2023 Copyright 2023 HIROSE ELECTRIC CO., LTD. All Rights Reserved.
 In case of consideration for using Automotive equipment / device which demand high reliability, kindly contact our sales window correspondents.

1	2		3		4				
COUNT	DESCRIPTION OF REVISIONS	BY	CHKD	DATE	COUNT	DESCRIPTION OF REVISIONS	BY	CHKD	DATE
1	RENAME	N.H	K.S	05.OCT.24					

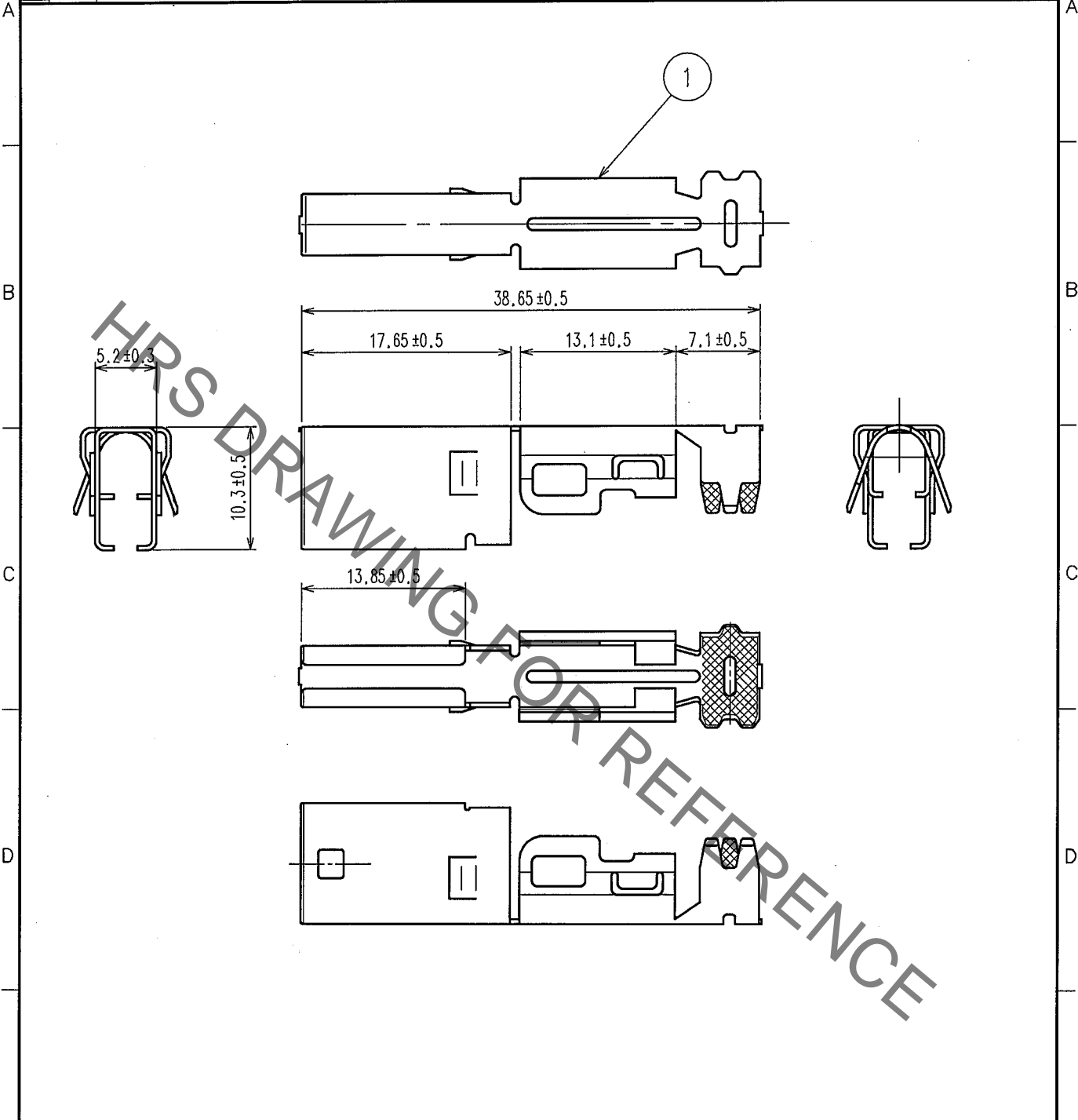

NOTE1. APPLICABLE CABLE DIA : $\phi 4.8$ TO $\phi 5.2$

1	COPPER ALLOY	TIN PLATING
NO.	MATERIAL	FINISH, REMARKS

CODE NO. (OLD)	DRAWN	DESIGNED	CHECKED	APPROVED	RELEASED
OLD PART NO.: GT17USB-4SH-5CF	N.HARUBAYASHI '05.02.22	N.HARUBAYASHI '05.02.22	K.SATO '05.02.23	K.SATO '05.02.23	

 SACLE 2 : 1 UNITS mm	DRAWING NO. EDC4-166358	PART NO. △GT17H-4S-5CF
	 HIROSE ELECTRIC CO., LTD.	CODE NO. CL767-0087-4

TO