

编号	SCTF202305381
日期	2023/5/22
版本	B01



承认书

SPECIFICATION FOR APPROVAL

客户名称 Customer Name:	立创商城
供应商物料名称 Part Name:	石英晶体谐振器
产品描述 Description:	SMD2520 48.000MHz/8pF
供应商物料料号 Part NO.:	SX2B48.000F0810F30
供应商名称 Supplier Name :	深圳市星通时频电子有限公司

PLEASE CONFIRM OUR SPECIFICATION. 敬请确认规格书之内容。

CUSTOMER APPROVAL 客户审批		
物料代号 PART NO. _____		
使用于机型 USED IN MODEL: _____		
工程部	品质部	采购部

(敬请承认后返回一份, 谢谢!)

SUPPLIER APPROVAL 供应商审批		
DGN.制表人	CKD. 校对	APPD. 审核、签章
吴丽红	李霞	胡华才

■ QUARTZ CRYSTAL UNIT SPECIFICATION

1. Crystal Unit Spec:

N0.	Item	Symb.	Electrical Spec.	Notes
1	Nominal Frequency 标称频率	f	48.000000 MHz	
2	Oscillation Mode 振荡模式		AT Fundamental	
3	Holder Type 封装		SMD2520	
4	Frequency Tolerance 常温频差	$\Delta f/f$	$\pm 10\text{ppm}$	at $25^{\circ}\text{C} \pm 2^{\circ}\text{C}$
5	Drive Level 激励功率	DL	10 μW Typical	See the 2.1
6	Load Capacitance 负载电容	CL	8pF	See the 2.2
7	Effective Resistance 谐振电阻	RR	40 Ω max.	See the 2.3
8	Shunt Capacitance 静电容	C0	3 pF Max.	
9	Drive Level Dependency 激励功率依赖性	DLD2	10 Ω max.	Sweep from 100nW to 100uW in 20 steps.
10	Temperature Drift 温度频差	f_tem	$\pm 30\text{ppm}$	Over Operating Temp. Range (Reference 25°C)
11	Spurious response 寄生响应	SPDB	-3dB max.	Start -1000ppm stop 5000ppm 30 steps power applied: 10dBm
12	Operating Temperature 工作温度范围	T_use	$-40 \sim 85^{\circ}\text{C}$	
13	Storage Temperature Range 存储温度	T_stg	$-55 \sim 125^{\circ}\text{C}$	
14	Insulation Resistance 绝缘阻抗	IR	500 M Ω	at DC 100V
15	Aging 老化率	f_age	$\pm 3\text{ppm}$	1st Year
16	Measurement Condition 测量条件	Measured by S&A250B or equivalent, TA= $25^{\circ}\text{C} \pm 2^{\circ}\text{C}$, RH=40%~70%.		

2. Circuit Conditions Spec:

2.1 Drive Level (DL) 100 μW max.

(If Drive Level is too high, that may cause crystal resonator abnormal oscillation or damaged the main body of quartz)

2.2 Loading capacitance (CL) : 8pF

(The total circuit load capacitance should be equal to the crystal (CL) values, too large or too small load, will result in frequency drift.)

2.3 Negative Resistance (-R) $\geq 200\Omega$

(If -R more than ESR spec of 5 times will be better. If Negative Resistance is too low, that may cause crystal resonator stop oscillation or not easy to oscillate)

SHENZHEN SCTF ELECTRONICS CO. , LTD		
DATE	Specification of quartz crystal 石英晶体谐振器规格书	Page:
2023/5/22	P/N: SX2B48.000F0810F30 Spec.NO.: SCTF202305381	3

■ DIMENSIONS

Product size (产品尺寸)

Units (单位): mm(毫米)

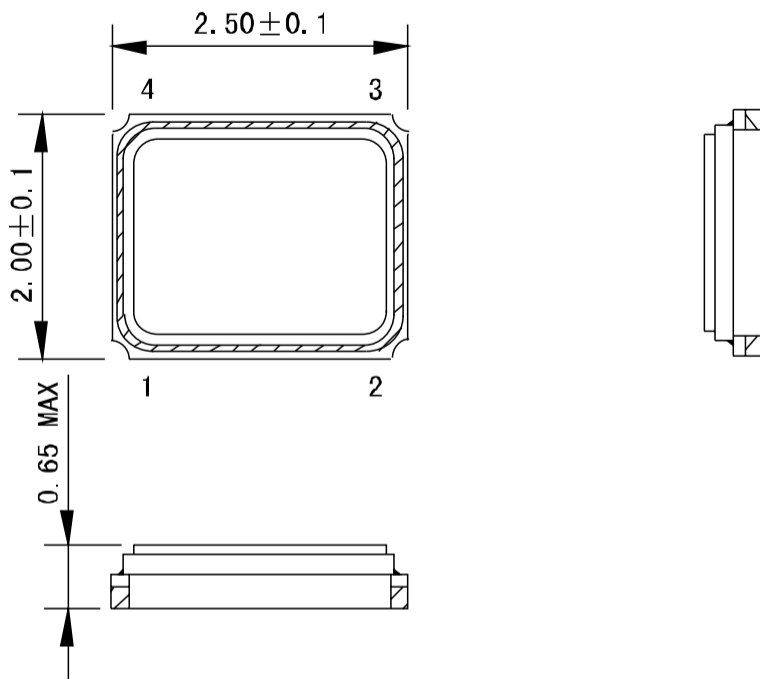

Pad size (焊盘尺寸)

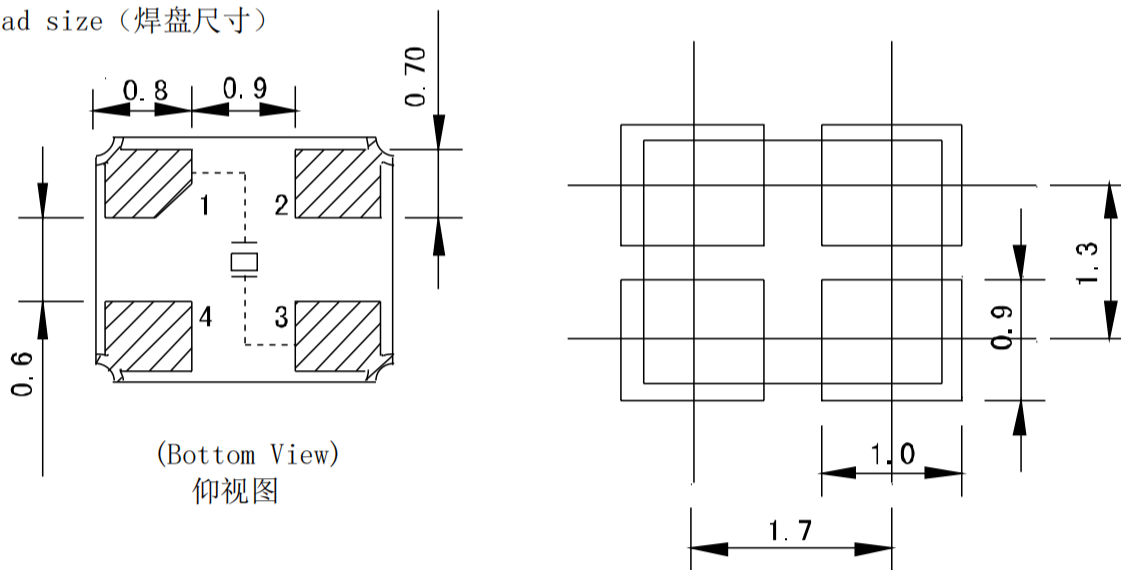

(Bottom View)
仰视图

suggested solder pad layout

Note: #2, #4 is connected with a cover
(Please connect with GND or floating.)

SHENZHEN SCTF ELECTRONICS CO. , LTD		
DATE	Specification of quartz crystal 石英晶体谐振器规格书	Page:
2023/5/22	P/N: SX2B48.000F0810F30 Spec.NO.: SCTF202305381	4

■ PRODUCT STRUCTURE & MARKING

◆ Product Structure 产品结构

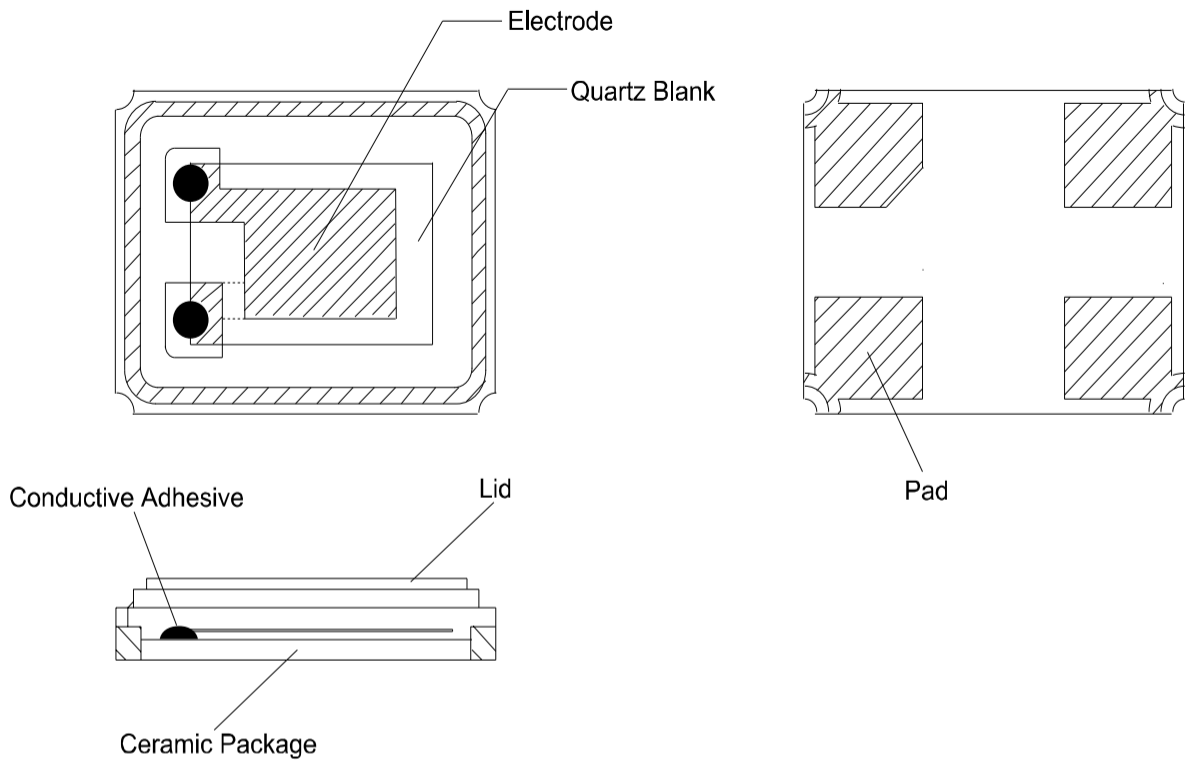

◆ Marking 印字

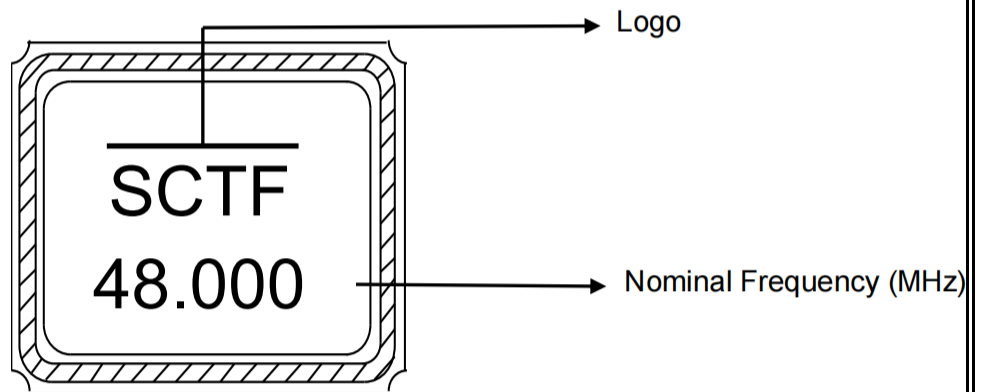

SHENZHEN SCTF ELECTRONICS CO. , LTD		
DATE	Specification of quartz crystal 石英晶体谐振器规格书	Page:
2023/5/22	P/N: SX2B48.000F0810F30 Spec.NO.: SCTF202305381	5

REFLOW PROFILES

Profile Feature	Sn-Pb Eutectic Assembly	Pb-Free Assembly
Preheat/Soak		
● Temperature Min (Ts min)	100 °C	150 °C
● Temperature Max (Ts max)	150 °C	200 °C
● Time (Ts min to Ts max)	60-120 seconds	60-120 seconds
Ramp-up rate (TL to Tp)	3 °C/second max.	3 °C/second max.
Time maintained above		
● Liquidous temperature (TL)	183 °C	217 °C
● Time (tL) maintained above TL	60-150 seconds	60-150 seconds
Peak package body temperature (Tp)	235°C	260°C
Time within 5 °C of the specified classification temperature (Tp)	20 seconds	30 seconds
Ramp-down rate (Tp to TL)	6 °C/second max.	6 °C/second max.
Time 25 °C to peak temperature	6 minutes max.	8 minutes max.
Suggest reflow times	3 Times max.	



SHENZHEN SCTF ELECTRONICS CO., LTD

DATE	Specification of quartz crystal 石英晶体谐振器规格书	Page:
2023/5/22	P/N: SX2B48.000F0810F30 Spec.NO.: SCTF202305381	6

■ RELIABILITY SPECIFICATION

序号 NO.	项目 ITEM	条件 CONDITIONS	合格标准 BASIS OF VERDICT
1	跌落 DROP	100cm高处自由跌落到3cm厚木板上,3次 High:100cm;Thickness:3cm;3 times.	$\Delta FL \leq \pm 5 \text{ppm}$ $\Delta RR \leq RR(\text{max}) * 10\%$
2	振动 VIBRATION	频率 Frequency:10~57.7Hz:幅度 Amplitude: $\pm 0.75 \text{mm}$ 频率Frequency:57.7Hz~500Hz:加速度幅度acceleration rate:98m/s ² 周期 Cycle time:10-500-10Hz: 15min 振动方向 Direction:X,Y, Z 振动时间 Duration: 每个方向2小时 2 h/direction.	$\Delta FL \leq \pm 5 \text{ppm}$ $\Delta RR \leq RR(\text{max}) * 10\%$
3	温度变化 TEMPERATURE SHOCK	-40℃ $\pm 2^\circ\text{C}$ (30min) \leftrightarrow 85℃ $\pm 2^\circ\text{C}$ (30min);循环10次 -40℃ $\pm 2^\circ\text{C}$ (30min) \leftrightarrow 85℃ $\pm 2^\circ\text{C}$ (30min);For 10 cycles	$\Delta FL \leq \pm 5 \text{ppm}$ $\Delta RR \leq RR(\text{max}) * 10\%$
4	湿热 HUMIDITY	温度:40℃ $\pm 2^\circ\text{C}$;湿度90-95%;时间:96小时 Temp:40℃ $\pm 2^\circ\text{C}$;Humidity:90-95%;Times:96h	$\Delta FL \leq \pm 5 \text{ppm}$ $\Delta RR \leq RR(\text{max}) * 10\%$
5	低温 COLD RESISTANCE	温度:-40℃ $\pm 2^\circ\text{C}$;时间:96小时 Temp:-40℃ $\pm 2^\circ\text{C}$;Times:96h	$\Delta FL \leq \pm 5 \text{ppm}$ $\Delta RR \leq RR(\text{max}) * 10\%$
6	高温1 HEAT RESISTANCE 1	温度:100℃ $\pm 2^\circ\text{C}$;时间:96小时 Temp:100℃ $\pm 2^\circ\text{C}$;Times:96h	$\Delta FL \leq \pm 5 \text{ppm}$ $\Delta RR \leq RR(\text{max}) * 10\%$
7	高温2 HEAT RESISTANCE 2	温度:155℃ $\pm 2^\circ\text{C}$;时间:2小时 Temp:155℃ $\pm 2^\circ\text{C}$;Times:2h	$\Delta FL \leq \pm 5 \text{ppm}$ $\Delta RR \leq RR(\text{max}) * 10\%$
8	高温3 HEAT RESISTANCE 3	温度:85℃ $\pm 2^\circ\text{C}$;电压:3.3V/5.0V;时间:96小时 Temp:85℃ $\pm 2^\circ\text{C}$;Voltage:3.3V/5.0V;Times:96h	$\Delta FL \leq \pm 5 \text{ppm}$ $\Delta RR \leq RR(\text{max}) * 10\%$
9	回流焊 REFLOW	150℃ $\pm 5^\circ\text{C}$ 保持120s后升到270℃ $\pm 5^\circ\text{C}$ 保持10s, 升温 and 保 温时间小于200s, 常温放置1~2h后测定 Keep 150 °C \pm 5 °C 120s and then rose to 270 °C \pm 5 °C for 10s, warming and holding time is less than the 200s, placed at room temperature 1 ~ 2h after test	$\Delta FL \leq \pm 5 \text{ppm}$ $\Delta RR \leq RR(\text{max}) * 10\%$
10	盐雾 SALT SPRAY	盐雾浓度:5%;温度:35℃;时间:24小时 Salt density:5%;Temp:35℃;Times:24h	目测无明显腐蚀现象 Visual no significant corrosion.
11	老化 AGING	温度:85℃;时间:30天 Temp:85℃;Times:30days	$\Delta FL \leq \pm 5 \text{ppm}$ $\Delta RR \leq RR(\text{max}) * 10\%$
12	气密性 LEAKAGE	氦气(0.6~0.65MPa):10分钟 He(0.6~0.65MPa):10min	$\leq 3 * 10^{-9} \text{Pa} \cdot \text{m}^3 / \text{s}$
13	焊接 SOLDER	温度:260℃ $\pm 5^\circ\text{C}$ Temp:260℃ $\pm 5^\circ\text{C}$	浸锡率大于90% Soldering tin rate greater than 90%

SHENZHEN SCTF ELECTRONICS CO. , LTD

DATE	Specification of quartz crystal 石英晶体谐振器规格书	Page:
2023/5/22	P/N: SX2B48.000F0810F30 Spec.NO.: SCTF202305381	7

PACKAGE

◆ Taping Specifications 编带规格

UNIT(单位) :mm (毫米)

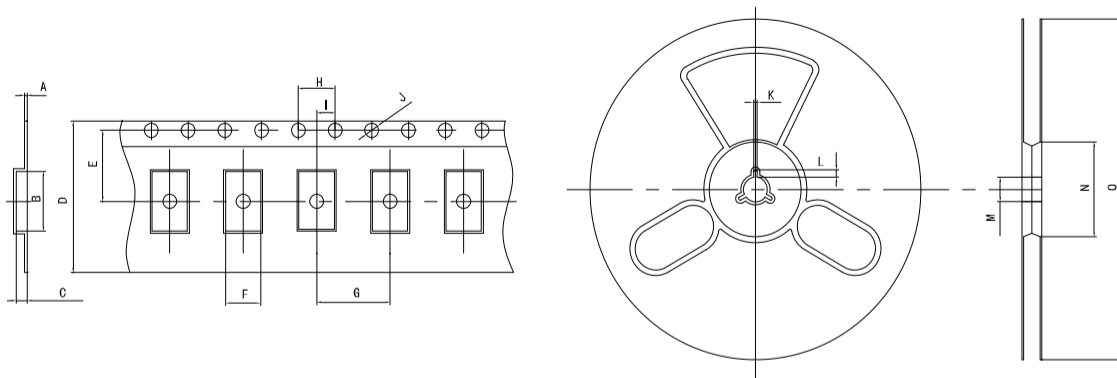

TEYE	A	B	C	D	E	F	G	H	I	J	K	L	M	N	O
2.5×2.0 SMD	0.30	2.80	0.75	8.00	3.50	2.30	4.00	4.00	2.00	1.50	2.00	4.00	13.00	60.00	180.00

◆ Packaging specifications 包装规格

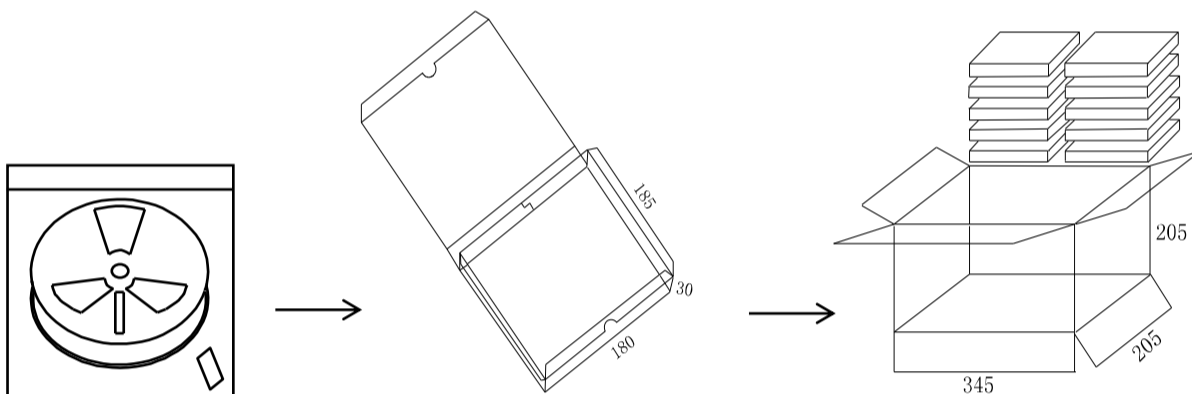

自封袋(Bag)
3000只 = 1 轮
3000pcs = 1 Reel

内包装(Inside package)
1 轮=1 盒
1 Reel=1 box

外包装(Outside Package)
10 盒=1 箱
10 box=1 carton

SHENZHEN SCTF ELECTRONICS CO. , LTD

DATE

Specification of quartz crystal
石英晶体谐振器规格书

Page:

2023/5/22

P/N: SX2B48.000F0810F30
Spec.NO.: SCTF202305381

8