

### FEATURES

- Output Voltage Range 3.3V, 5V, 12V, 15V,
- Output current up to 100mA
- No external components required
- Internal thermal overload protection
- Internal short-circuit current limiting
- Output transistor safe-area compensation
- Output voltage offered in 4% tolerance
- RoHS

### APPLICATION

- Switching power supply
- Home appliance

### Typical Application

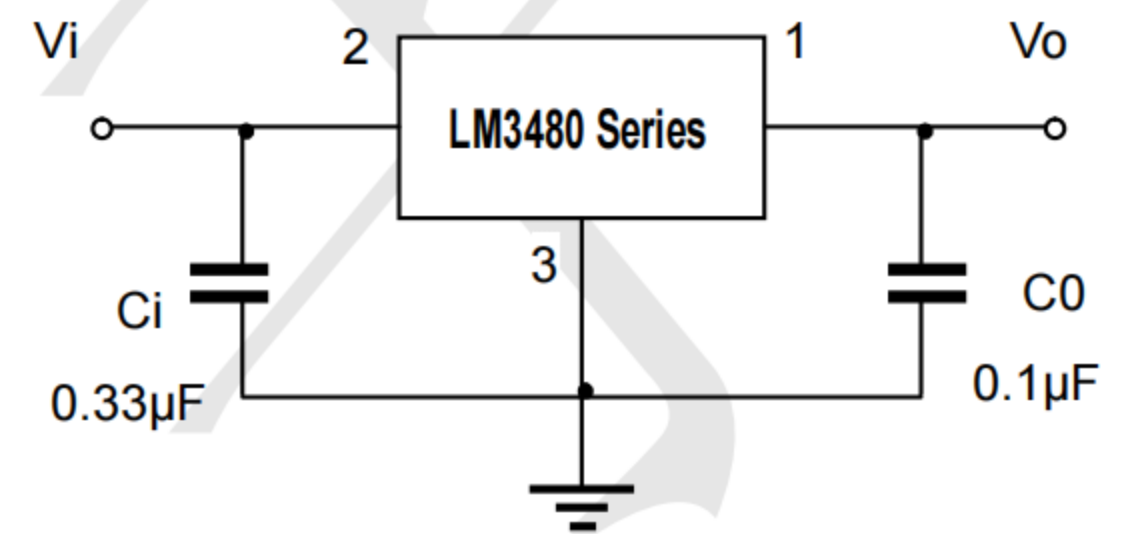

### ORDERING INFORMATION

TECH PUBLIC PART NO.	PACKAGE	PACKING
LM3480IM3X-3.3	SOT-23	3,000pcs / 7"Reel
LM3480IM3X-5.0	SOT-23	3,000pcs / 7"Reel
LM3480IM3X-12	SOT-23	3,000pcs / 7"Reel
LM3480IM3X-15	SOT-23	3,000pcs / 7"Reel

### Dimensions and Pin Configuration

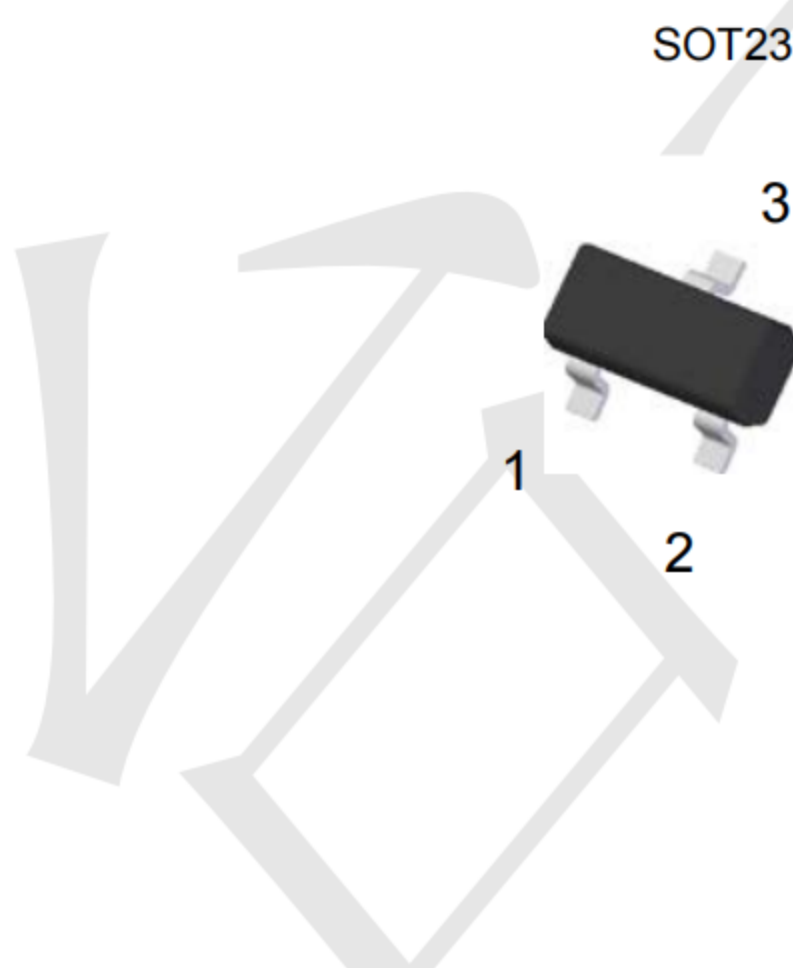

1. OUT
2. IN
3. GND

### Marking:

LM3480IM3X-3.3:L0A Or 18H  
 LM3480IM3X-5.0:L0B Or 18I  
 LM3480IM3X-12:L0C Or 18G  
 LM3480IM3X-15:L0D Or 18C

**TECH PUBLIC**

—台丹电子—

**LM3480 Series****100-mA, SOT-23, Quasi Low-Dropout Linear Voltage Regulator**[www.sot23.com.tw](http://www.sot23.com.tw)**ABSOLUTE MAXIMUM RATINGS**

TECH PUBLIC	PARAMETER	SYMBOL	LIMIT	UNIT
DC Input Voltage	LM3480IM3X-3.3	V <sub>in</sub>	30	V
	LM3480IM3X-5.0		35	
	LM3480IM3X-12		35	
	LM3480IM3X-15		35	
Power Dissipation		P <sub>D</sub>	Internally Limited	W
Operating Junction Temperature		T <sub>J</sub>	+150	°C
Recommended Operating Junction Temperature Range		T <sub>J</sub>	-40 ~ +125	°C
Operating Ambient Temperature Range		T <sub>A</sub>	-40 ~ +85	°C
Storage Temperature Range		T <sub>STG</sub>	-65~+150	°C

**THERMAL PERFORMANCE**

PARAMETER	SYMBOL	TYPICAL	UNIT
Junction to Case Thermal Resistance	R <sub>θJC</sub>	120	°C/W
Junction to Ambient Thermal Resistance	R <sub>θJA</sub>	330	°C/W

**ELECTRICAL SPECIFICATIONS**

LM3480IM3X-3.3

(V<sub>IN</sub>=8.3V, I<sub>OUT</sub>=40mA, 0°C≤T<sub>J</sub>≤125°C, C<sub>IN</sub>=0.33μF, C<sub>OUT</sub>=0.1μF, unless otherwise noted)

PARAMETER	CONDITIONS	SYMBOL	MIN	TYP	MAX	UNIT
Output voltage	T <sub>J</sub> =25°C	V <sub>OUT</sub>	3.173	3.3	3.432	V
	5.8V≤V <sub>IN</sub> ≤20V, 5mA≤I <sub>OUT</sub> ≤100mA		3.142	3.3	3.465	V
Line Regulation	T <sub>J</sub> =25°C 5.8V≤V <sub>IN</sub> ≤20V I <sub>OUT</sub> =40mA	REG <sub>LINE</sub>	--	50	150	mV
Load Regulation	T <sub>J</sub> =25°C 5mA≤I <sub>OUT</sub> ≤100mA	REG <sub>LOAD</sub>	--	15	60	mV
			5mA≤I <sub>OUT</sub> ≤40mA	--	5	
Quiescent Current	I <sub>OUT</sub> =0, T <sub>J</sub> =25°C	I <sub>Q</sub>	--	3	6	mA
Quiescent Current Change	5.8V≤V <sub>IN</sub> ≤20V	ΔI <sub>Q</sub>	--	--	1.5	mA
	5mA≤I <sub>OUT</sub> ≤40mA		--	--	0.1	
Output Noise Voltage	10Hz≤f≤100kHz, T <sub>J</sub> =25°C	V <sub>N</sub>	--	40	--	μV
Ripple Rejection Ratio	F=120Hz, 5.8V≤V <sub>IN</sub> ≤20V	RR	41	49	--	dB
Voltage Drop	I <sub>OUT</sub> =100mA, T <sub>J</sub> =25°C	V <sub>DROP</sub>	--	2	--	V
Peak Output Current	T <sub>J</sub> =25°C	I <sub>o peak</sub>	--	0.15	--	A
Temperature Coefficient of Output Voltage	I <sub>OUT</sub> =5mA, 0°C≤T <sub>J</sub> ≤150°C	ΔV <sub>OUT</sub> /ΔT <sub>J</sub>	--	-0.2	--	mV/°C

**TECH PUBLIC**

—台丹电子—

**LM3480 Series****100-mA, SOT-23, Quasi Low-Dropout Linear Voltage Regulator**[www.sot23.com.tw](http://www.sot23.com.tw)

LM3480IM3X-5.0

(V<sub>IN</sub>=10V, I<sub>OUT</sub>=40mA, 0°C≤T<sub>J</sub>≤125°C, C<sub>IN</sub>=0.33μF, C<sub>OUT</sub>=0.1μF, unless otherwise noted)

PARAMETER	CONDITIONS		SYMBOL	MIN	TYP	MAX	UNIT
Output voltage	T <sub>J</sub> =25°C		V <sub>OUT</sub>	4.80	5	5.20	V
	7.5V≤V <sub>IN</sub> ≤20V, 5mA≤I <sub>OUT</sub> ≤100mA			4.75	5	5.25	V
Line Regulation	T <sub>J</sub> =25°C	7.5V≤V <sub>IN</sub> ≤20V I <sub>OUT</sub> =100mA	REG <sub>LINE</sub>	50	150	150	mV
Load Regulation	T <sub>J</sub> =25°C	5mA≤I <sub>OUT</sub> ≤100mA	REG <sub>LOAD</sub>	20	60	60	mV
		5mA≤I <sub>OUT</sub> ≤40mA		10	30	30	
Quiescent Current	I <sub>OUT</sub> =0, T <sub>J</sub> =25°C		I <sub>Q</sub>	--	3	6	mA
Quiescent Current Change	7.5V≤V <sub>IN</sub> ≤20V		ΔI <sub>Q</sub>	--	--	1.5	mA
	5mA≤I <sub>OUT</sub> ≤40mA			--	--	0.1	
Output Noise Voltage	10Hz≤f≤100kHz, T <sub>J</sub> =25°C		V <sub>N</sub>	--	40	--	μV
Ripple Rejection Ratio	F=120Hz, 7.5V≤V <sub>IN</sub> ≤20V		RR	41	49	--	dB
Voltage Drop	I <sub>OUT</sub> =100mA, T <sub>J</sub> =25°C		V <sub>DROP</sub>	--	1.7	--	V
Peak Output Current	T <sub>J</sub> =25°C		I <sub>o peak</sub>	--	0.15	--	A
Temperature Coefficient of Output Voltage	I <sub>OUT</sub> =5mA, 0°C≤T <sub>J</sub> ≤150°C		ΔV <sub>OUT</sub> /ΔT <sub>J</sub>	--	-0.65	--	mV/°C

LM3480IM3X-12

(V<sub>IN</sub>=19V, I<sub>OUT</sub>=40mA, 0°C≤T<sub>J</sub>≤125°C, C<sub>IN</sub>=0.33μF, C<sub>OUT</sub>=0.1μF, unless otherwise noted)

PARAMETER	CONDITIONS		SYMBOL	MIN	TYP	MAX	UNIT
Output voltage	T <sub>J</sub> =25°C		V <sub>OUT</sub>	11.53	12	12.48	V
	14.5V≤V <sub>IN</sub> ≤27V, 5mA≤I <sub>OUT</sub> ≤100mA			11.42	12	12.60	V
Line Regulation	T <sub>J</sub> =25°C	14.5V≤V <sub>IN</sub> ≤27V I <sub>OUT</sub> =40mA	REG <sub>LINE</sub>	--	120	240	mV
Load Regulation	T <sub>J</sub> =25°C	5mA≤I <sub>OUT</sub> ≤100mA	REG <sub>LOAD</sub>	--	40	120	mV
		5mA≤I <sub>OUT</sub> ≤40mA		--	20	60	
Quiescent Current	I <sub>OUT</sub> =0, T <sub>J</sub> =25°C		I <sub>Q</sub>	--	3	6.5	mA
Quiescent Current Change	14.5V≤V <sub>IN</sub> ≤27V		ΔI <sub>Q</sub>	--	--	1.5	mA
	5mA≤I <sub>OUT</sub> ≤40mA			--	--	0.1	
Output Noise Voltage	10Hz≤f≤100kHz, T <sub>J</sub> =25°C		V <sub>N</sub>	--	80	--	μV
Ripple Rejection Ratio	F=120Hz, 14.5V≤V <sub>IN</sub> ≤27V		RR	37	42	--	dB
Voltage Drop	I <sub>OUT</sub> =100mA, T <sub>J</sub> =25°C		V <sub>DROP</sub>	--	1.7	--	V
Peak Output Current	T <sub>J</sub> =25°C		I <sub>o peak</sub>	--	0.15	--	A
Temperature Coefficient of Output Voltage	I <sub>OUT</sub> =5mA, 0°C≤T <sub>J</sub> ≤150°C		ΔV <sub>OUT</sub> /ΔT <sub>J</sub>	--	-1.0	--	mV/°C

LM3480IM3X-15

( $V_{IN}=23V$ ,  $I_{OUT}=40mA$ ,  $0^{\circ}C \leq T_J \leq 125^{\circ}C$ ,  $C_{IN}=0.33\mu F$ ,  $C_{OUT}=0.1\mu F$ , unless otherwise noted)

PARAMETER	CONDITIONS	SYMBOL	MIN	TYP	MAX	UNIT
Output voltage	$T_J=25^{\circ}C$	$V_{OUT}$	14.42	15	15.60	V
	$17.5V \leq V_{IN} \leq 30V$ , $5mA \leq I_{OUT} \leq 100mA$		14.28	15	15.75	V
Line Regulation	$T_J=25^{\circ}C$ $17.5V \leq V_{IN} \leq 30V$ $I_{OUT}=40mA$	$REG_{LINE}$	--	150	300	mV
Load Regulation	$T_J=25^{\circ}C$ $5mA \leq I_{OUT} \leq 100mA$ $5mA \leq I_{OUT} \leq 40mA$	$REG_{LOAD}$	--	50	150	mV
			--	25	75	
Quiescent Current	$I_{OUT}=0$ , $T_J=25^{\circ}C$	$I_Q$	--	3	6.6	mA
Quiescent Current Change	$17.5V \leq V_{IN} \leq 30V$	$\Delta I_Q$	--	--	1.5	mA
	$5mA \leq I_{OUT} \leq 40mA$		--	--	0.1	
Output Noise Voltage	$10Hz \leq f \leq 100kHz$ , $T_J=25^{\circ}C$	$V_N$	--	90	--	$\mu V$
Ripple Rejection Ratio	$F=120Hz$ , $17.5V \leq V_{IN} \leq 30V$	RR	34	39	--	dB
Voltage Drop	$I_{OUT}=100mA$ , $T_J=25^{\circ}C$	$V_{DROP}$	--	1.7	--	V
Peak Output Current	$T_J=25^{\circ}C$	$I_{O\ peak}$	--	0.15	--	A
Temperature Coefficient of Output Voltage	$I_{OUT}=5mA$ , $0^{\circ}C \leq T_J \leq 150^{\circ}C$	$\Delta V_{OUT} / \Delta T_J$	--	-1.3	--	mV/ $^{\circ}C$



ELECTRICAL CHARACTERISTICS CURVE

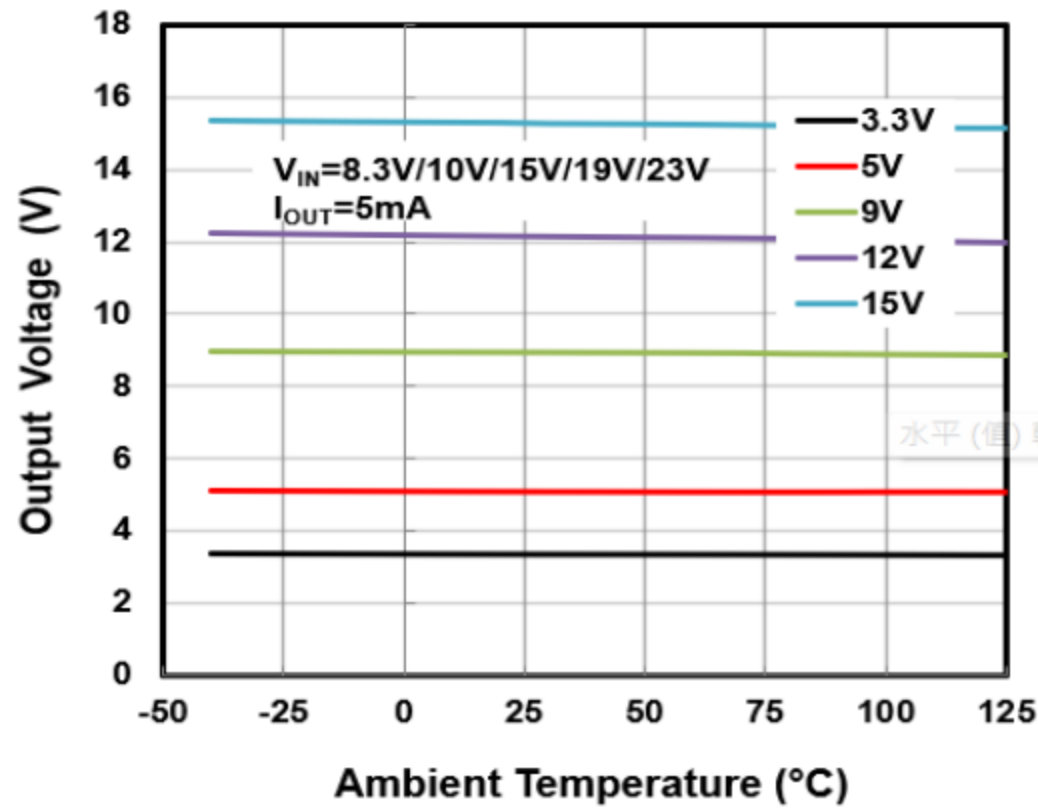

Fig 1. Output Voltage vs. Ambient Temperature

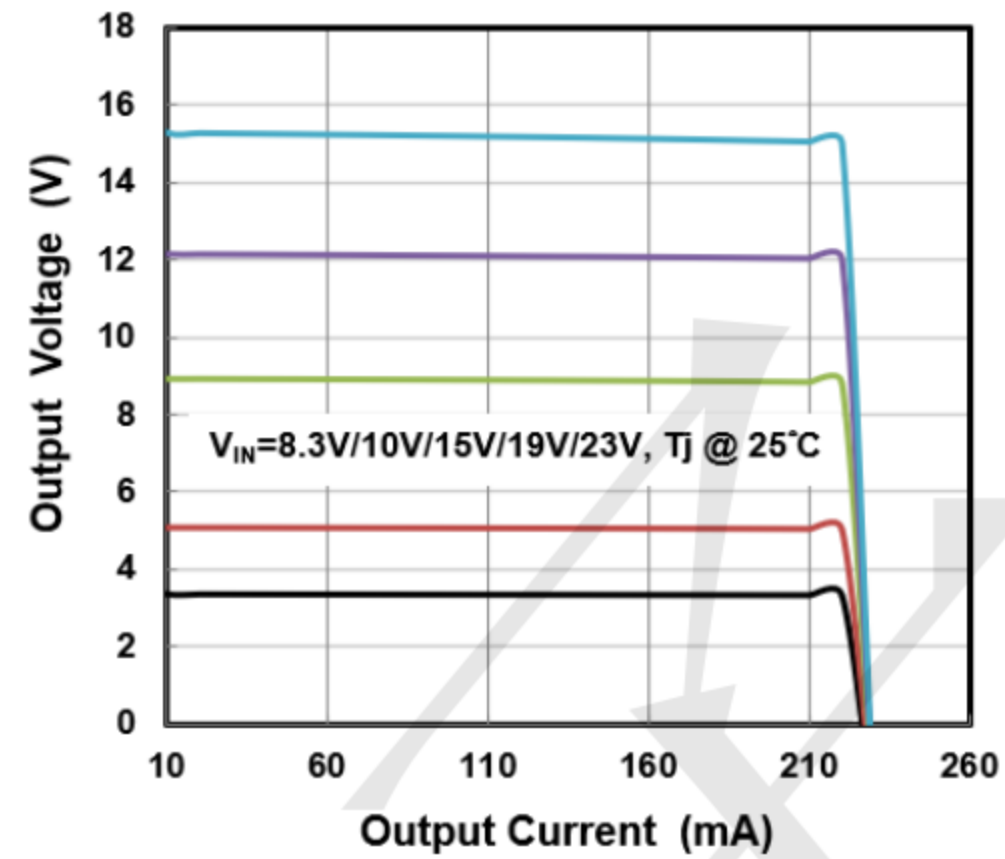

Fig 2. Output Voltage vs. Output Current

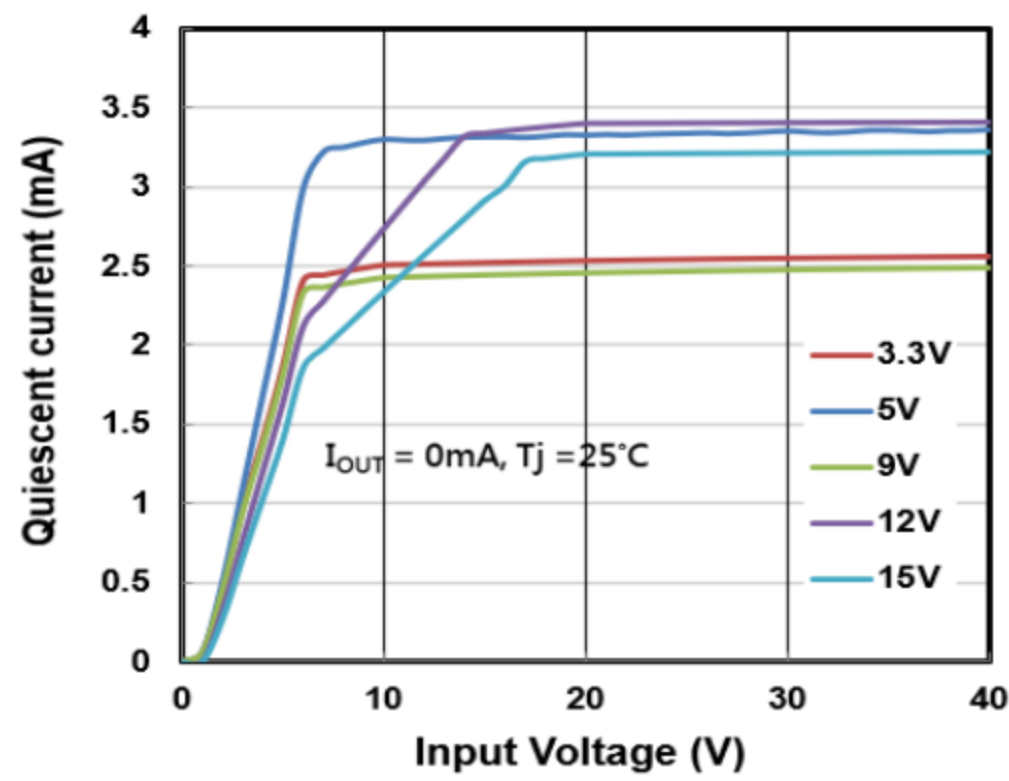

Fig 3. Quiescent Current vs. Input Current

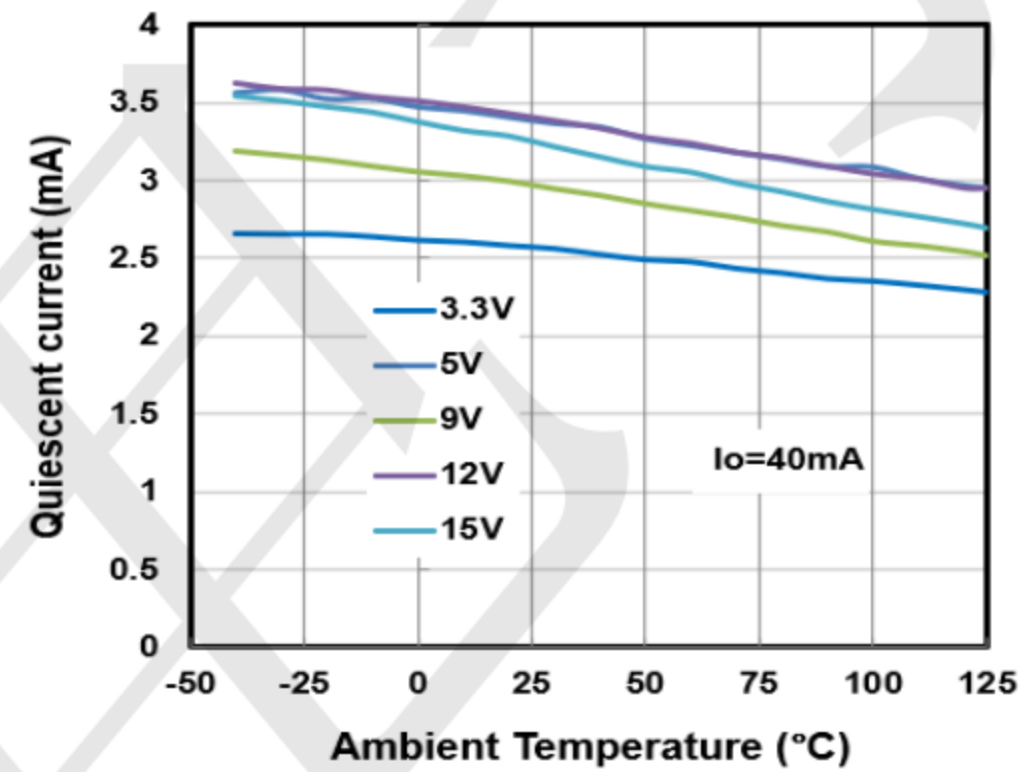

Fig 4. Quiescent Current vs. Temperature

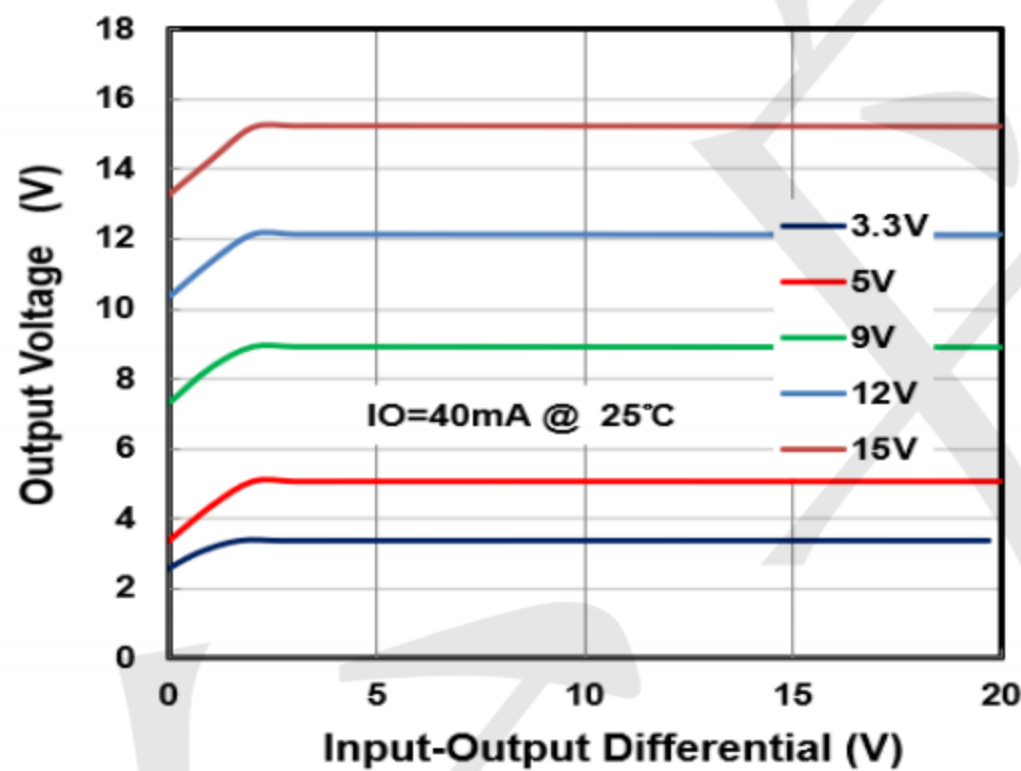

Fig 5. Output Voltage vs.  $V_{IN}-V_{OUT}$  Diff.



**TECH PUBLIC**

—台丹电子—

**LM3480 Series**

**100-mA, SOT-23, Quasi Low-Dropout Linear Voltage Regulator**

[www.sot23.com.tw](http://www.sot23.com.tw)

**Outline Drawing - SOT23**

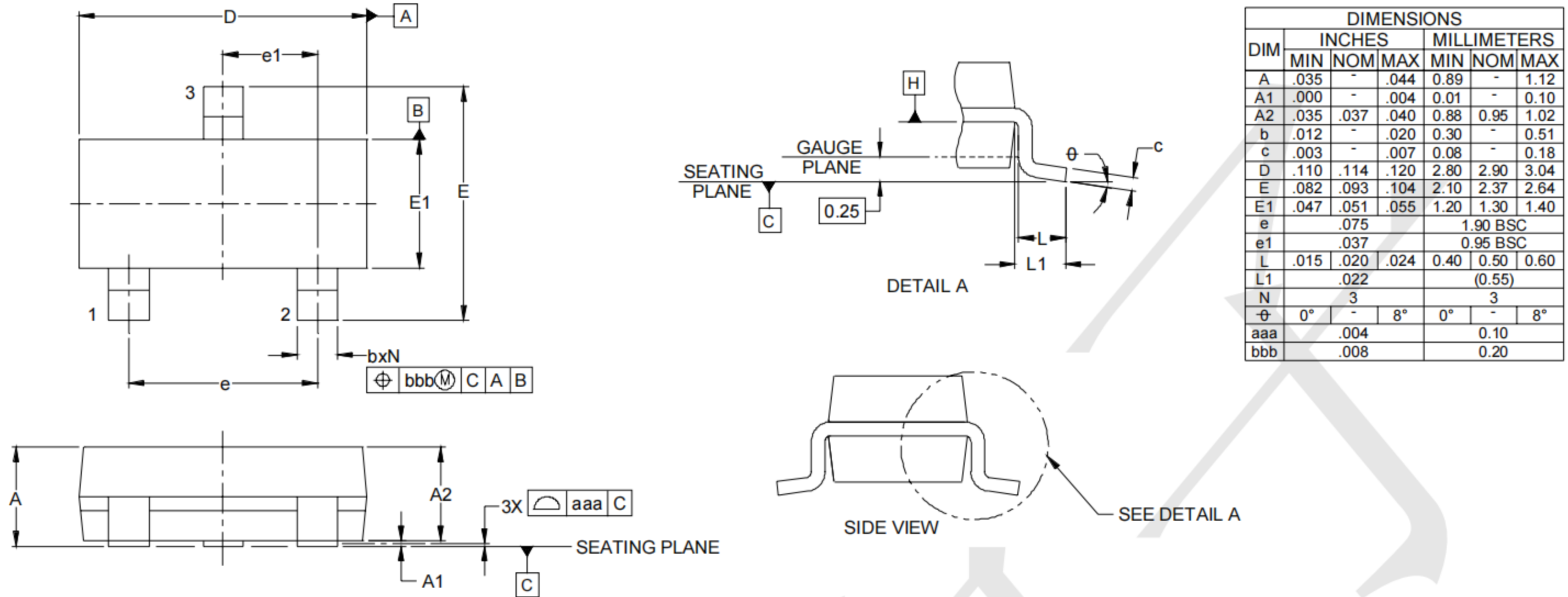

**Land Pattern - SOT23**

