

修订 REV AO	标记 MARK	修改摘要 REVISION DESCRIPTION	签名 SIGNATURE	日期 DATE
		NEW DWG		2016-03-12

测试条件:

- a. 100%短/断路测试。
- b. DC:300V AC:200V 绝缘阻抗:10MΩ
- c. 导通阻抗:≤5Ω
- d. 实机8K*4K 60HZ视音频测试。

HDMI接线表

P1		P2
1		1
3		3
2		2
4		4
6		6
5		5
7		7
9		9
8		8
10		10
12		12
11		11
14		14
19		19
17		17
13		13
15		15
16		16
18		18
外壳		外壳

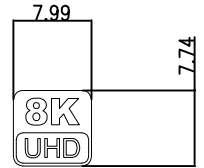
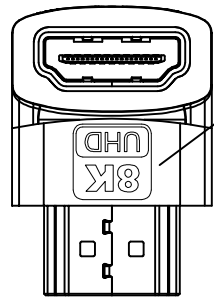
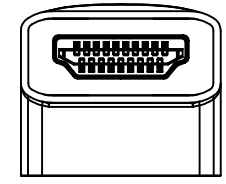
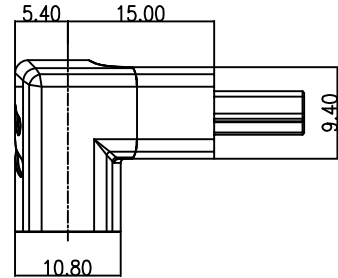
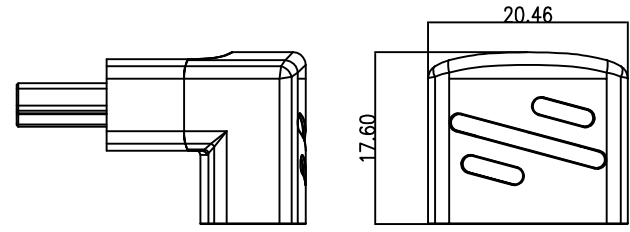
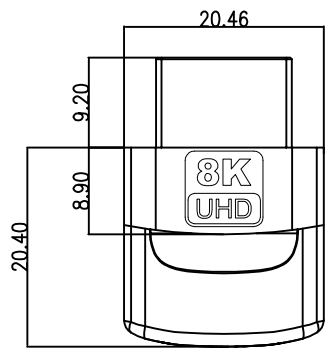



铝壳

项目	材料	规格	单位	用量
7	包装	自封口拉链PE胶袋	pcs	1
6	PVC胶料	45P 加州65 N18P 环保胶料	g	6
5	PE胶料	PE低密度PE内模胶料	g	3
4	铝壳	阳极一氧高光黑色铝壳9.4mm*8.9mm*20.46mm 镭雕LOGO	pcs	2
3	PCBA	四层PCBA线路板	pcs	1
2	插头	HDMI AM 铁壳镀金 端子3U 夹板式	pcs	1
1	插头	HDMI AF 铁壳镀金 端子3U 夹板式	PCS	1



深圳市华德共创科技有限公司
Shenzhen Huade co-create Technology Co.,LTD
电话: 0755-23304126 传真: 0755-29940187

-TOLERANCES- UNLESS OTHERWISE SPECIFIED 公差参数表		 	TITLE: 产品名称: 8K HDMI AM-AF转接头直弯 90°					
X.X	±0.30	X.X*	±3°	APPD: 核准:	PART NO: 产品编号: HDMI-GD-142PWB			
X.XX	±0.20	X.XX*	±2°	CHECK: 校对: 王建业	DATE	SCALE	UNIT	CODE NUMBER
X.XXX	±0.10	X.XXX*	±1°	DRAW: 绘图: 黄艳兰	2016-03-12	1:1	mm	A001

由 Autodesk 教育版产品制作

由 Autodesk 教育版产品制作