

修订	标记	修改摘要	签名	日期
REV NO	MARK	REVISION DESCRIPTION	SIGNATURE	DATE
		NEW DWG		2016-03-12

测试条件:

- a. 100%短/断路测试。
- b. DC:300V AC:200V 绝缘阻抗:10MΩ
- c. 导通阻抗:≤5Ω
- d. 实机8K\*4K 60HZ视音频测试。

### HDMI接线表

P1		P2
1		1
3		3
2		2
4		4
6		6
5		5
7		7
9		9
8		8
10		10
12		12
11		11
14		14
19		19
17		17
13		13
15		15
16		16
18		18
外壳		外壳

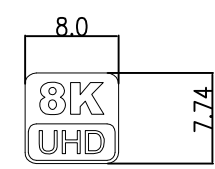
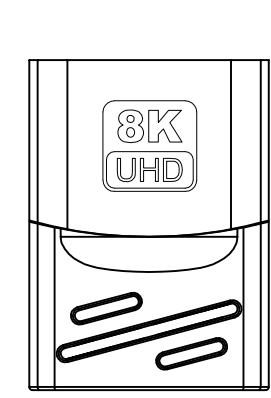
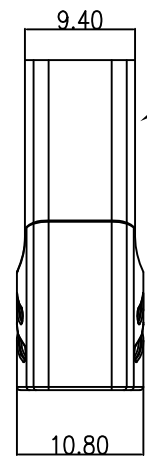
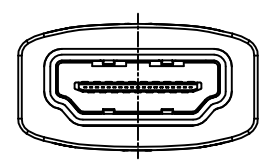
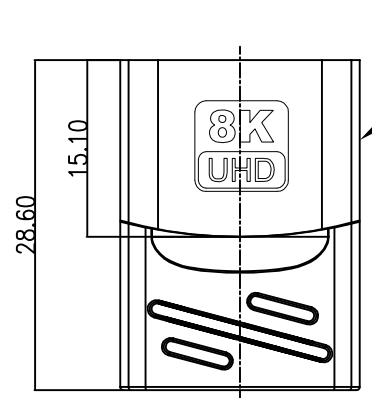
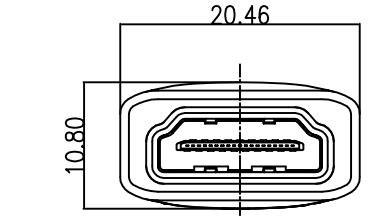

铝壳

铝壳

铝壳

项目	材料	规格	单位	用量
6	包装	自封口拉链PE胶袋	pcs	1
5	PVC胶料	45P 加州65 N18P 环保胶料	g	6
4	PE胶料	PE低密度PE内模胶料	g	3
3	铝壳	阳极一氧高光黑色铝壳10.8mm*15.1mm*20.46mm 镭雕LOGO	pcs	2
2	PCBA	四层PCBA线路板	pcs	1
1	插头	HDMI AF 铁壳镀金 端子3U 夹板式	PCS	2



深圳市华德共创科技有限公司  
Shenzhen Huade co-create Technology Co.,LTD  
电话: 0755-23304126 传真: 0755-29940187

TITLE: 8K HDMI AF-AF转接头  
产品名称: 8K HDMI AF-AF转接头

PART NO: HDMI-GD-141PWB  
产品编号: HDMI-GD-141PWB

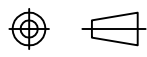
-TOLERANCES- UNLESS OTHERWISE SPECIFIED 公差参数表						
X.X	±0.30	X.X*	±3°	APPD: 核准:		
X.XX	±0.20	X.XX*	±2°	CHECK: 校对: 王建业	DATE	SCALE
X.XXX	±0.10	X.XXX*	±1°	DRAW: 绘图: 黄艳兰	2016-03-12	1:1
				UNIT	mm	CODE NUMBER
				A001		

由 Autodesk 教育版产品制作

由 Autodesk 教育版产品制作