

Planar Plastic Zener Diode

Version: A3 2021-10-20

Features

- 500mW Rating on FR-4 or FR-5 Board
- Wide Zener Reverse Voltage Range – 2.4 V to 75V
- Package Designed for Optimal Automated Board Assembly
- Small Package Size for High Density Applications
- General Purpose, Medium Current
- ESD Rating of Class 3 (>16 kV) per Human Body Model
- Tolerance approximately: $\pm 5\%$
- Device meets MSL 1 requirements

Exterior

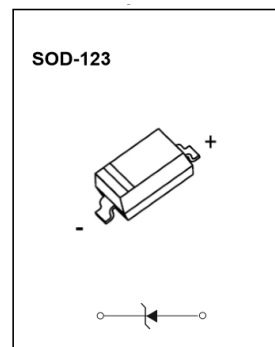

Application Information

- Cellular handsets
- Tablets
- Other portable devices

Package (top view)



Agency Approvals

Icon	Description
RoHS	Compliance with 2011/65/EU
HF	Compliance with IEC61249-2-21:2003
	Mean lead free

Schematic(top view)



Maximum Ratings(Ta=25°C unless otherwise specified)

Parameters	Symbol	MAX	Unit
Forward Voltage @IF=10mA	VF	0.9	V
Power Dissipation	Pd	500	mW
Thermal Resistance, Junction-to-Ambient (Note 2)	R _{θJA}	340	°C/W
Thermal Resistance, Junction-to-Lead (Note 2)	R _{θJA}	150	°C/W
Junction and Storage Temperature Range	Tj, Tstg	-65 to +150	°C

Maximum ratings are those values beyond which device damage can occur. Maximum ratings applied to the device are individual stress limit values (not normal operating conditions) and are not valid simultaneously. If these limits are exceeded, device functional operation is not implied, damage may occur and reliability may be affected.

Notes: 1. FR-5 = 3.5 X 1.5 inches, using the minimum recommended footprint.

2. Thermal Resistance measurement obtained via infrared Scan Method

Planar Plastic Zener Diode

Version: A3 2021-10-20

Part Number and Electrical Parameter

Part Number	Device Marking	Zener Voltage(Note3 and 4)				Zener Impedance(Note 5)			Maximum Reverse Current	
		VZ@I _{ZT}			I _{ZT}	Z _{ZT} @I _{ZT}	Z _{ZK} @I _{ZK}	I _{ZK}	I _R	V _R
		Nom(V)	Min(V)	Max(V)	(mA)	(Ω)		(mA)	(μA)	(V)
BW-D1G2V4T1G-5	C1	2.4	2.28	2.52	20	30	1200	0.25	100	1.0
BW-D1G2V5T1G-5	C2	2.5	2.38	2.63	20	30	1250	0.25	100	1.0
BW-D1G2V7T1G-5	C3	2.7	2.57	2.84	20	30	1300	0.25	75	1.0
BW-D1G2V8T1G-5	C4	2.8	2.66	2.94	20	30	1400	0.25	75	1.0
BW-D1G3V0T1G-5	C5	3.0	2.85	3.15	20	30	1600	0.25	50	1.0
BW-D1G3V3T1G-5	G1	3.3	3.14	3.47	20	28	1600	0.25	25	1.0
BW-D1G3V6T1G-5	G2	3.6	3.42	3.78	20	24	1700	0.25	15	1.0
BW-D1G3V9T1G-5	G3	3.9	3.71	4.10	20	23	1900	0.25	10	1.0
BW-D1G4V3T1G-5	G4	4.3	4.09	4.52	20	22	2000	0.25	5	1.0
BW-D1G4V7T1G-5	G5	4.7	4.47	4.94	20	19	1900	0.25	5	2.0
BW-D1G5V1T1G-5	E1	5.1	4.85	5.36	20	17	1600	0.25	5	2.0
BW-D1G5V6T1G-5	E2	5.6	5.32	5.88	20	11	1600	0.25	5	3.0
BW-D1G6V0T1G-5	E3	6.0	5.70	6.30	20	7	1600	0.25	5	3.5
BW-D1G6V2T1G-5	E4	6.2	5.89	6.51	20	7	1000	0.25	5	4.0
BW-D1G6V8T1G-5	E5	6.8	6.46	7.14	20	5	750	0.25	3	5.0
BW-D1G7V5T1G-5	F1	7.5	7.13	7.88	20	6	500	0.25	3	6.0
BW-D1G8V2T1G-5	F2	8.2	7.79	8.61	20	8	500	0.25	3	6.5
BW-D1G8V7T1G-5	F3	8.7	8.27	9.14	20	8	600	0.25	3	6.5
BW-D1G9V1T1G-5	F4	9.1	8.65	9.56	20	10	600	0.25	3	7.0
BW-D1G10VT1G-5	F5	10	9.50	10.50	20	17	600	0.25	3	8.0
BW-D1G11VT1G-5	H1	11	10.45	11.55	20	22	600	0.25	2.0	8.4
BW-D1G12VT1G-5	H2	12	11.40	12.60	20	30	600	0.25	1.0	9.1
BW-D1G13VT1G-5	H3	13	12.35	13.65	9.5	13	600	0.25	0.5	9.9
BW-D1G14VT1G-5	H4	14	13.30	14.70	9.0	15	600	0.25	0.1	10
BW-D1G15VT1G-5	H5	15	14.25	15.75	8.5	16	600	0.25	0.1	11
BW-D1G16VT1G-5	J1	16	15.20	16.80	7.8	17	600	0.25	0.1	12
BW-D1G17VT1G-5	J2	17	16.15	17.85	7.5	19	600	0.25	0.1	13
BW-D1G18VT1G-5	J3	18	17.10	18.90	7.0	21	600	0.25	0.1	14
BW-D1G20VT1G-5	J5	20	19.00	21.00	6.2	25	600	0.25	0.1	15
BW-D1G22VT1G-5	K1	22	20.90	23.10	5.6	29	600	0.25	0.1	17
BW-D1G24VT1G-5	K2	24	22.80	25.20	5.2	33	600	0.25	0.1	18
BW-D1G25VT1G-5	K3	25	23.75	26.25	5.0	35	600	0.25	0.1	19
BW-D1G27VT1G-5	K4	27	25.65	28.35	5.0	41	600	0.25	0.1	21
BW-D1G28VT1G-5	K5	28	26.60	29.40	4.5	44	600	0.25	0.1	21
BW-D1G30VT1G-5	M1	30	28.50	31.50	4.2	49	600	0.25	0.1	23
BW-D1G33VT1G-5	M2	33	31.35	34.65	3.8	58	700	0.25	0.1	25
BW-D1G36VT1G-5	M3	36	34.20	37.80	3.4	70	700	0.25	0.1	27

BW-D1G39VT1G-5	M4	39	37.05	40.95	3.2	80	800	0.25	0.1	30
BW-D1G43VT1G-5	M5	43	40.85	45.15	3.0	93	900	0.25	0.1	33
BW-D1G47VT1G-5	N1	47	44.65	49.35	2.7	105	1000	0.25	0.1	36
BW-D1G51VT1G-5	N2	51	48.45	53.55	2.5	125	1100	0.25	0.1	39
BW-D1G56VT1G-5	N3	56	53.20	58.80	2.2	150	1300	0.25	0.1	43
BW-D1G60VT1G-5	N4	60	57.00	63.00	2.1	170	1400	0.25	0.1	46
BW-D1G62VT1G-5	N5	62	58.90	65.10	2.0	185	1400	0.25	0.1	47
BW-D1G68VT1G-5	P1	68	64.60	71.40	1.8	230	1600	0.25	0.1	52
BW-D1G75VT1G-5	P2	75	71.25	78.75	1.7	270	1700	0.25	0.1	56

Notes:

- The type numbers shown have a standard tolerance of $\pm 5\%$ on the nominal Zener voltage.
- Nominal Zener voltage is measured with the device junction in thermal equilibrium at $T_L = 30^\circ\text{C} \pm 1^\circ\text{C}$.
- ZZT and ZZK are measured by dividing the AC voltage drop across the device by the ac current applied. The specified limits are for $I_Z(\text{AC}) = 0.1 I_Z(\text{dc})$ with the AC frequency = 1 KHz.

Part Numbering System

Mark

BW D1 G XXX T1 G 5
 (1) (2) (3) (4) (5) (6) (7)

- Bencent Zener Diode
- Package: SOD-123
- Power Dissipation: 500mW
- Work Voltage: 2.4V-75V
- Package type: Taping, 3K/R
- Green
- Tolerance of accuracy: $\pm 5\%$



XX = Device Code
 M = Data Code

Typical Characteristics

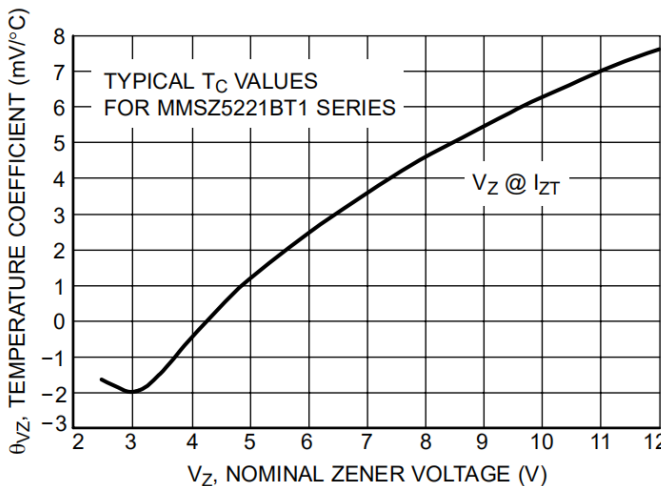

Figure 1. Temperature Coefficients
 (Temperature Range -55°C to $+150^\circ\text{C}$)

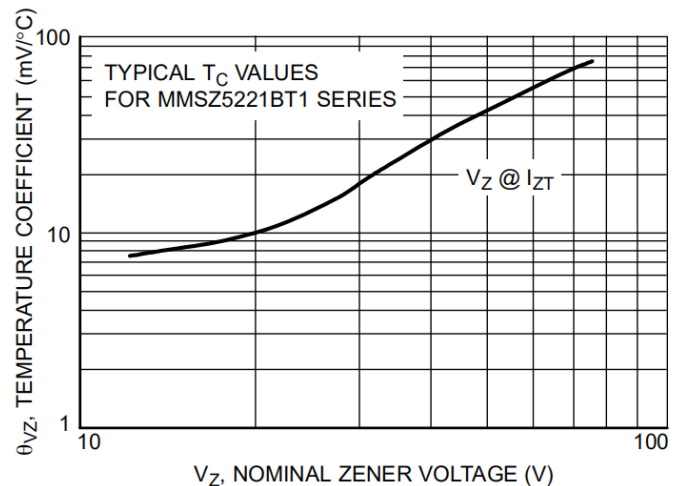

Figure 2. Temperature Coefficients
 (Temperature Range -55°C to $+150^\circ\text{C}$)

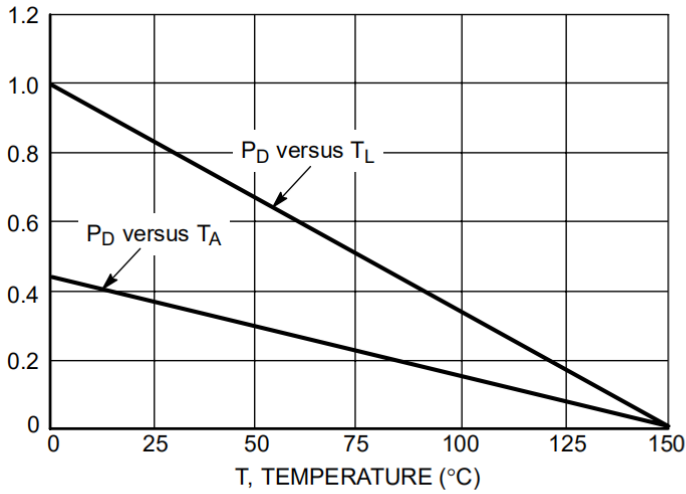

Figure 3. Steady State Power Derating

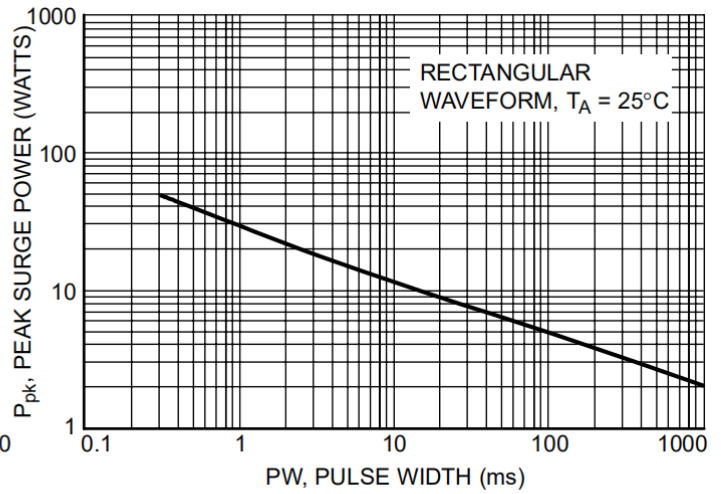

Figure 4. Maximum Nonrepetitive Surge Power

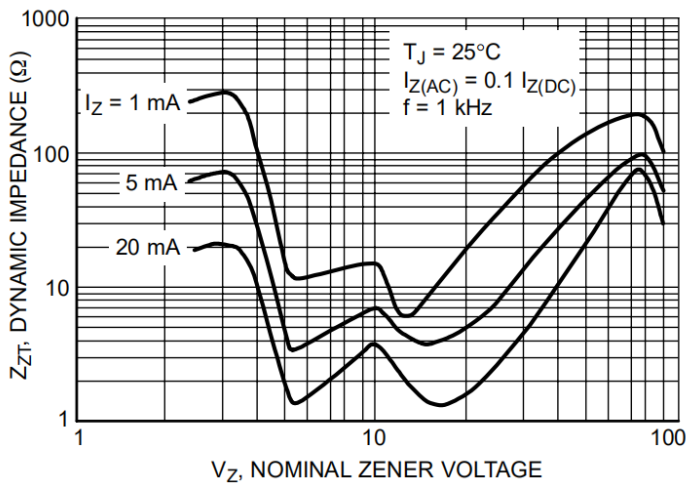

Figure 5. Effect of Zener Voltage on Zener Impedance

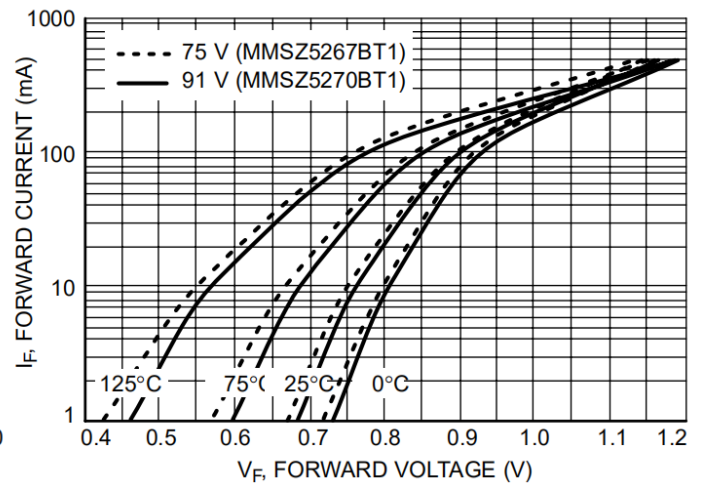

Figure 6. Typical Forward Voltage

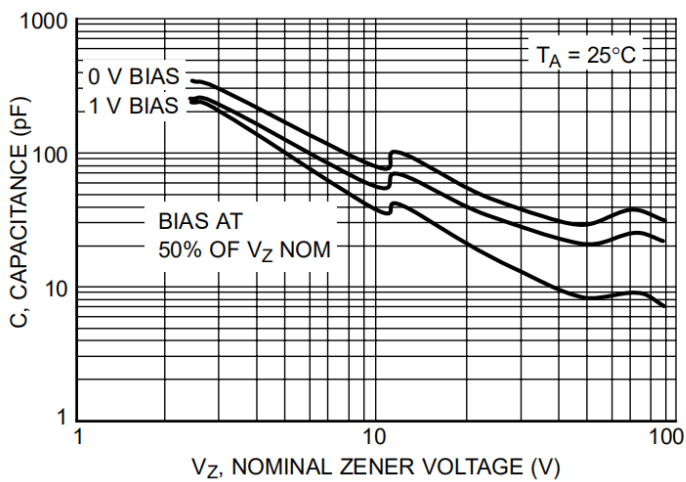

Figure 7. Typical Capacitance

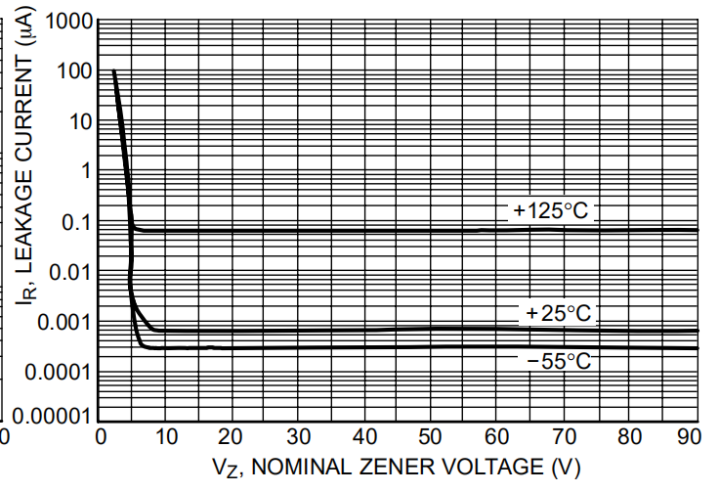

Figure 8. Typical Leakage Current

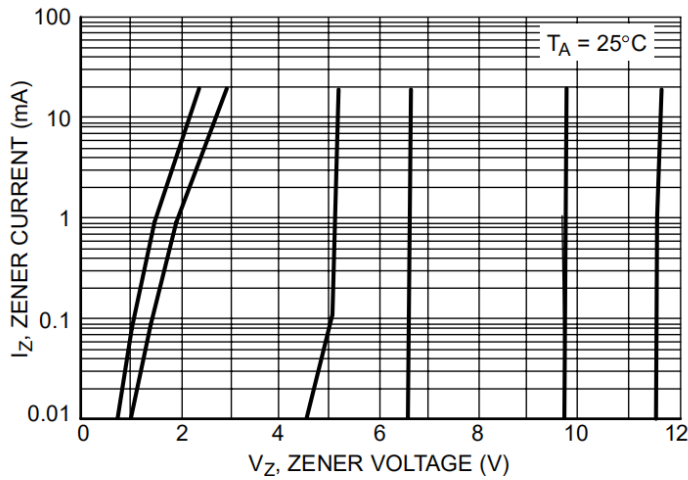

Figure 9. Zener Voltage versus Zener Current (V_Z Up to 12 V)

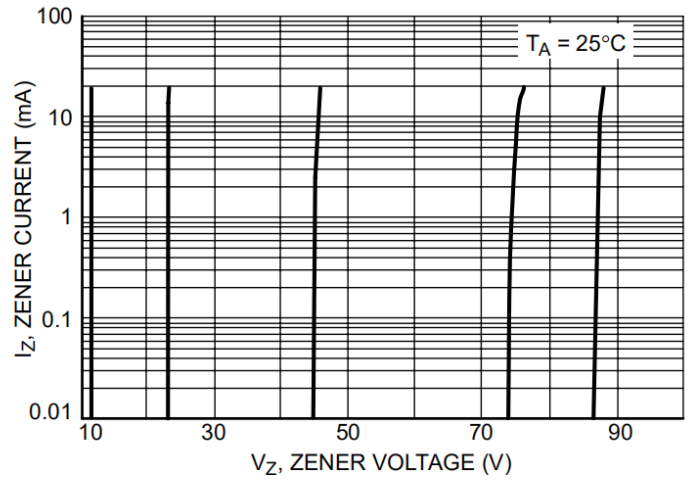
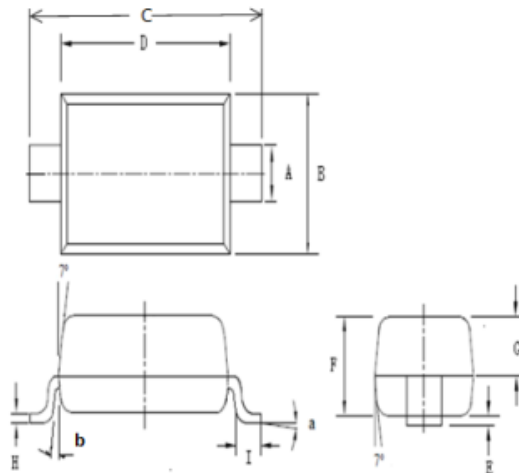

Figure 10. Zener Voltage versus Zener Current (12 V to 91 V)

Product Dimensions



SOD123

REF	mm	inch
A	0.45~0.65	0.018~0.026
B	1.40~1.70	0.055~0.067
C	3.55~3.85	0.140~0.152
D	2.55~2.85	0.100~0.112
E	0.00~0.10	0.000~0.004
F	1.20max	0.047max
G	0.60~0.70	0.024~0.028
H	0.075~0.125	0.003~0.005
I	0.25~0.45	0.010~0.018
a	0°~6°	
b	0.4°~0.8°	

SOD-123 Suggested Pad Layout

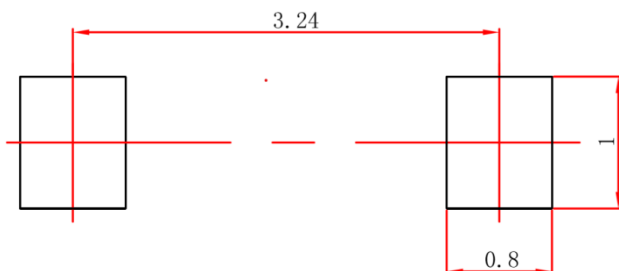

Notes:

1. Controlling dimension: in millimeters.
2. General tolerance: ± 0.05 mm.
3. The pad layout is for reference purpose only.

Planar Plastic Zener Diode

Version: A3 2021-10-20

Reflow Profile

Reflow Condition		Pb-Free assembly
Pre Heat	Temperature Min	150°C
	Temperature Max	200°C
	Time (min to max)	60 – 180 secs
Average ramp up rate (Liquid) Tamp (T _L) to peal		3°C/s max
T _S (max) to T _L - Ramp-up Rate		3°C/s max
Reflow	- Temperature (T _L) (Liquid)	217°C
	- Temperature (T _L)	60 – 150 secs
Peak Temperature (T _P)		260±0/-5 °C
Time within 5°C of actual peak Temperature (T _P)		30secs
Ramp-down Rate		6°C/s max
Time 25°C to peak Temperature (T _P)		8 mins max.
Do not exceed		260°C

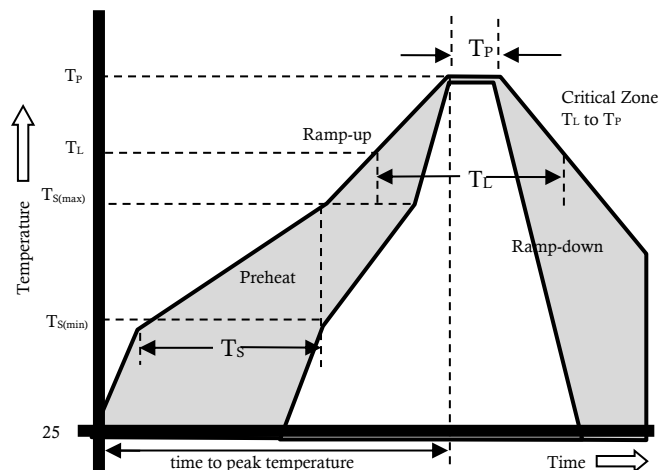

Package Reel Information

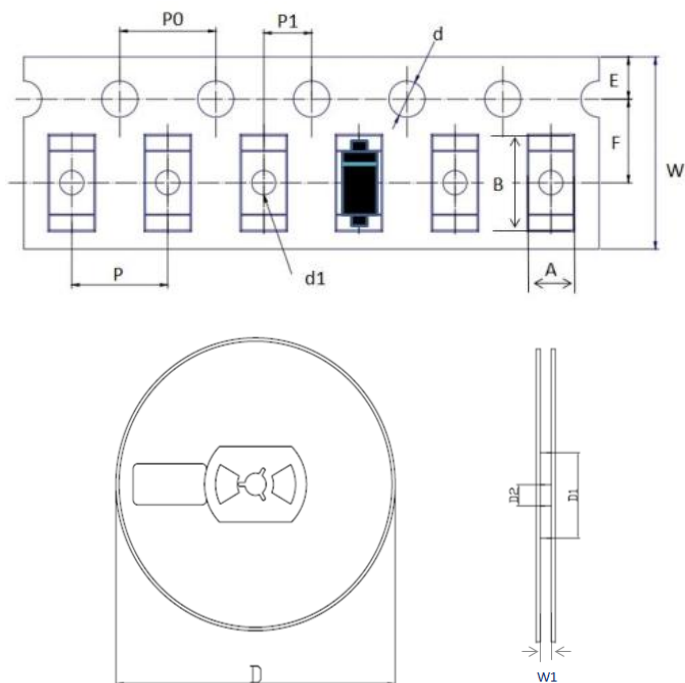

REF	mm	inch
A	1.90±0.20	0.075±0.008
B	4.10±0.20	0.161±0.008
d	1.50±0.1/-0	0.059±0.004/-0
d1	1.10±0.10	0.043±0.004
D	178.00±2.00	7.008±0.079
D1	55.00±3.00	2.165±0.118
D2	13.00±0.50	0.512±0.020
E	1.75±0.10	0.069±0.004
F	3.50±0.20	0.138±0.008
P	4.00±0.20	0.157±0.008
P0	4.00±0.20	0.157±0.008
P1	2.00±0.20	0.079±0.008
W	8.00±0.20	0.315±0.008
W1	9.50±1.00	0.374±0.039

OUTLINE	REEL (PCS)	PER CARTON (PCS)	REEL DIAMETERS (mm)	CARTON SIZE(mm)		
				L	W	H
TAPING	3,000	90,000	178	390	370	220