

Transient Voltage Suppressor

Features

- IEC61000-4-2 (ESD) ±15KV (air),±8KV (contact)
- IEC61000-4-5 (Lightning) 11A (8/20uS)
- IEC61000-4-4 (EFT) 40A (5/50nS)
- 352 Watts peak pulse power per Line (tp=8/20μ S)
- Low clamping voltage
- Weight 8 mg (Approximate)
- Moisture sensitivity level: Level 1

Exterior

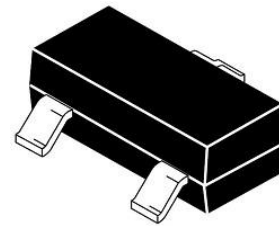

SOT-23

Application Information

- Microprocessor based equipment
- Personal Digital Assistants (PDA's)
- Notebooks, Desktops, and Servers
- Portable Instrumentation
- Networking and Telecom
- Serial and Parallel Ports
- Peripherals

Package (top view)

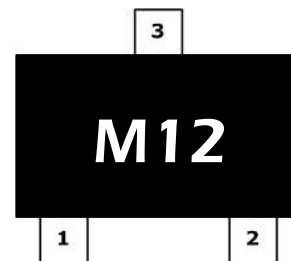

Agency Approvals

Icon	Description
RoHS	Compliance with 2011/65/EU
HF	Compliance with IEC61249-2-21:2003
	Mean lead free

Schematic

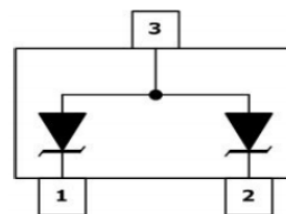

Part Number and Electrical Parameter

Part Number	$I_{DRM}@V_{DRM}$		$V_{BR}^{①}@I_R$		$V_C@I_{pp}^{②}$		$V_C@I_{pp}^{②}$		$C_o^{③}$
	μA	V	V	mA	V	A	V	A	pF
	MAX		MIN		MAX		MAX		MAX
BV-T312Z2B	1	12	13.3	1	22	1	32	11	130

Absolute maximum ratings measured at $T_A = 25^\circ C$ RH = 45%-75% (unless otherwise noted).

- ① V_{BR} is measured at $I_R = 1mA$, Pin 1, 2 to 3
- ② Surge Waveform: 8/20μ S, Pin 1, 2 to 3
- ③ Off-state capacitance is measured in $V_{DC} = 0V, V_{RMS} = 1V, f = 1MHz$.

Transient Voltage Suppressor

Part Numbering System

BV T3 12 Z 2 B
(1) (2) (3) (4) (5) (6)

- (1) Bencent Transient Voltage Suppressor
- (2) Package: SOT23
- (3) Stand-off Voltage: 12V
- (4) Normal Capacitance
- (5) 2 Lines protection (Polarity omitted)
- (6) Bencent internal code

Mark

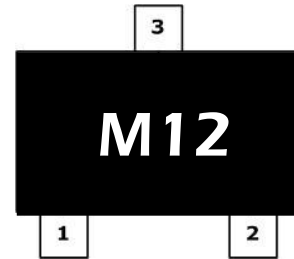

M12: Part Number

V-I Curve

Parameters	Definition
V_C	Clamping voltage
I_{PP}	Surge waveform 8/20 μ s
V_{DRM}	Stand-off Voltage
V_{BR}	Breakdown Voltage
I_{DRM}	Reverse Leakage Current
I_R	Test current
P_{pp}	Peak Pulse Power Dissipation

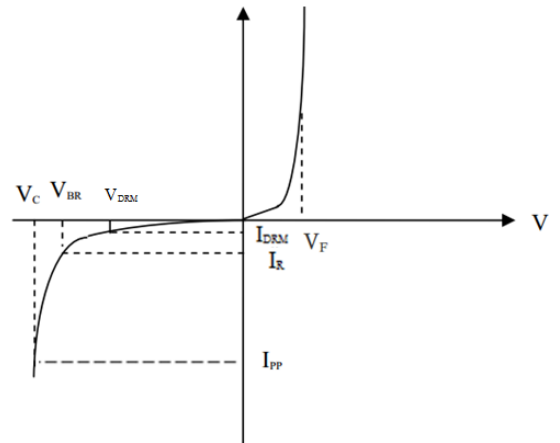

Thermal Considerations

symbol	Parameter	Value	Unit
T_J	Operating Junction Temperature Range	-40 to +125	$^{\circ}C$
T_S	Storage Temperature Range	-55 to +150	$^{\circ}C$

Typical Characteristics

Figure 1. Power Detating

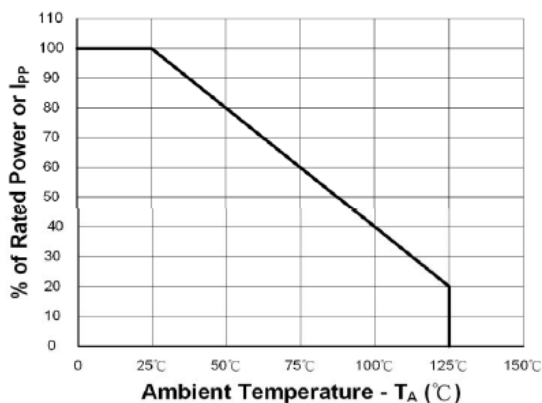

Clamping Voltage Vs. Peak Pulse Current

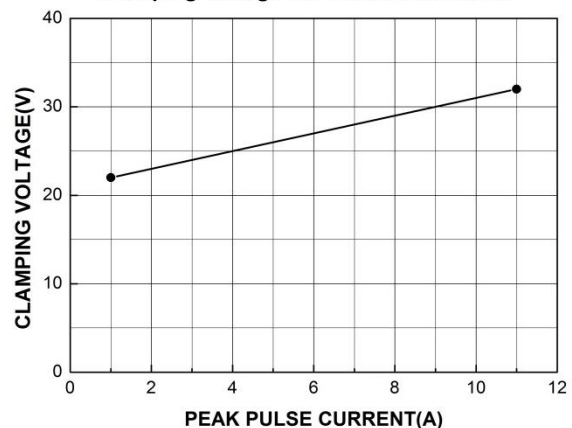

Transient Voltage Suppressor

Version: A0 2017-05-23

Environmental Characteristics

Testing items	Technical standards
High temperature Reverse Bias Test	Temperature: $125\pm 3^{\circ}\text{C}$ Bias= $80\%V_{\text{DRM}}$ Time: 168H
High Temperature Life Test	Temperature: 150°C Time: 168H
High-low Temperature Cycle test	Temperature: From -40°C to 125°C Dwell time: 30min, 10cycles
High Temperature & High Humidity Test	Temperature: 85°C Humidity: 85% Time: 168H
Pressure cooker Test	Temperature: 121°C , 2atm. Humidity: 100% Time: 24H
Resistance of soldering heat	Temperature: $260\pm 5^{\circ}\text{C}$ Time of dip soldering: 10s, 3times

Note: The above testing items can be specified by customer's special request

Product Dimensions

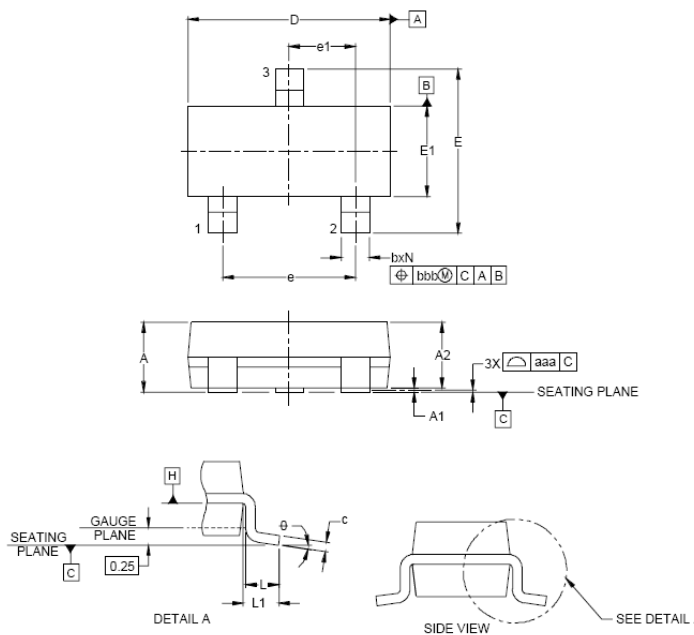

REF	mm	inch
A	0.9~1.12	0.035~0.044
A1	0.1 max	0.004 max
A2	0.88~1.02	0.035~0.040
b	0.3~0.5	0.012~0.02
c	0.08~0.18	0.003~0.007
D	2.8~3.0	0.11~0.118
E	2.25~2.55	0.089~0.1
E1	1.2~1.4	0.047~0.055
L	0.3~0.5	0.012~0.02
L1	0.5~0.6	0.02~0.024
e	1.9	0.075
e1	0.95	0.037
θ	8 degree(Max)	

Recommended Soldering Pad

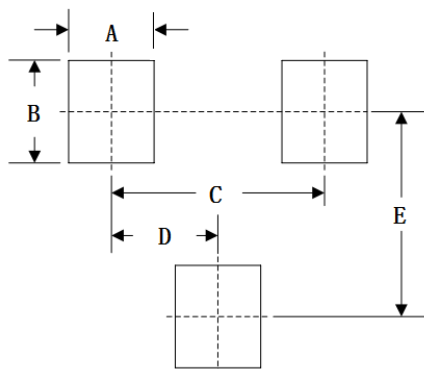

REF	mm	inch
A	0.8	0.031
B	0.9	1.535
C	1.9	0.075
D	0.95	0.037
E	1.8	0.071

Transient Voltage Suppressor

Reflow Profile

Reflow Condition		Pb-Free assembly
Pre Heat	Temperature Min	150°C
	Temperature Max	200°C
	Time (min to max)	60 – 180 secs
Average ramp up rate (Liquid) Tamp (T _L) to peak		3°C/s max
T _S (max) to T _L - Ramp-up Rate		3°C/s max
Reflow	- Temperature (T _L) (Liquid)	217°C
	- Temperature (T _L)	60 – 150 secs
Peak Temperature (T _P)		260±0/-5 °C
Time within 5°C of actual peak Temperature (T _P)		25secs
Ramp-down Rate		6°C/s max
Time 25°C to peak Temperature (T _P)		8 mins Max.
Do not exceed		260°C

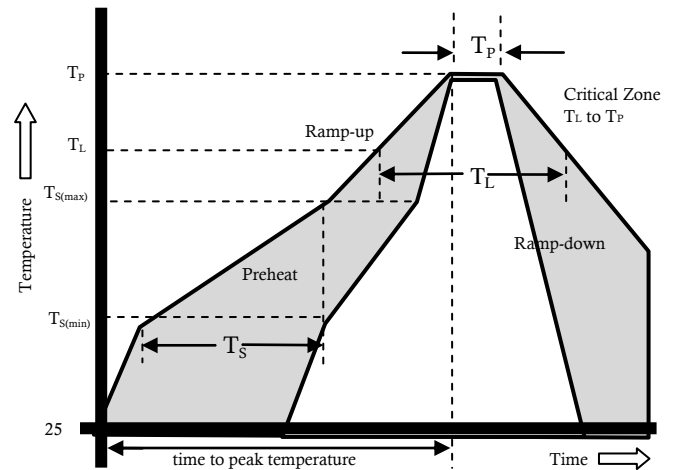

Package Reel Information

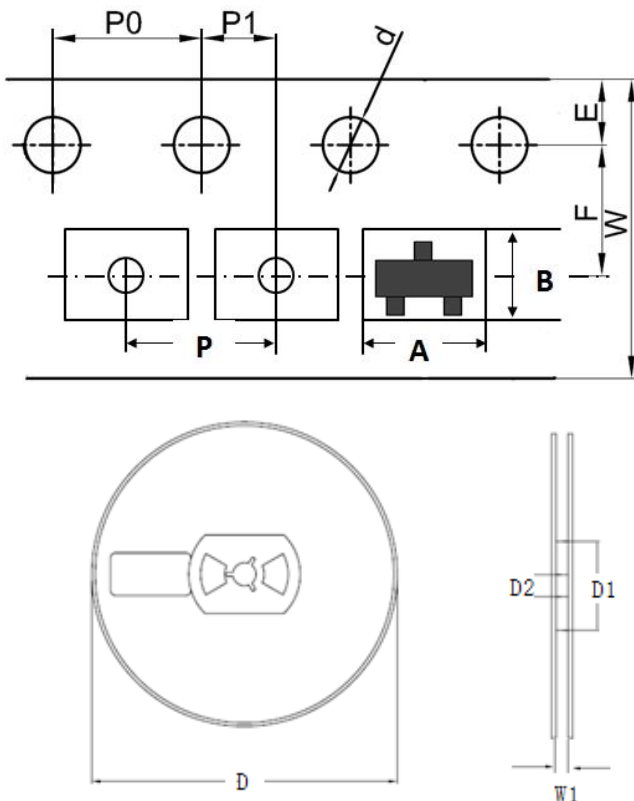

REF	mm	inch
A	3.10±0.2	0.122±0.008
B	2.9±0.2	0.114±0.008
d	1.5±0.1/-0	0.059±0.004/-0
D	178±2.0	7.008±0.079
D1	55±3	2.165±0.118
D2	13±0.5	0.512±0.020
E	1.75±0.1	0.069±0.004
F	3.5±0.2	0.138±0.008
P	4.0±0.2	0.158±0.008
P0	4.0±0.2	0.158±0.008
P1	2.0±0.2	0.079±0.008
W	8.0±0.2	0.315±0.008
W1	9.5±1	0.374±0.039

Outline	Reel (pcs)	Per Carton (pcs)	Reel Diameters (mm)	Carton Size(mm)		
				L	W	H
Taping	3,000	90,000	178	390	370	220