



**TROQ Electronic Co.,Ltd.**  
**CRYSTAL UNIT SPECIFICATIONS**

<b>Customer</b>	
<b>Production Name</b>	<b>OSC 3.2*2.5</b>
<b>Customer P/N</b>	<b>N/A</b>
<b>TROQ P/N</b>	<b>R050000054</b>
<b>Revision</b>	<b>A</b>
<b>Print Date</b>	<b>2023/5/11</b>

<b>Drawn</b>	<b>Checked</b>	<b>Approved</b>



RoHS Compliant

Pb used in sealing glass material is exempt from EU directive

● ELECTRICAL PARAMETERS

产品技术指标	Min	Max	Units
1.Holder Type	OSC 3.2*2.5		
2.Mode of Oscillation	Fundamental		
3.Frequency	50.000000		MHZ
4.Load Capacitance (CL)	15		pF
5.Frequency Tolerance	-10	10	ppm
6.Operating Temperature Range	-40	85	°C
7.Storage Temperature Range	-55	125	°C
8.Supply Voltage(VDD)	1.8-3.3		V
9.“0”Level (VOL)		VDD×0.1	V
10.“1”Level(VOH)	VDD×0.9		V
11.Enable High Voltage(ELH)	VDD×0.7		V
12.Enable Low Voltage(ELL)		VDD×0.3	V
13.Symmetry of Wave From(Symmetry)	45-55		%
14.Current Consumption(IDD)		10.0	m A
15.Rise and Fall Time(Tr,Tf)		5.0	nSec
16.Start time(tosc)		10.0	mSec
17.Aging	± 3		ppm/year
18.Output waveform	CMOS		
19.Other	Moisture Sensitivity Level (零件湿敏等级) Level 1		

OUTLINE DIMENSIONS(UNIT:mm) 外形尺寸 (单位: mm)

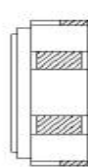
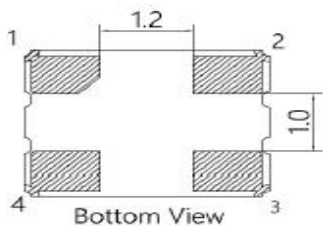
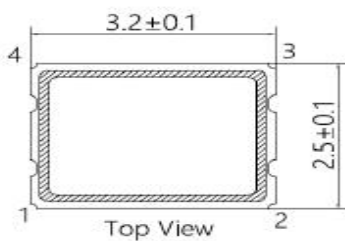

PAD FUNCTION  
 1: ENABLE CONTROL  
 2: GND  
 3: OUT  
 4: VDD

Enable Control

Pad 1 Input	Pad 3 Output
Level High or Open	Normal Operation
Level Low	Stopped

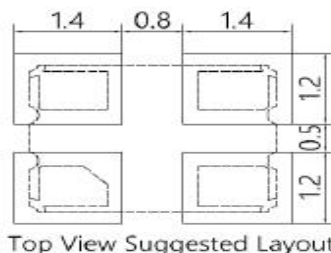

● **Marking (标记)**

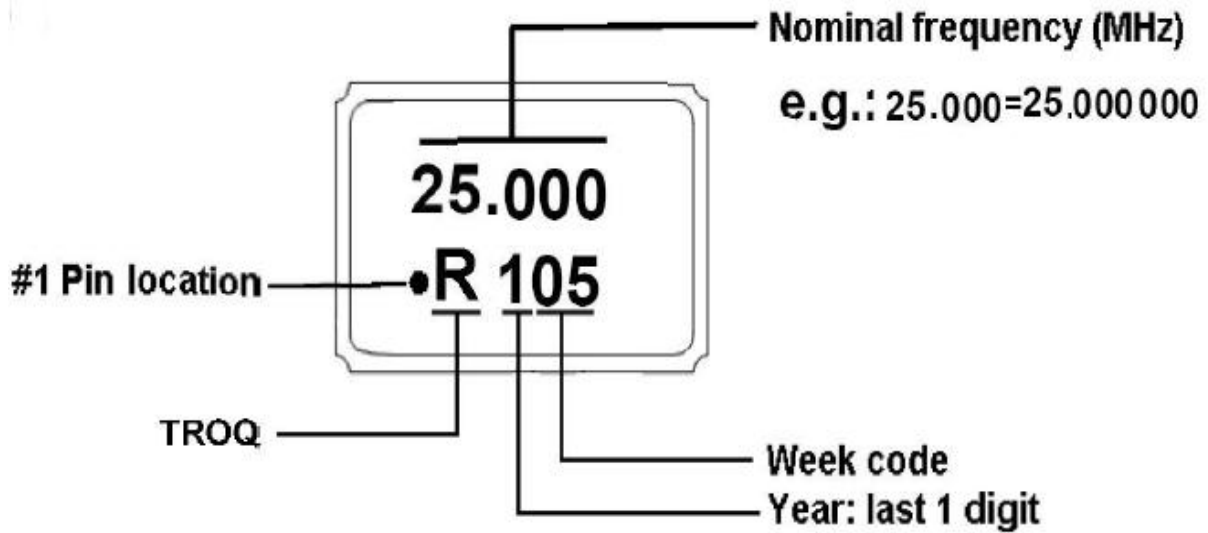

● **SUGGESTED REFLOW PROFILE** (回流焊曲线图)

**Total time:200sec.Max.** (总时间: 200秒 最大)

**Solder melting point:220°C** (熔点220 °C)

Profiles Feature (特性)		Pb-Free Assembly
Average Ramp-up Rate(Ts max to Tp)	平均升温速度	3°C/second Max
Preheat	预热	
■ Temperature Min (Ts min)	最低温度	125°C
■ Temperature Max (Ts max)	最高温度	200°C
■ Time (ts min to ts max )	从最低到最高时间	(60~180) seconds
Time maintained above	维持上述时间	
■ Temperature(T1)	温度	217°C
■ Time(tp)	时间	(60~150) seconds
Peak/Classification Temperature(Tp)	最高点温度	260 °C
Time within 5°C of actual Peak Temperature(tp)	高温维持时间	(20~40) seconds
Ramp-down rate	降温速度	6°C/second max
Time 25°C to Peak Temperature	从25°C到最高温度的时间	8 minutes max
Suggest reflow times	建议 reflow次数	3 Times max

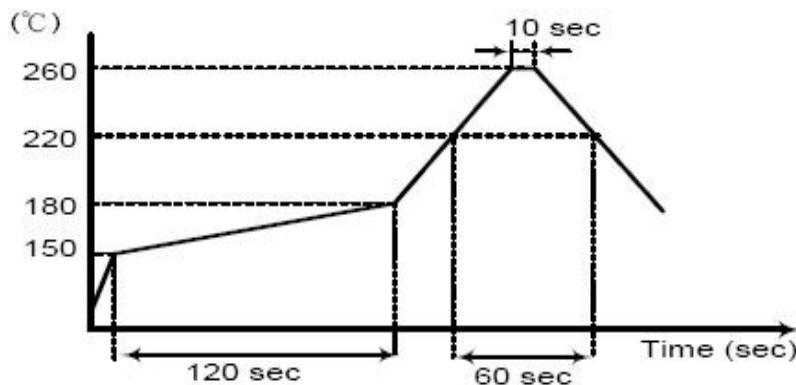

- PACKING (包装) 3Kpcs/REEL

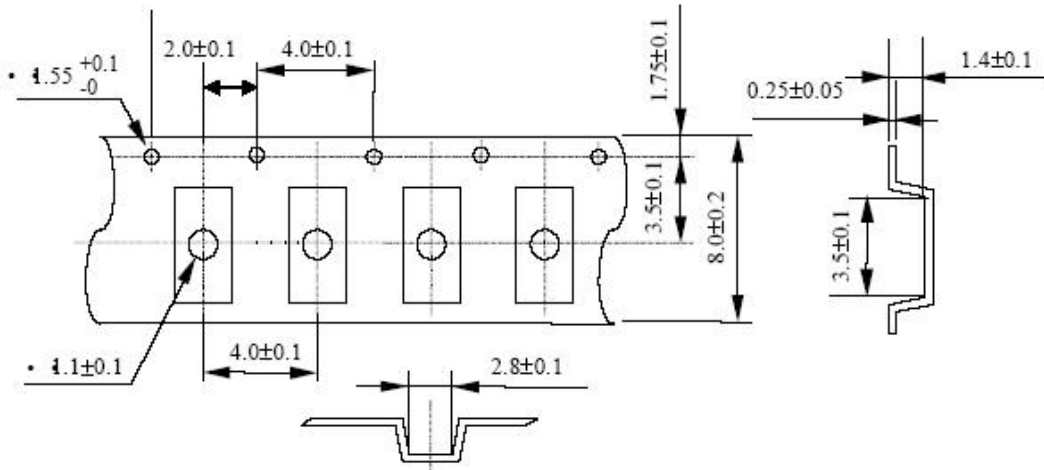

[Size in mm]

8.3. Reel dimension & Outline drawing

Material of the Reel : PS

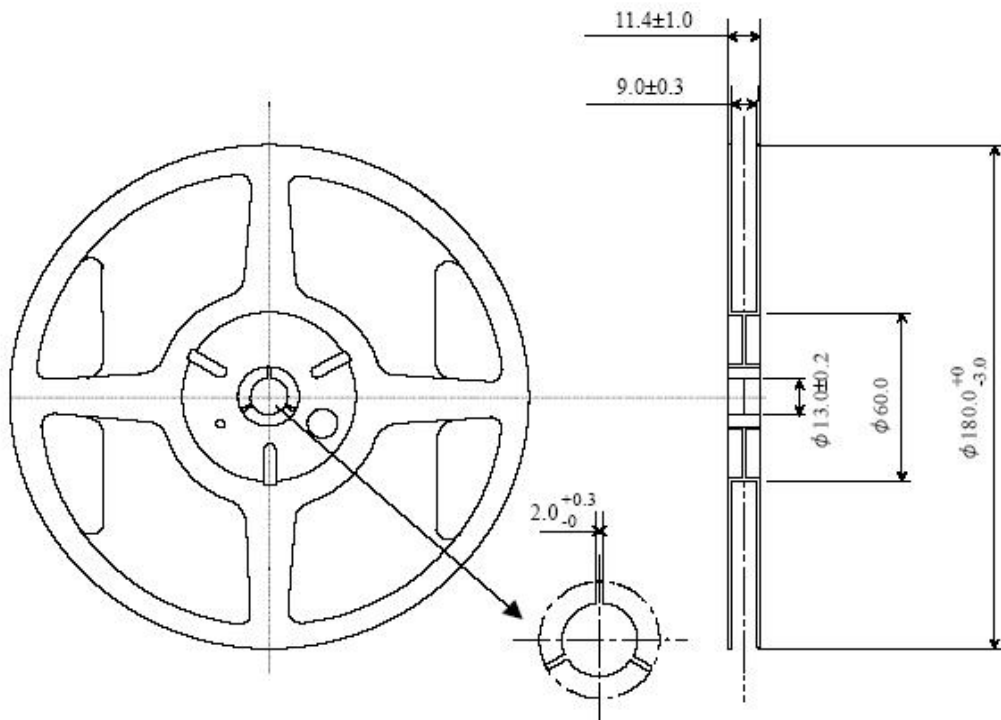

● RELIABILITY SPECIFICATIONS (信赖度试验)

No	Test Item (测试项目)	Test Conditions (测试条件)	Reference (参考)
1	High Temperature High Humidity Storage (高温、高湿、储存)	Temperature: 85°C±3°C 温度: 85°C±3°C Relative Humidity:85%RH 相对湿度: 85%RH Time: 96 Hours 时间: 96小时	JIS C5023
2	High Temperature Storage (高温储存)	Temperature: 125°C±3°C 温度:125°C ±3°C Time: 96 Hours 时间:96 小时	MIL-STD-883E Method 1005.8
3	Low Temperature Storage (低温储存)	Temperature: -40°C ±3°C 温度: -40°C ±3°C Time: 96Hours 时间: 96小时	MIL-STD-883E Method 1013
4	Thermal Shock (温度冲击)	Temperature1:-55°C ±5°C 温度1:-55°C ±5°C Temperature2:85°C ±5 °C 温度2: 85°C ±5 °C Temperature change between T1 and T2 5 min T1和T2温度在5分钟内改变 10cycles maintain T1 and T2 for 30 minutes each mone cycle 每次循环30分钟共10次	MIL-STD-202F Method 107 Condition A
5	RESISTANCE TO SOLDER HEAT (耐焊接热)	Solder Temperature: 260°C ±5°C 焊槽温度:260°C ±5°C Time: 10±1 Seconds 时间: 10±1秒	MIL-STD-202F Method 210E
6	Solderability(可焊性)	The solder pot temperature is 245±5°C , dwell time 5±0.5 245±5°C 焊锡槽浸润5±0.5秒	J-STD-002B
7	Drop Test (落下试验)	3 Times Free Fall from 75cm height table to 3cm thickness hard wood board 从75cm高度3次跌落到3cm厚硬质木板上	JIS C6701
8	MECHANICAL SHOCK (机械冲击)	Half sine wave,1000 G 半正弦波,加速度1000G 3 Times for all 3 directions X、Y、Z 三个相互垂直方向各三次	MIL-STD-202F Method 213B
9	Vibration (机械振动)	Frequency Range: 10Hz~55Hz 频率范围: 10Hz~55Hz Amplitude: 0.75mm 振幅: 0.75mm 2 Hours in each direction, total 6 Hours X、Y、Z 三个相互垂直方向各振动2小时	MIL-STD-883E Method 2007.3
10	Leakage Test (气密性)	Take measurements with a helium Leakage detector 氦质检漏 Leakage Rate≤1×10 <sup>-3</sup> Pa cm <sup>3</sup> /s 漏率≤1×10 <sup>-3</sup> Pa cm <sup>3</sup> /s	MIL-STD-883E