

■ Features

- Maximum output current  
 $I_{OM}: 0.1A$
- Output voltage  
 $V_O: 5V$
- Continuous total dissipation  
 $P_D: 0.6 W (T_a = 25^\circ C)$

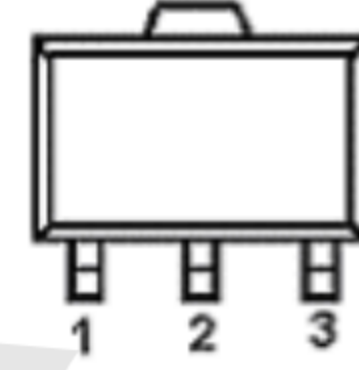

1.OUT  
2.GND  
3.IN

■ Absolute Maximum Ratings  $T_a = 25^\circ C$

Parameter	Symbol	Value	Unit
Input Voltage	$V_i$	30	V
Thermal Resistance from Junction to Ambient	$R_{\theta JA}$	160	$^\circ C/W$
Operating Junction Temperature Range	$T_{OPR}$	-40~+125	$^\circ C$
Storage Temperature Range	$T_{STG}$	-65~+150	$^\circ C$

■ Electrical Characteristics ( $V_i=10V, I_o=40mA, 0^\circ C < T_j < 125^\circ C, C_1=0.33 \mu F, C_o=0.1 \mu F$ , unless otherwise specified)

Parameter	Symbol	Test conditions	Min	Typ	Max	Unit	
Output voltage	$V_o$	$7V \leq V_i \leq 20V, I_o = 1mA \sim 40mA$	25 $^\circ C$	4.80	5.0	5.20	V
				4.85	5.0	5.15	V
				4.90	5.0	5.10	V
		$I_o = 1mA \sim 70mA$	0-125 $^\circ C$	4.75	5.0	5.25	V
4.75	5.0			5.25	V		
Load Regulation	$\Delta V_o$	$I_o = 1mA \sim 100mA$	25 $^\circ C$	15	60	mV	
		$I_o = 1mA \sim 40mA$	25 $^\circ C$	8	30	mV	
Line regulation	$\Delta V_o$	$7V \leq V_i \leq 20V$	0-125 $^\circ C$	32	150	mV	
		$8V \leq V_i \leq 20V$	25 $^\circ C$	26	100	mV	
Quiescent Current	$I_q$		25 $^\circ C$	3.8	6	mA	
Quiescent Current Change	$\Delta I_q$	$8V \leq V_i \leq 20V$	0-125 $^\circ C$		1.5	mA	
		$1mA \leq I_o \leq 40mA$	0-125 $^\circ C$		0.1		
Output Noise Voltage	$V_N$	10Hz $\leq f \leq$ 100KHz	25 $^\circ C$	42		$\mu V/V_o$	
Ripple Rejection	RR	$8V \leq V_i \leq 20V, f=120Hz$	0-125	41	49	dB	
Dropout Voltage	$V_d$		25 $^\circ C$	1.7		V	

■ Typical application.

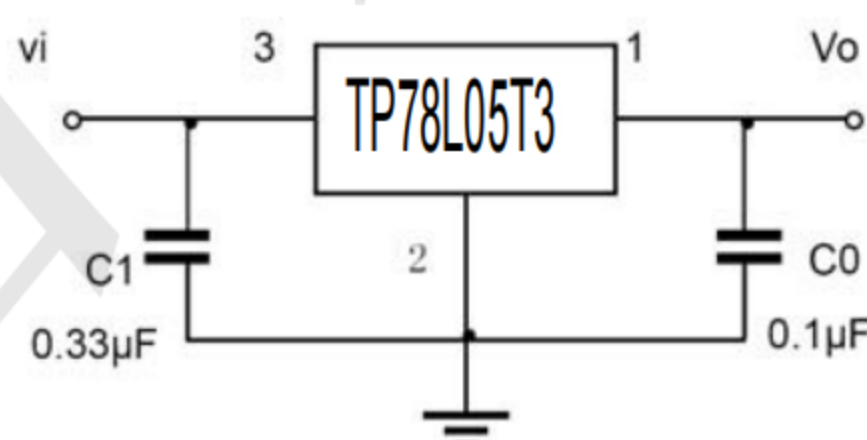

**Typical Electrical Characteristic Curves**

**Output Characteristics**

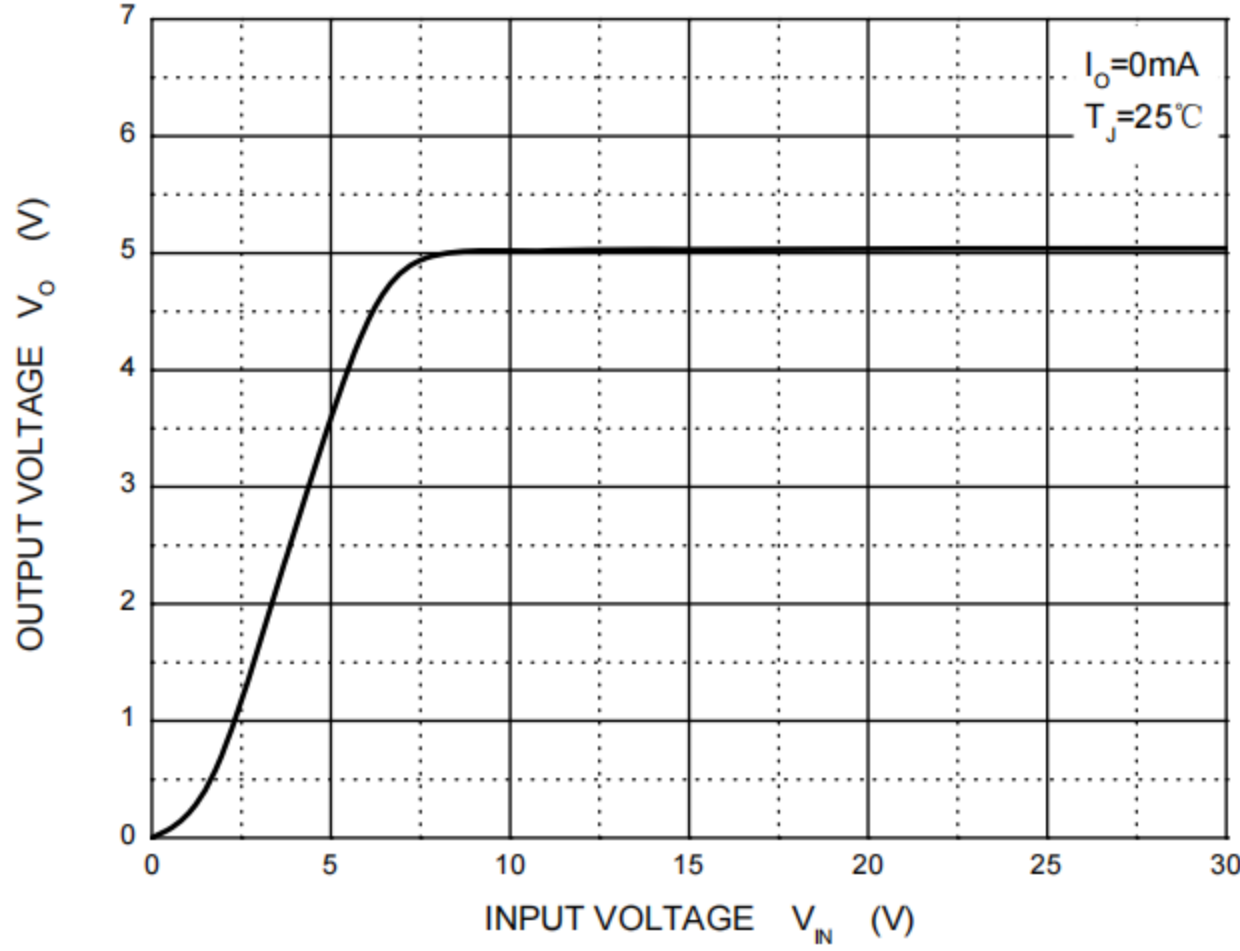

**Dropout Characteristics**

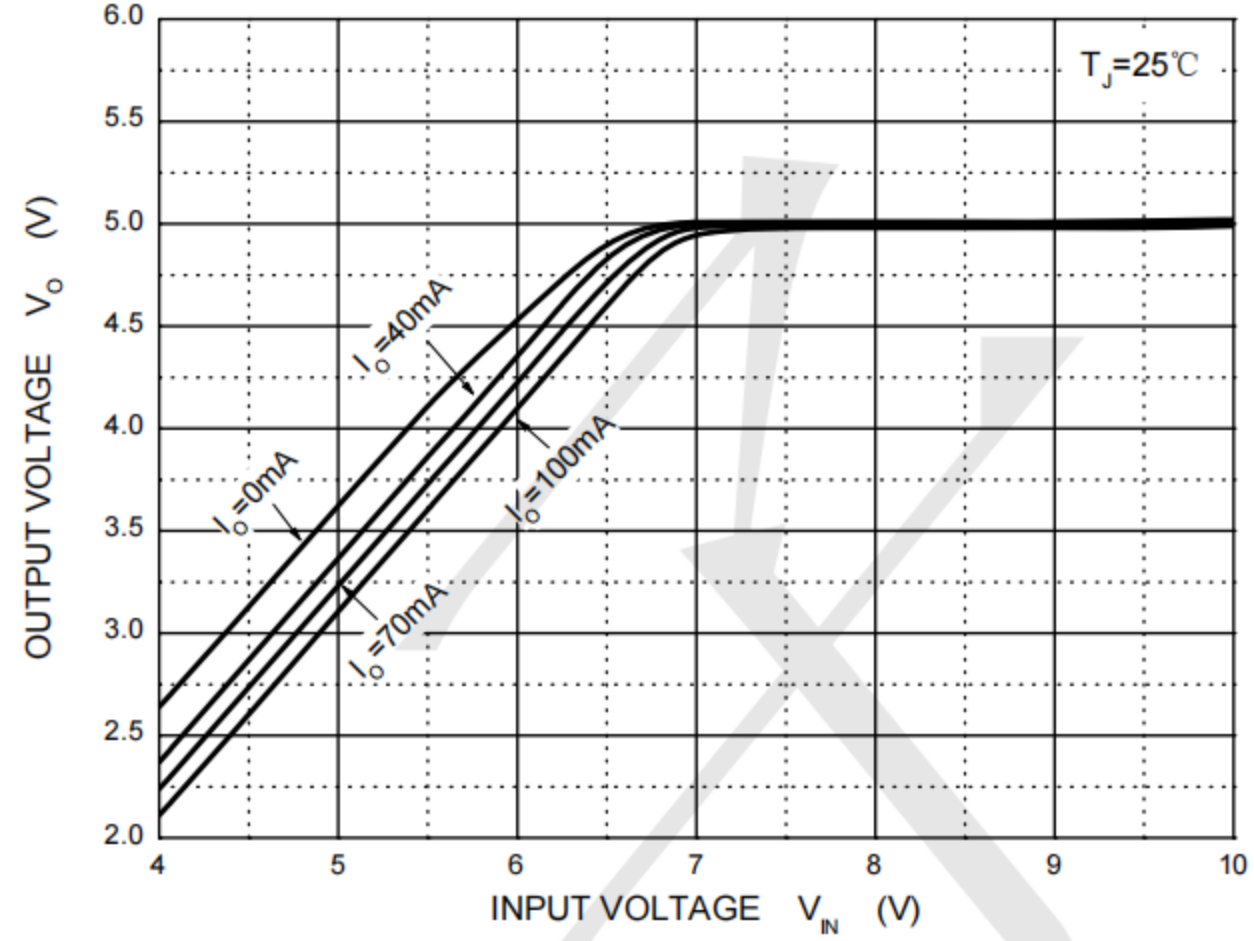

**Quiescent Current vs Input Voltage**

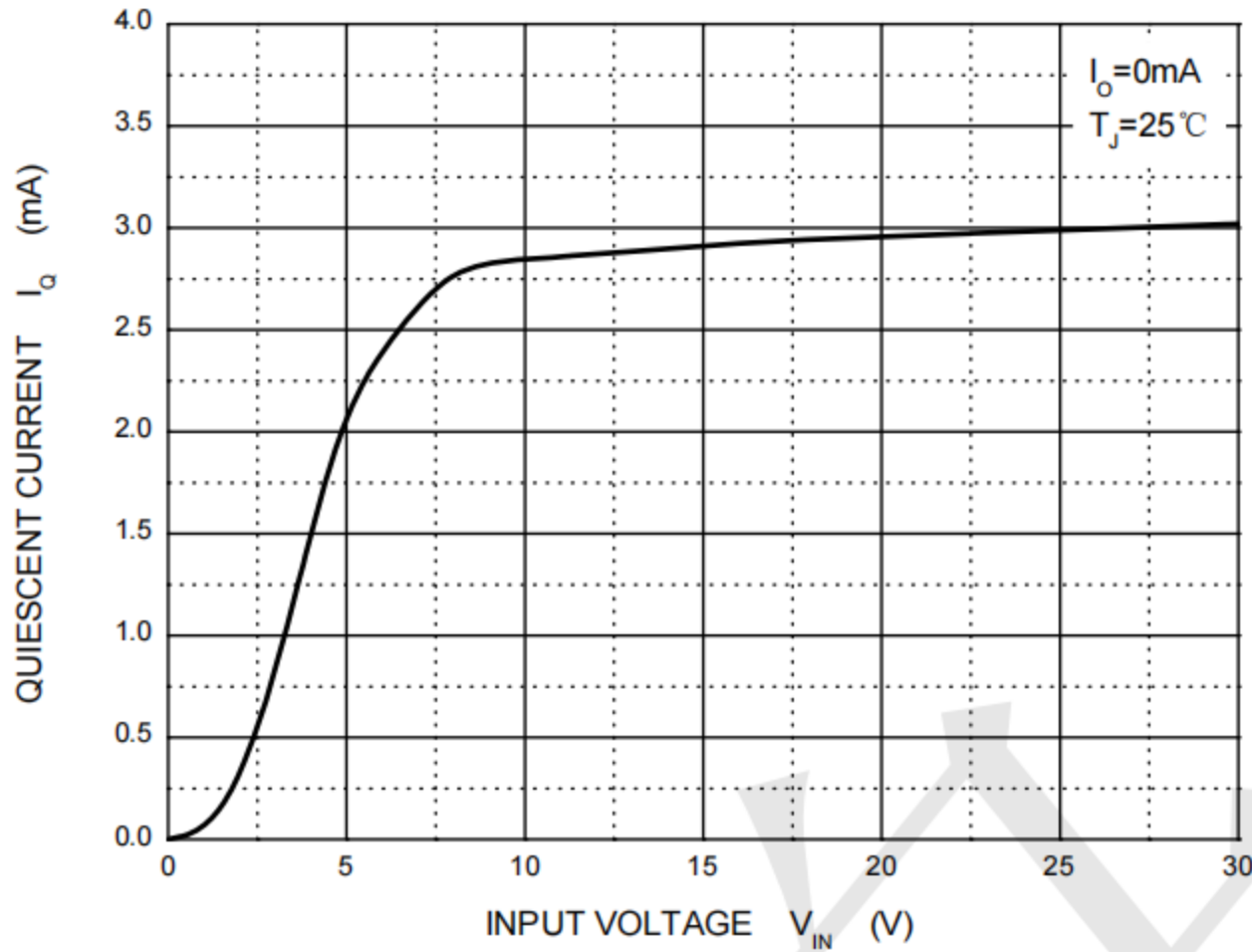

**Current Cut-off Grid Voltage**

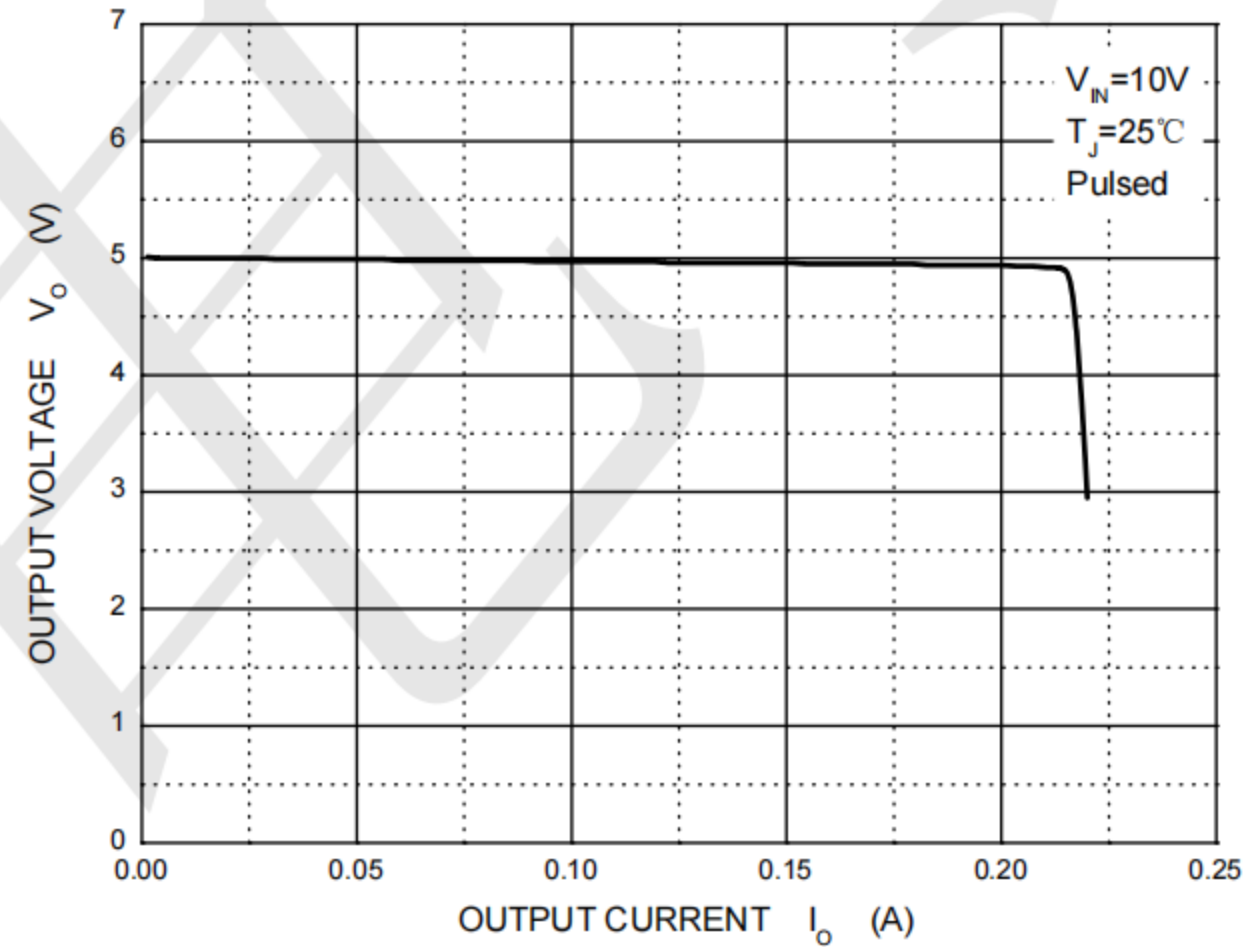

**Output Voltage vs Junction Temperature**

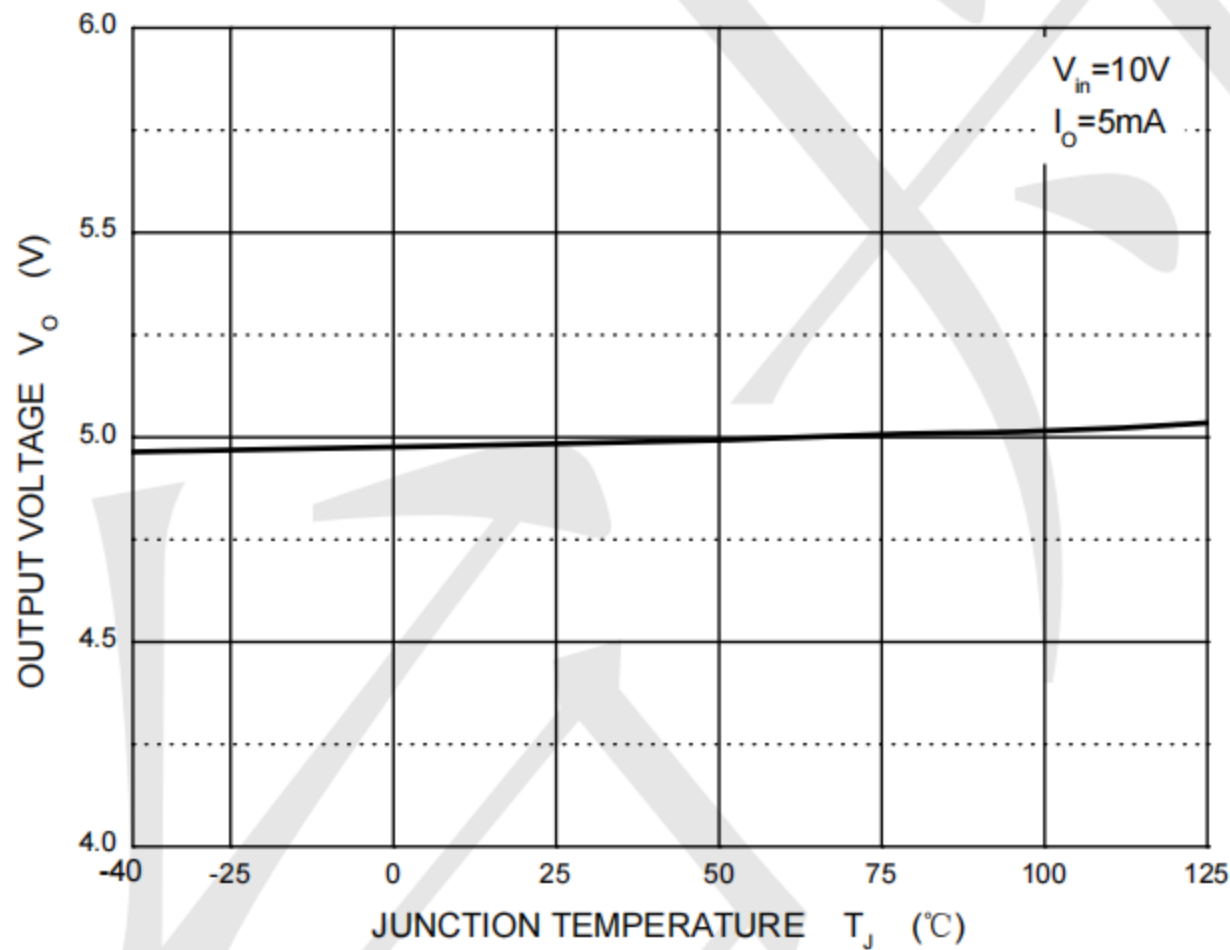

**Power Derating Curve**

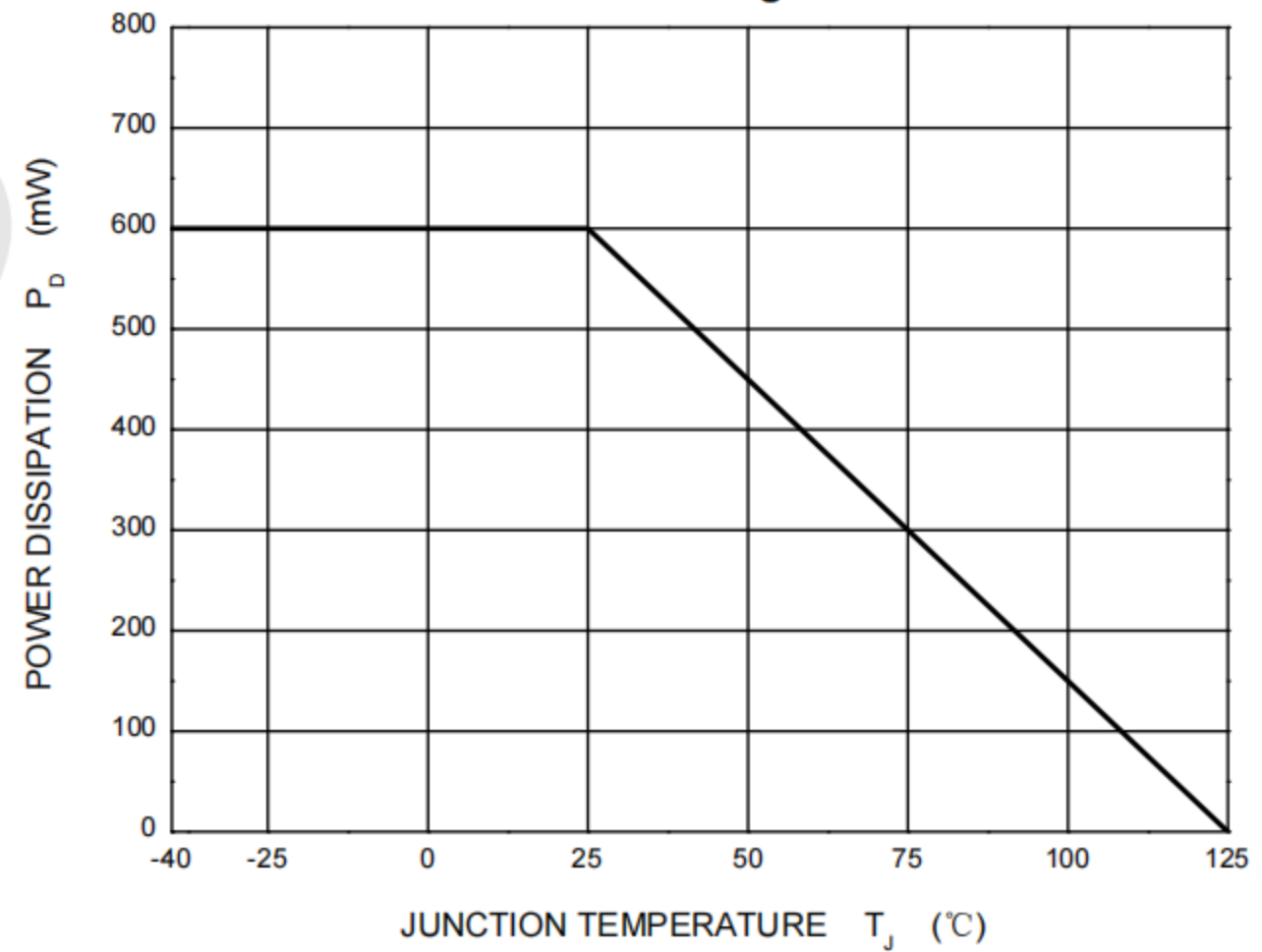



**Package information**

SOT89-3

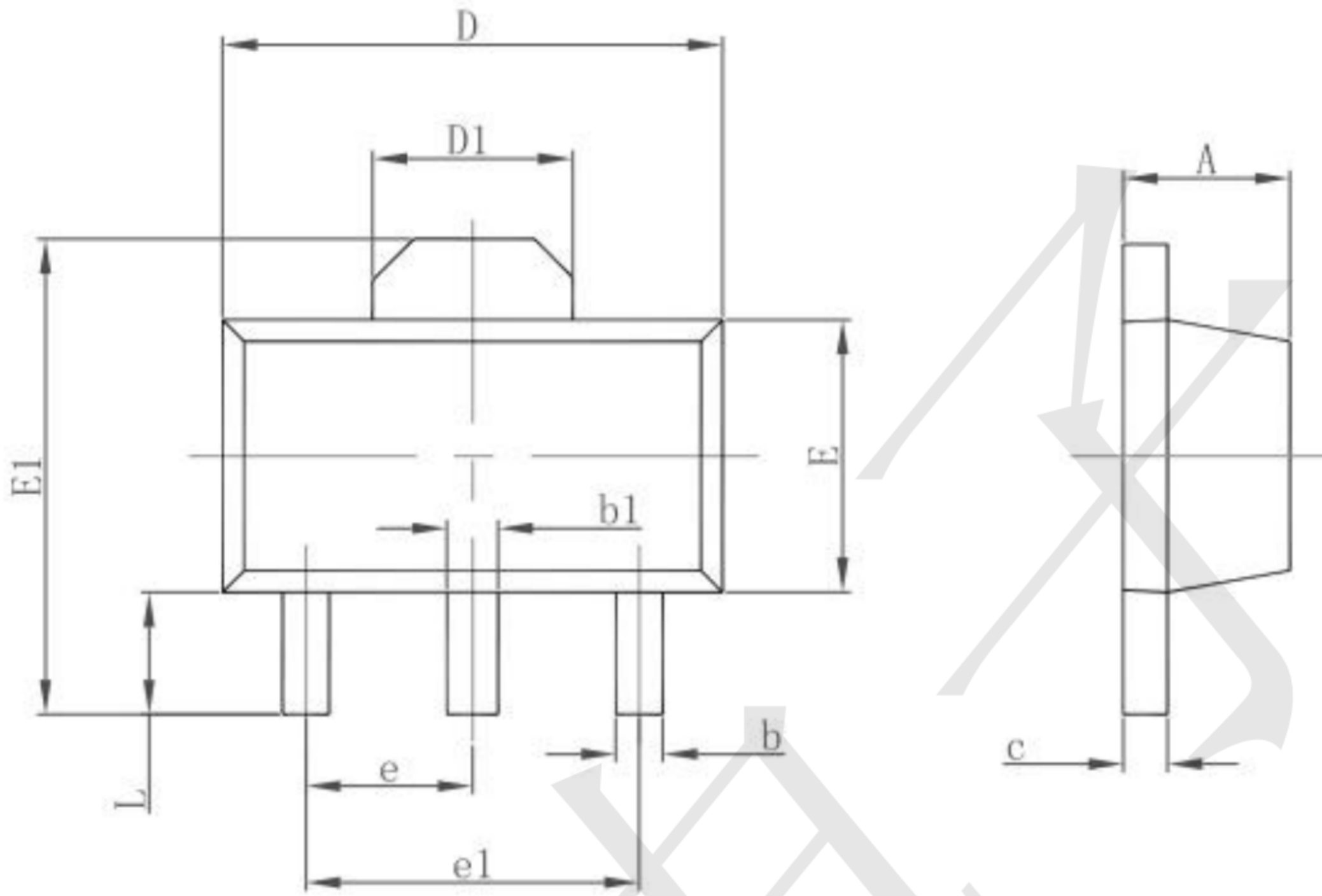

Symbol	Dimensions In Millimeters		Dimensions In Inches	
	Min.	Max.	Min.	Max.
A	1.400	1.600	0.055	0.063
b	0.320	0.520	0.013	0.020
b1	0.400	0.580	0.016	0.023
c	0.350	0.440	0.014	0.017
D	4.400	4.600	0.173	0.181
D1	1.550 REF.		0.061 REF.	
E	2.300	2.600	0.091	0.102
E1	3.940	4.250	0.155	0.167
e	1.500 TYP.		0.060 TYP.	
e1	3.000 TYP.		0.118 TYP.	
L	0.900	1.200	0.035	0.047