

内置BOOST升压和防破音功能的11W D/AB类音频功率放大器

■ 特点

- 防削顶失真功能(防破音, Anti-Clipping Function, ACF)
- 免滤波器数字调制, 直接驱动扬声器
- 输出功率
 - 9.0W ($V_{BAT}=3.7V$, $PVDD = 7.5V$, $R_L=3\Omega$, $THD+N=10\%$)
 - 11.0W ($V_{BAT}=3.7V$, $PVDD = 7.5V$, $R_L=2\Omega$, $THD+N=10\%$)
 - 5.5W ($V_{BAT}=3.7V$, $PVDD = 6.5V$, $R_L=4\Omega$, $THD+N=10\%$)
 - 3.15W ($V_{BAT}=3.7V$, $PVDD = 7.5V$, $R_L=8\Omega$, $THD+N=1\%$)
- 电源
 - 升压输入 V_{BAT} : 2.5V至5.5V
 - 升压输出 $PVDD$: V_{BAT} 至7.5V
- BOOST输出电压可调
- AB/D类可切换
- 保护功能:过流/过热/欠压异常保护功能
- 无铅封装, SOP8L-PP

■ 应用

- | | |
|---|--|
| <ul style="list-style-type: none"> · 蓝牙音箱 · 2.1声道小音箱 · iphone/ipod/ipod docking · 平板电脑, 笔记本电脑 | <ul style="list-style-type: none"> · 便携式音箱 · 扩音器 · MP4, 导航仪 · 智能手机 |
|---|--|

■ 典型应用图

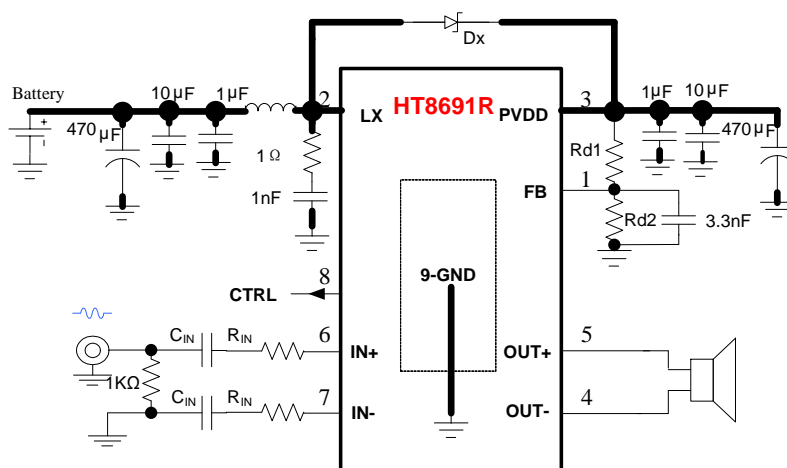

- 小尺寸LCD电视/监视器
- 便携式游戏机

■ 概述

HT8691R是一款内置BOOST升压模块的D类音频功率放大器。内置的BOOST升压模块可通过外置电阻调节升压值,即使是锂电池供电,在升压至7.5V, 2Ω负载条件下则能连续输出11W功率。其支持外部设置调节BOOST输出电压。

HT8691R的最大特点是防削顶失真 (ACF) 输出控制功能,可检测并抑制由于输入音乐、语音信号幅度过大所引起的输出信号削顶失真 (破音),也能自适应地防止在BOOST升压电压下降所造成的输出削顶,显著提高音质,创造非常舒适的听音享受,并保护扬声器免受过载损坏。同时芯片具有ACF-Off 模式。

HT8691R具有AB类和D类的自由切换功能,在受到D类功放EMI干扰困扰时,可随时切换至AB类音频功放模式。

HT8691R内部集成免滤波器数字调制技术,能够直接驱动扬声器,并最大程度减小脉冲输出信号的失真和噪音。输出无需滤波网络,极少的外部元器件节省了系统空间和成本,是便携式应用的理想选择。

此外, HT8691R内置的关断功能使待机电流最小化,还集成了输出端过流保护、片内过温保护和电源欠压异常保护等功能。

■ 引脚信息

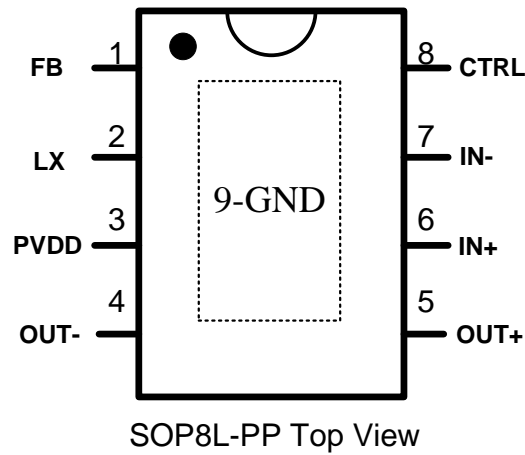

■ 引脚定义¹

SOP Terminal No.	Name	I/O	ESD Protection	Function
1	FB	I	PN	升压反馈点
2	LX	I	-	升压整流管输入
3	PVDD	Power	PN	升压输出和功率电源
4	OUT-	O	-	输出负端(BTL-)
5	OUT+	O	-	输出正端(BTL+)
6	IN+	I	PN	输入正端 (differential +)
7	IN-	I	PN	输入负端 (differential -)
8	CTRL	I	PN	模式控制输入端
9	GND ²	GND	PN	电源地

■ 订货信息

产品型号	封装形式	顶面标记	工作温度范围	包装和最小起订量
HT8691RSPET	SOP8L-PP	HT8691R _{SP}	-40°C~85°C	料管 / 100颗
HT8691RSPER	SOP8L-PP	HT8691R _{SP}	-40°C~85°C	编带 / 2500颗

¹ I: 输入端 O: 输出端

² 请确保 GND 脚连接至电源地。

11W Anti-Clipping Mono Class D/AB Audio Amplifier with Boost Converter

■ FEATURE

- Anti-Clipping Function (ACF)
- Filter-less Modulation, Eliminating Output Filter
- Output Power
 - 9.0W ($V_{BAT}=3.7V$, $PVDD = 7.5V$, $R_L=3\Omega$, $THD+N=10\%$)
 - 11.0W ($V_{BAT}=3.7V$, $PVDD = 7.5V$, $R_L=2\Omega$, $THD+N=10\%$)
 - 5.5W ($V_{BAT}=3.7V$, $PVDD = 6.5V$, $R_L=4\Omega$, $THD+N=10\%$)
 - 3.15W ($V_{BAT}=3.7V$, $PVDD = 7.5V$, $R_L=8\Omega$, $THD+N=1\%$)
- Power Supply
 - Boost Input V_{BAT} : 2.5V to 5.5V
 - Boost Output $PVDD$: V_{BAT} to 7.5V
- Adjustable BOOST Output Voltage
- Class AB / Class D
- Over Current Protection, Thermal Protection, Low voltage malfunction prevention function included
- Pb-Free Packages , SOP8L-PP

■ APPLICATIONS

- | | |
|----------------------------|---------------------|
| • Bluetooth Speakers | • Portable Speakers |
| • 2.1 Channel Speakers | • Megaphone |
| • iphone/ipod/ipod docking | • MP4/GPS |
| • Tablet PC/Note Book | • Smart Phones |

■ TYPICAL APPLICATION

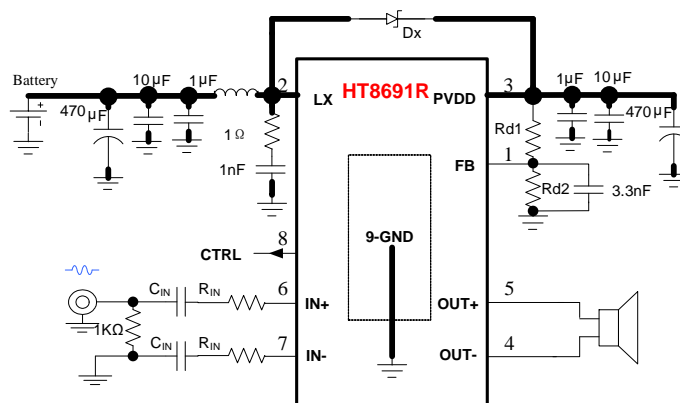

- LCD TV/Monitor
- Portable Gamers

■ GENERAL DESCRIPTION

HT8691R integrates a boost converter with a filter-less stereo class D audio power amplifier to provide 11W continuous power into a 2Ω speaker when operating from a Li-battery voltage boosted to 7.5V. Meanwhile, the boost output voltage is adjustable.

HT8691R features Anti-Clipping Function (ACF) which detects output signal clip due to the over input signal and suppresses the output signal clip automatically. Also, the ACF function can adapt the output clip caused by power supply voltage down with battery. It can significantly improve the sound quality, creating a very comfortable musical enjoyment, and to protect the speakers from overload damage. It also supplies ACF OFF mode.

Class AB amplifier mode is also available for HT8691R. Once the EMI Interference from class D and Boost Converter becomes an annoying problem, HT8691R can be changed into Class AB mode.

HT8691R has a filter-less modulation circuit which directly drives speakers while realizes low distortion and low noise characteristics. Thanks to filter-less, circuit design with fewer external parts can be made in portable applications.

HT8691R has the independent Shutdown function which can minimize the power consumption at standby and MUTE function. As for protection function, over current protection function for speaker output terminals, over temperature protection function, and low supply voltage malfunction preventing function are also prepared.

■ TERMINAL CONFIGURATION

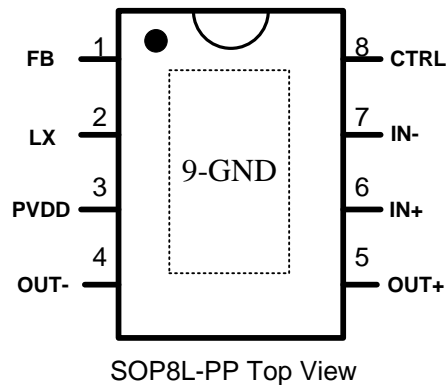

■ TERMINAL FUNCTION ¹

SOP Terminal No.	Name	I/O	ESD Protection	Function
1	FB	I	PN	Regulator Feedback Input
2	LX	I	-	Internal Switch Input
3	PVDD	Power	PN	Boost Converter Output Voltage and Power Supply
4	OUT-	O	-	Negative Output Terminal (BTL-)
5	OUT+	O	-	Positive Output (BTL+)
6	IN+	I	PN	Positive Input Terminal (differential +)
7	IN-	I	PN	Negative Input Terminal (differential -)
8	CTRL	I	PN	Mode Control Terminal
9	GND ²	GND	PN	Power Ground

■ ORDERING INFORMATION

Part Number	Package Type	Marking	Operating Temperature Range	MOQ/Shipping Package
HT8691RSPET	SOP8L-PP	HT8691RSP	-40°C~85°C	100PCS / Tube
HT8691RSPER	SOP8L-PP	HT8691RSP	-40°C~85°C	2500PCS / Tape and Reel

¹ I: Input O: Output

² Do make sure that the GND pin is grounded into the Ground plane connecting into the power ground.

● ELECTRICAL CHARACTERISTIC

● Absolute Maximum Ratings¹

Item	Symbol	Min.	Max.	Unit
BOOST converter output voltage and Power supply voltage range	PVDD	-0.3	7.8	V
Input terminal voltage range (IN+, IN-)	V _{IN}	-0.6	PVDD+0.6	V
Input terminal voltage range (except IN+, IN-)	V _{IN}	-0.3	PVDD+0.3	V
Operating Ambient Temperature	T _A	-40	85	°C
Junction Temperature	T _J	-40	150	°C
Storage Temperature	T _{STG}	-50	150	°C

● Recommended Operating Condition

Item	Symbol	Conditions	Min.	Typ.	Max.	Unit
BOOST converter output voltage and Power supply voltage range ²	PVDD		V _{BAT}	6.5	7.5	V
Operating Ambient Temperature	T _a		-40	25	85	°C
Speaker Impedance	R _L	SOP8L-PP		4		Ω

● Electrical Specification³

Item	Symbol	Conditions	Min.	Typ.	Max.	Unit
BOOST Converter						
Boost converter output voltage	PVDD		V _{BAT}	6.5	7.5	V
Boost converter frequency	f _{sw}			410		kHz
Boost converter input current limit	I _{LIMITRIP}			5		A

Item	Symbol	Conditions	Min.	Typ.	Max.	Unit
Class D Channel V _{SS} =0V, V _{BAT} =3.7V, R _{IN} = 0ohm, T _a =25°C, C _{IN} =2.2uF, ACF-Off mode, unless otherwise specified						
Carrier clock frequency	f _{PWM}			410		kHz
Over current protection	I _{max}				6	A
System Gain	A _{V0}	External R _{IN} =0Ω		28		dB
Start-up time (power-on or shutdown release)	t _{STUP}			130		ms
ACF attenuation gain	A _a		-16		0	dB
Consumption current in shutdown mode	I _{SD}	CTRL=V _{SS}		7		μA
Total Harmonic Distortion plus Noise	THD+N	P _O =1.0W, R _L =4Ω, f=1kHz		0.10		%
Output Noise	V _N	f=20Hz~20kHz, A weighted, A _v =28dB		135		μV _{rms}
Output offset voltage	V _{OS}			±2		mV
Quiescent current	I _{BAT}	No Load	Input Grounded, PVDD = 6.5V	20		mA
		With Load ⁴		20		mA

¹ Absolute Maximum Ratings is values which must not be exceeded to guarantee device reliability. With a system in which supply voltage might exceed supply voltage of PVDD/GND, external diodes are recommended to be used to assure that the voltage does not exceed the absolute maximum rating

² The rising time of PVDD should be more than 1μs.

³ Depending on parts and pattern layout, characteristics may be changed.

⁴ 4ohm resistor and 22uH coil are used as an output load in order to simulate a speaker.

Item	Symbol	Conditions	Min.	Typ.	Max.	Unit	
Class D Channel PVDD = 6.5V $V_{SS}=0V$, $V_{BAT}=3.7V$, $R_{IN}=0\Omega$, $T_a=25^\circ C$, $C_{IN}=2.2\mu F$, ACF-Off mode, unless otherwise specified							
Output Power	P_o	$R_L=4\Omega$	$V_{BAT}=3.7V$, $f=1kHz$, $THD+N=10\%$		5.5		W
		$R_L=3\Omega$			7		
		$R_L=2\Omega+33\mu H$			9		
		$R_L=8\Omega$			3.1		
		$R_L=4\Omega$	$V_{BAT}=3.7V$, $f=1kHz$, $THD+N=1\%$		4.4		
		$R_L=3\Omega$			5.5		
		$R_L=2\Omega+33\mu H$			5.5		
		$R_L=8\Omega$			2.5		
Efficiency (Class D + Boost)	η	$V_{BAT}=4.2V$, $R_L=4\Omega$, $THD+N=10\%$		75		%	
		$V_{BAT}=4.2V$, $R_L=3\Omega$, $THD+N=10\%$		70		%	
		$V_{BAT}=4.2V$, $R_L=2\Omega+33\mu H$, $THD+N=10\%$		66		%	
		$V_{BAT}=4.2V$, $R_L=8\Omega+33\mu H$, $THD+N=10\%$		80		%	

Item	Symbol	Conditions	Min.	Typ.	Max.	Unit	
Class D Channel PVDD = 7.0V $V_{SS}=0V$, $V_{BAT}=3.7V$, $R_{IN}=0\Omega$, $T_a=25^\circ C$, $C_{IN}=2.2\mu F$, ACF-Off mode, unless otherwise specified							
Output Power	P_o	$R_L=4\Omega$	$V_{BAT}=3.7V$, $f=1kHz$, $THD+N=10\%$		6.2		W
		$R_L=3\Omega$			7.6		
		$R_L=2\Omega+33\mu H$			9.5		
		$R_L=4\Omega$	$V_{BAT}=3.7V$, $f=1kHz$, $THD+N=1\%$		5.1		
		$R_L=3\Omega$			6.2		
		$R_L=2\Omega+33\mu H$			7.5		
Efficiency (Class D + Boost)	η	$V_{BAT}=4.2V$, $R_L=4\Omega$, $THD+N=10\%$		73		%	
		$V_{BAT}=4.2V$, $R_L=3\Omega$, $THD+N=10\%$		69		%	
		$V_{BAT}=4.2V$, $R_L=2\Omega+33\mu H$, $THD+N=10\%$		66		%	

Item	Symbol	Conditions	Min.	Typ.	Max.	Unit	
Class D Channel PVDD = 7.5V $V_{SS}=0V$, $V_{BAT}=3.7V$, $R_{IN}=0\Omega$, $T_a=25^\circ C$, $C_{IN}=2.2\mu F$, ACF-Off mode, unless otherwise specified							
Output Power	P_o	$R_L=8\Omega$	$V_{BAT}=3.7V$, $f=1kHz$, $THD+N=10\%$		3.9		W
		$R_L=4\Omega$			7		
		$R_L=3\Omega$			9		
		$R_L=2\Omega+33\mu H$			11		
		$R_L=8\Omega$	$V_{BAT}=3.7V$, $f=1kHz$, $THD+N=1\%$		3.15		
		$R_L=4\Omega$			5.5		
		$R_L=3\Omega$			7		
		$R_L=2\Omega+33\mu H$			8.8		
Efficiency (Class D + Boost)	η	$V_{BAT}=4.2V$, $R_L=8\Omega$, $THD+N=10\%$		82		%	
		$V_{BAT}=4.2V$, $R_L=4\Omega$, $THD+N=10\%$		72		%	
		$V_{BAT}=4.2V$, $R_L=3\Omega$, $THD+N=10\%$		68		%	
		$V_{BAT}=4.2V$, $R_L=2\Omega+33\mu H$, $THD+N=10\%$		66		%	

Class AB Channel ¹ V _{SS} =0V, V _{BAT} =3.6V, C _{IN} =2.2uF, R _{IN} =0ohm, T _a =25°C, C _{IN} =0.1uF, unless otherwise specified							
Output Power	P _O	RL=4Ω, V _{BAT} =3.6V	f=1kHz, THD+N=10%		1.3		W
		RL=4Ω, V _{BAT} =4.2V			1.8		
		RL=4Ω, V _{BAT} =5.0V			2.65		W
		RL=4Ω, V _{BAT} =3.6V	f=1kHz, THD+N=1%		1.0		W
		RL=4Ω, V _{BAT} =4.2V			1.5		W
		RL=4Ω, V _{BAT} =5.0V			2.1		W
Total Harmonic Distortion plus Noise	THD+N	P _O =0.01W	RL=4Ω, f=1kHz		0.1		%
		P _O =0.1W			0.09		%
Output Noise	V _N	f=20Hz~20kHz, A weighted			60		μV _{rms}
Signal to Noise Ratio	SNR	A weighted, THD+N = 1%			92		dB
Output offset voltage	V _{OS}				±4		mV
Efficiency	η	RL=4Ω+22uH, THD+N = 10%			70		%
		RL=8Ω+33uH, THD+N = 10%			74.5		%
Quiescent current	I _{BAT}	No Load	Input Grounded		20		mA
		With Load			20		mA
System Gain	A _{V0}	External R _{IN} =0Ω			22		dB
Start-up time (power-on, shutdown release, or switch from Class D to Class AB)	t _{STUP}				130		ms

Item	Symbol	Conditions	Min.	Typ.	Max.	Unit
CTRL Terminal Voltage						
ACF Off (Class D, Boost On) mode setting threshold voltage	V _{MOD1}		2.4		V _{BAT}	V
ACF-1 (Class D, Boost On) mode setting threshold voltage	V _{MOD2}		1.6		2.2	V
ACF Off (Class AB, Boost Off) mode setting threshold voltage ²	V _{MOD3}		0.4		1.4	V
SD mode setting threshold voltage	V _{MOD4}		V _{SS}		0.2	V
SD wake up voltage	V _{CTRL_ON}		0.8	1.0		V
Internal pull-down Resistor of CTRL	R _{CTRL}			300		K Ω
MISCELLANEOUS						
V _{BAT} start-up threshold voltage	V _{UVLH}			2.5		V
V _{BAT} shut-down threshold voltage	V _{UVLL}				2.0	V

¹ In Class AB amplifier mode, boost converter is shutdown automatically. Due to the schottky rectifier, the voltage of PVDD terminal can be lower than V_{BAT}, depending on the forward voltage of the rectifier V_F.

² ACF ON mode is only available in Class D amplifier mode.

TYPICAL OPERATING CHARACTERISTICS

Class D Channel

Condition: Class D mode, $V_{BAT} = 3.7V$, $f_{IN} = 1kHz$, $C_{IN} = 2.2\mu F$, external $R_{IN} = 0\Omega$, ACF off, unless otherwise specified

PVDD = 7.5V, Load = 4ohm

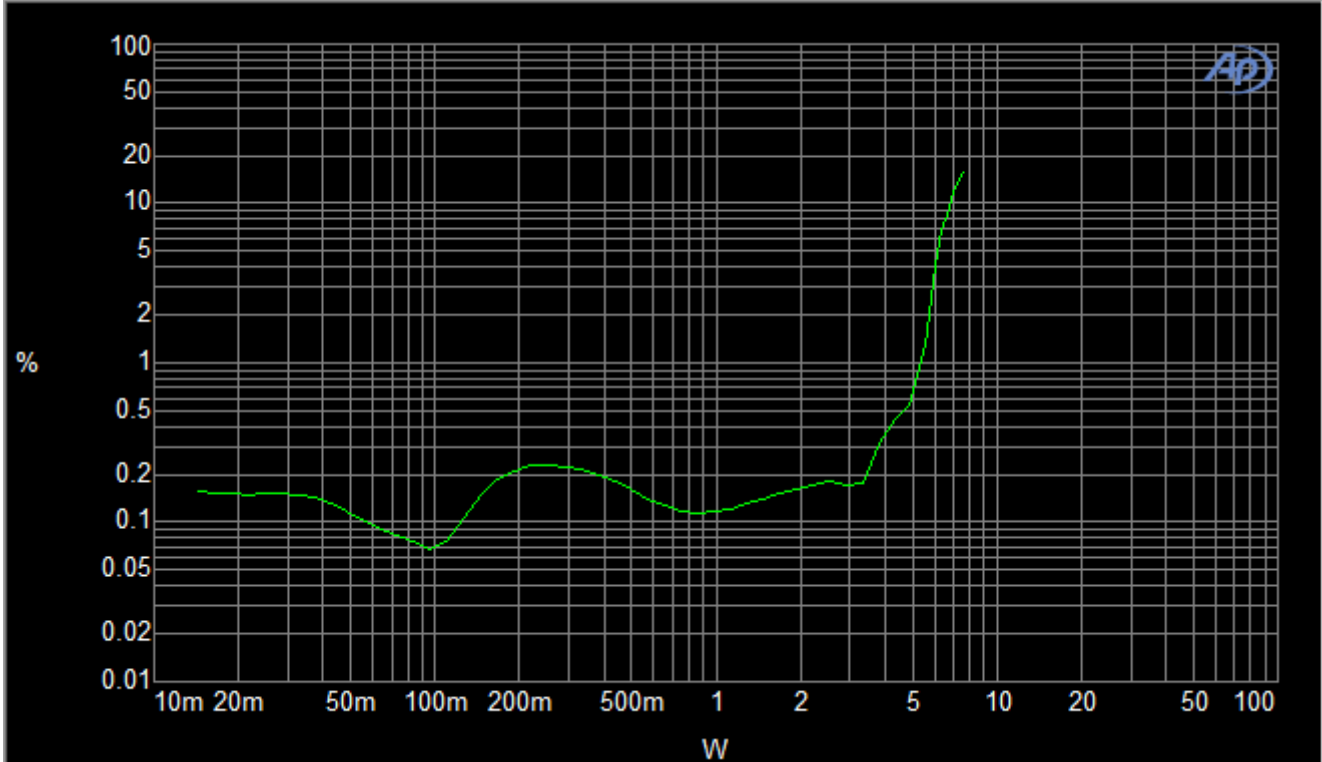

Output Power vs THD+N

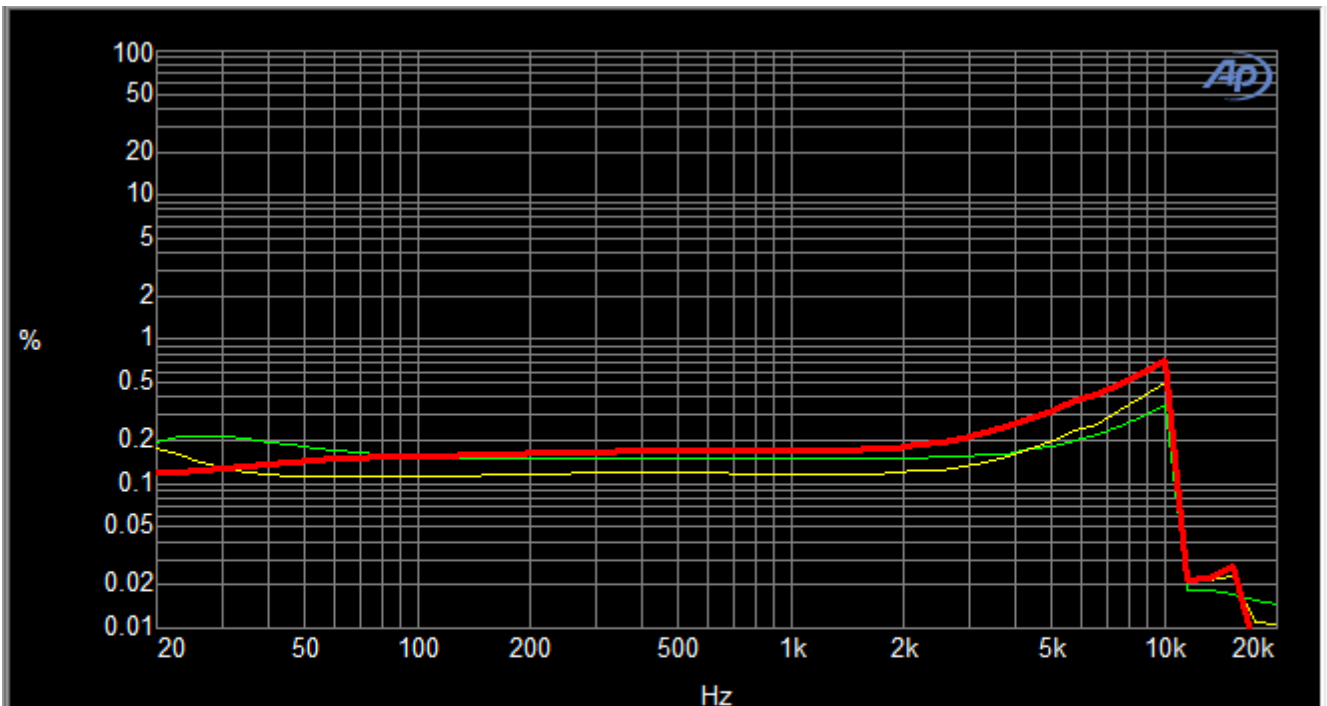

f_{IN} vs THD+N

	Sweep	Trace	Color	Line Style	Thick	Data	Axis	Comment
<input checked="" type="checkbox"/>	1	1	Green	Solid	1	Analyzer.TH _D +N	Left	Po = 0.5W
<input checked="" type="checkbox"/>	2	1	Yellow	Solid	1	Analyzer.TH _D +N	Left	Po = 1.0W
<input checked="" type="checkbox"/>	3	1	Red	Solid	1	Analyzer.TH _D +N	Left	Po = 2.0W

PVDD = 7.5V, Load = 8ohm

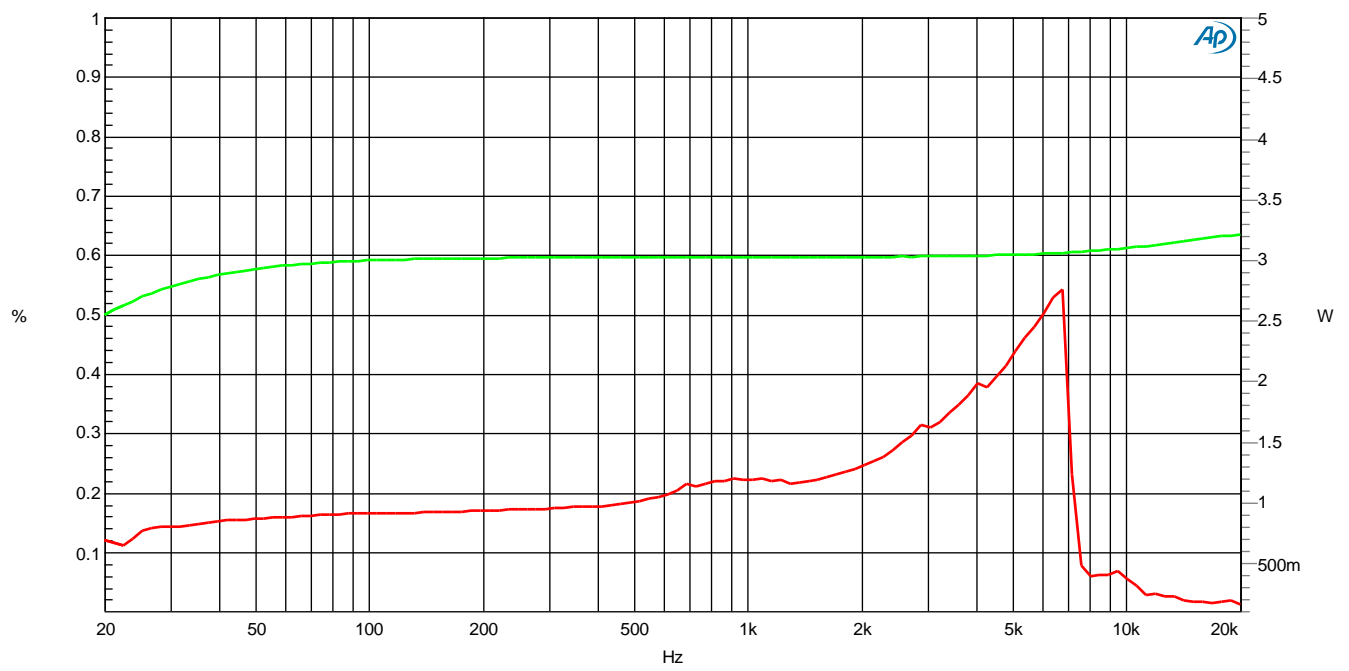
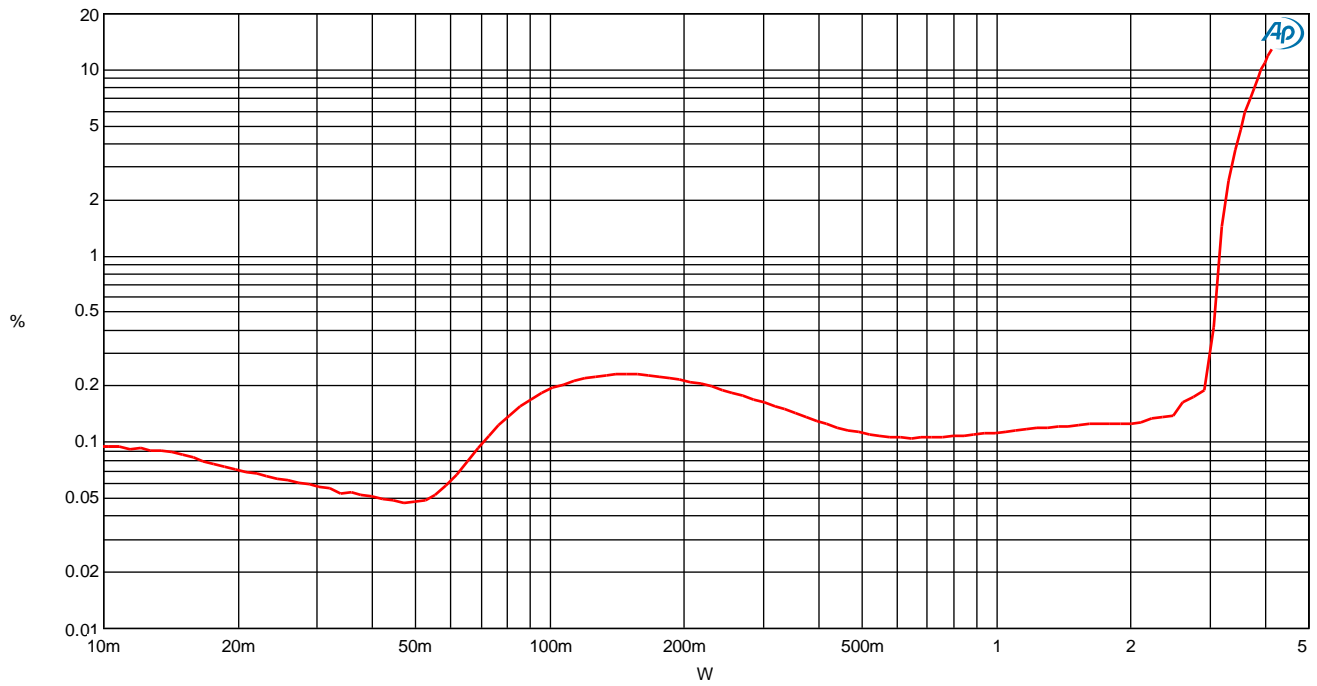

PVDD = 7.5V, Load = 3ohm

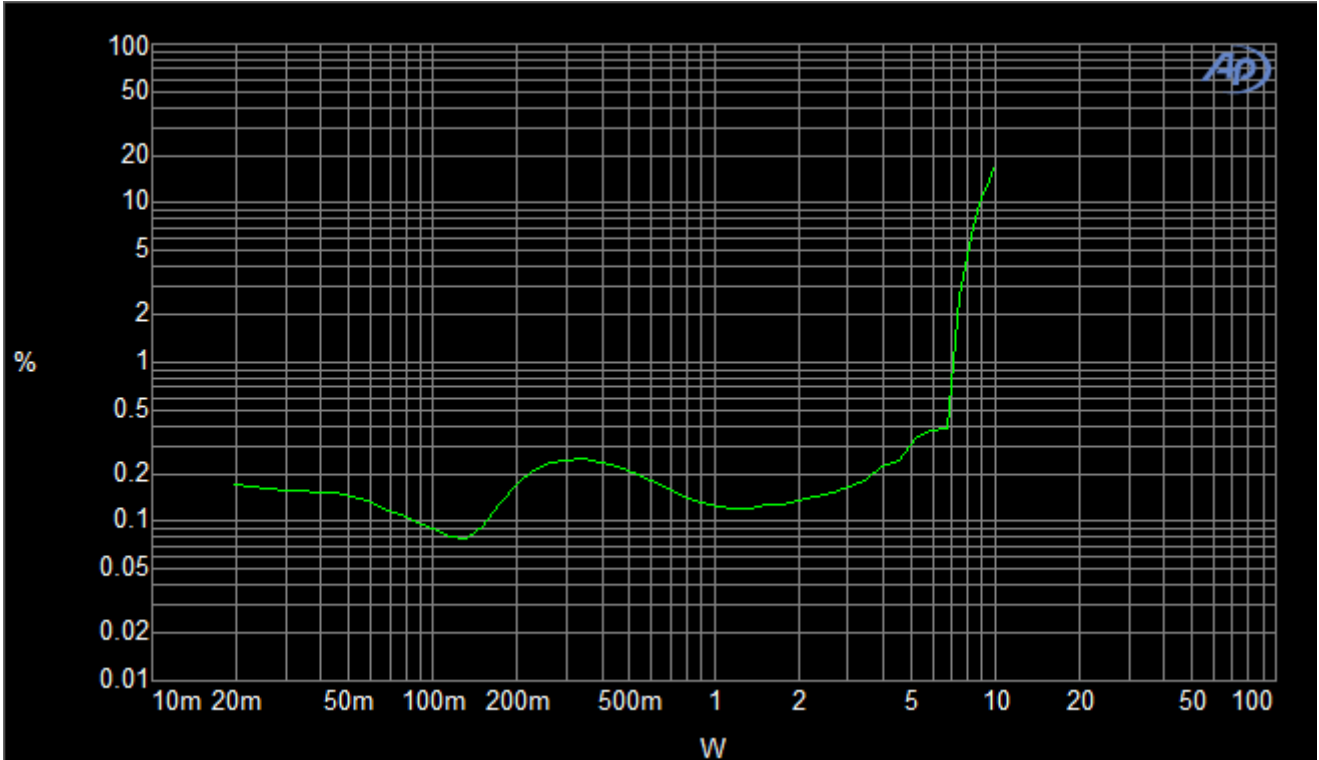

Output Power vs THD+N

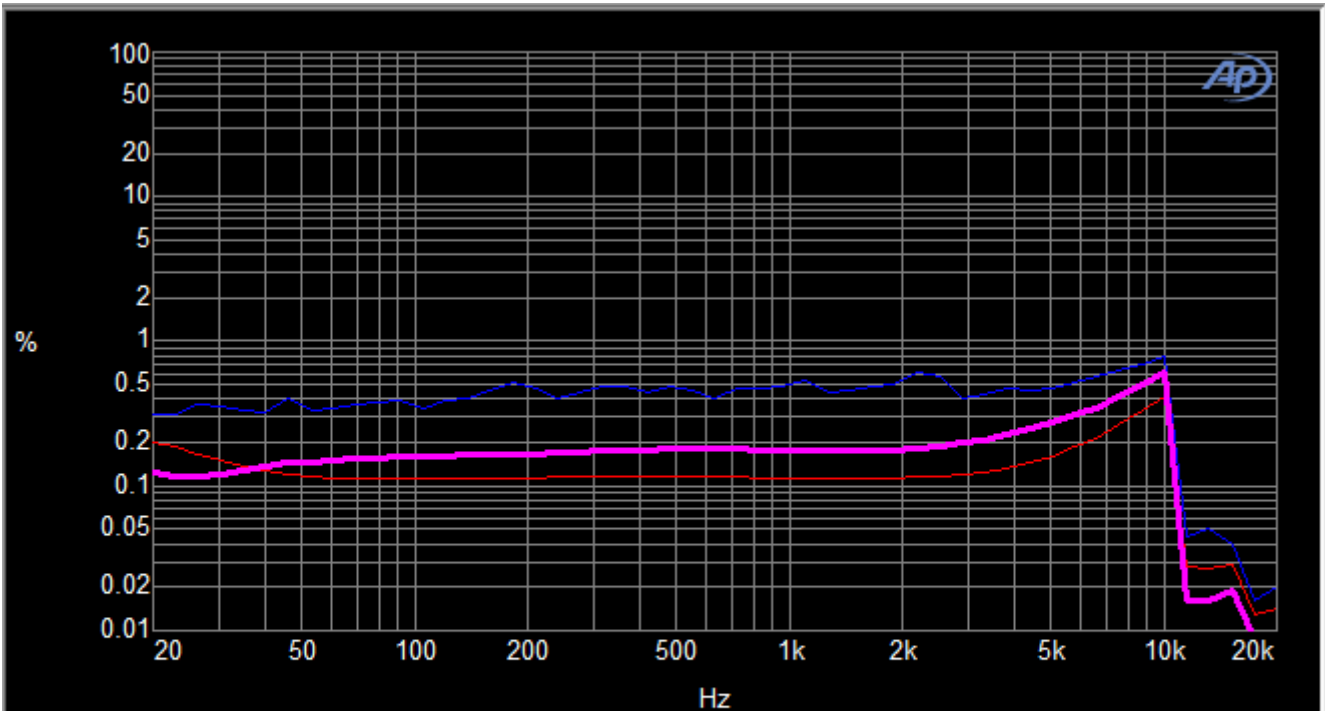

f_{IN} vs THD+N

	Sweep	Trace	Color	Line Style	Thick	Data	Axis	Comment
x	1	1	Red	Solid	1	Analyzer.TH	Left	Po = 1W
x	2	1	Mager	Solid	1	Analyzer.TH	Left	Po = 2W
x	3	1	Blue	Solid	1	Analyzer.TH	Left	Po = 3W

f_{IN} vs THD+N

PVDD = 7.5V, Load = 2ohm+33uH

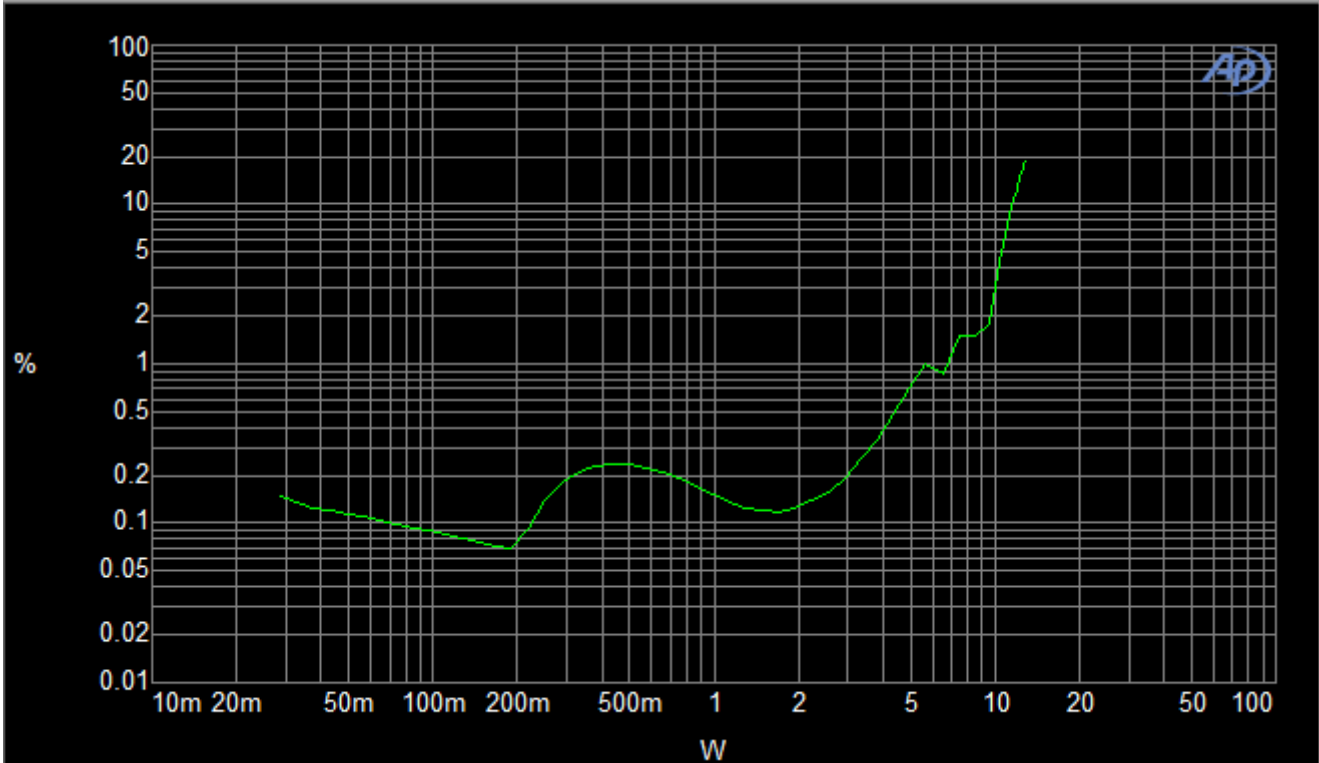

Output Power vs THD+N

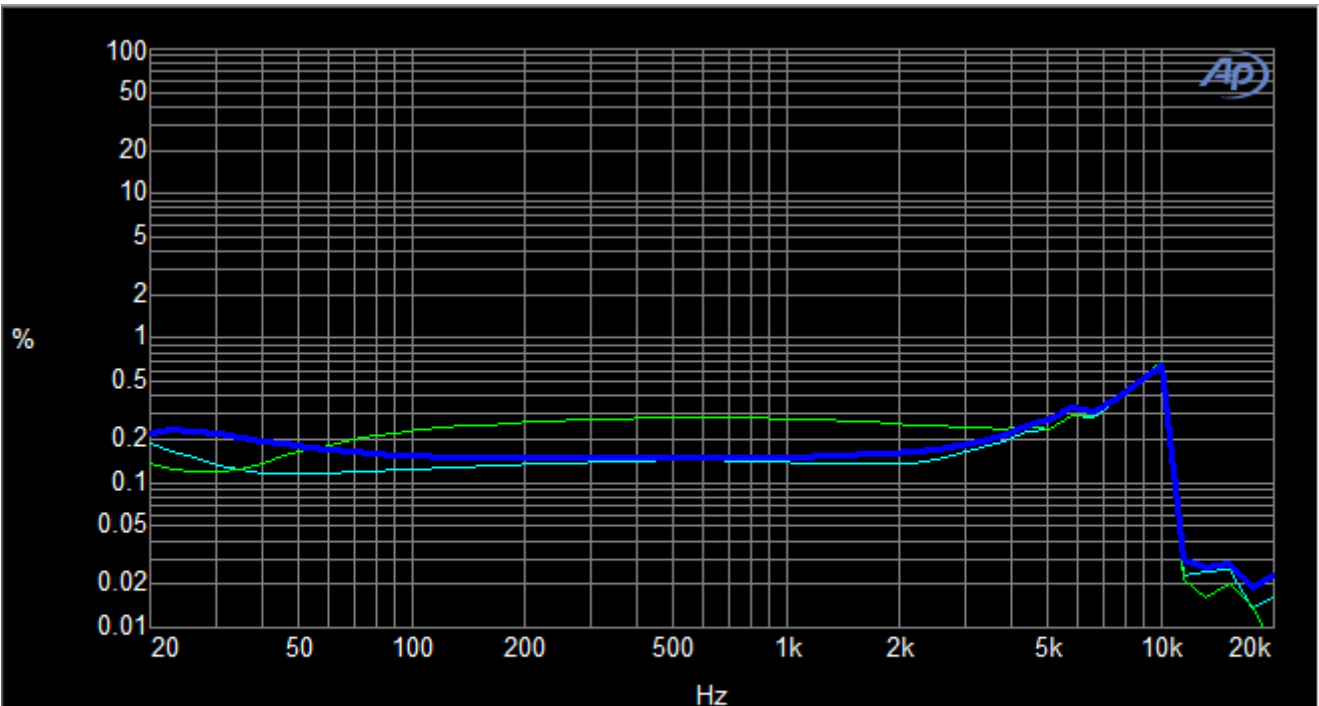

Sweep	Trace	Color	Line Style	Thick	Data	Axis	Comment
1	1	Blue	Solid	1	Analyzer.TH	Left	Po = 1W
2	1	Cyan	Solid	1	Analyzer.TH	Left	Po = 2W
3	1	Green	Solid	1	Analyzer.TH	Left	Po = 3W

f_{IN} vs THD+N

PVDD = 7.0V, Load = 4ohm

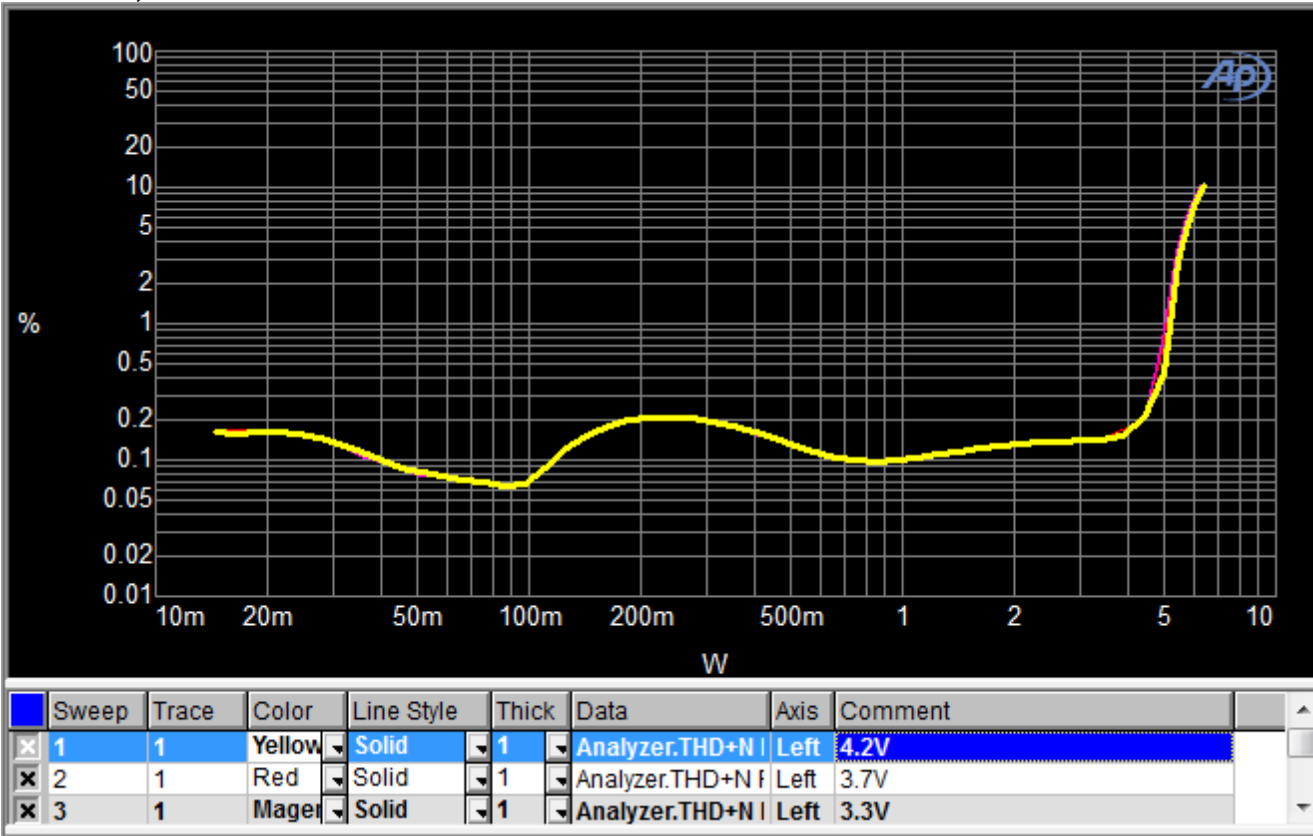

Output Power vs THD+N

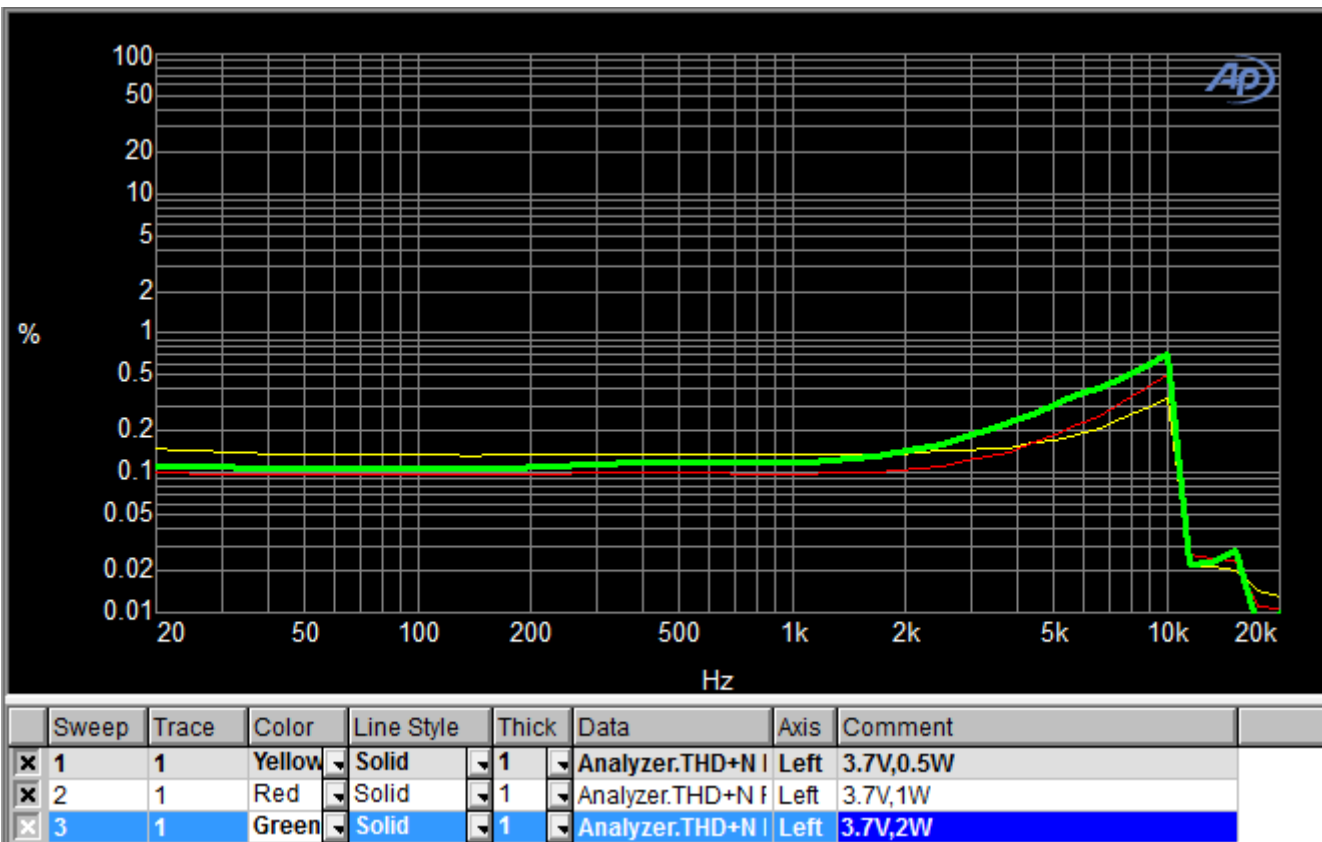

f_{IN} vs THD+N

PVDD = 7.0V, Load = 3ohm

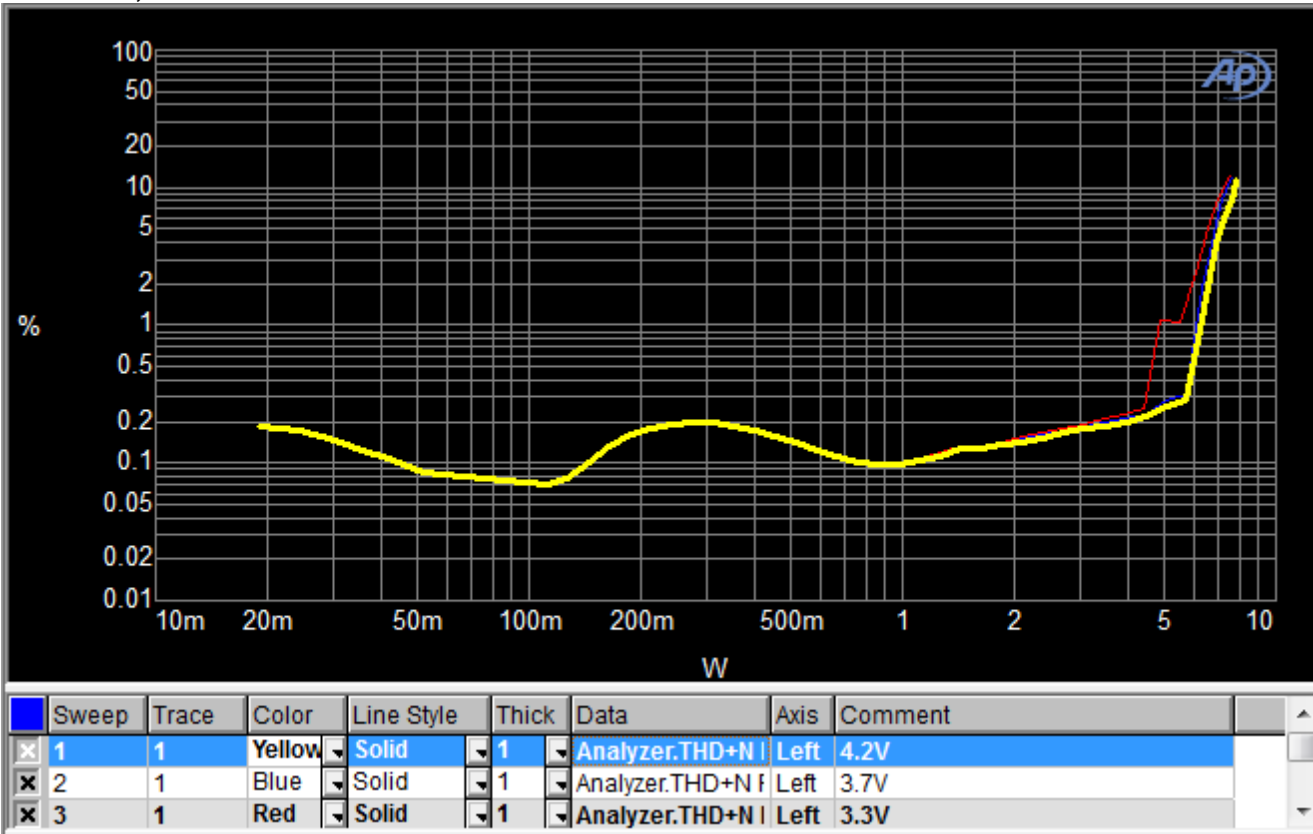

Output Power vs THD+N

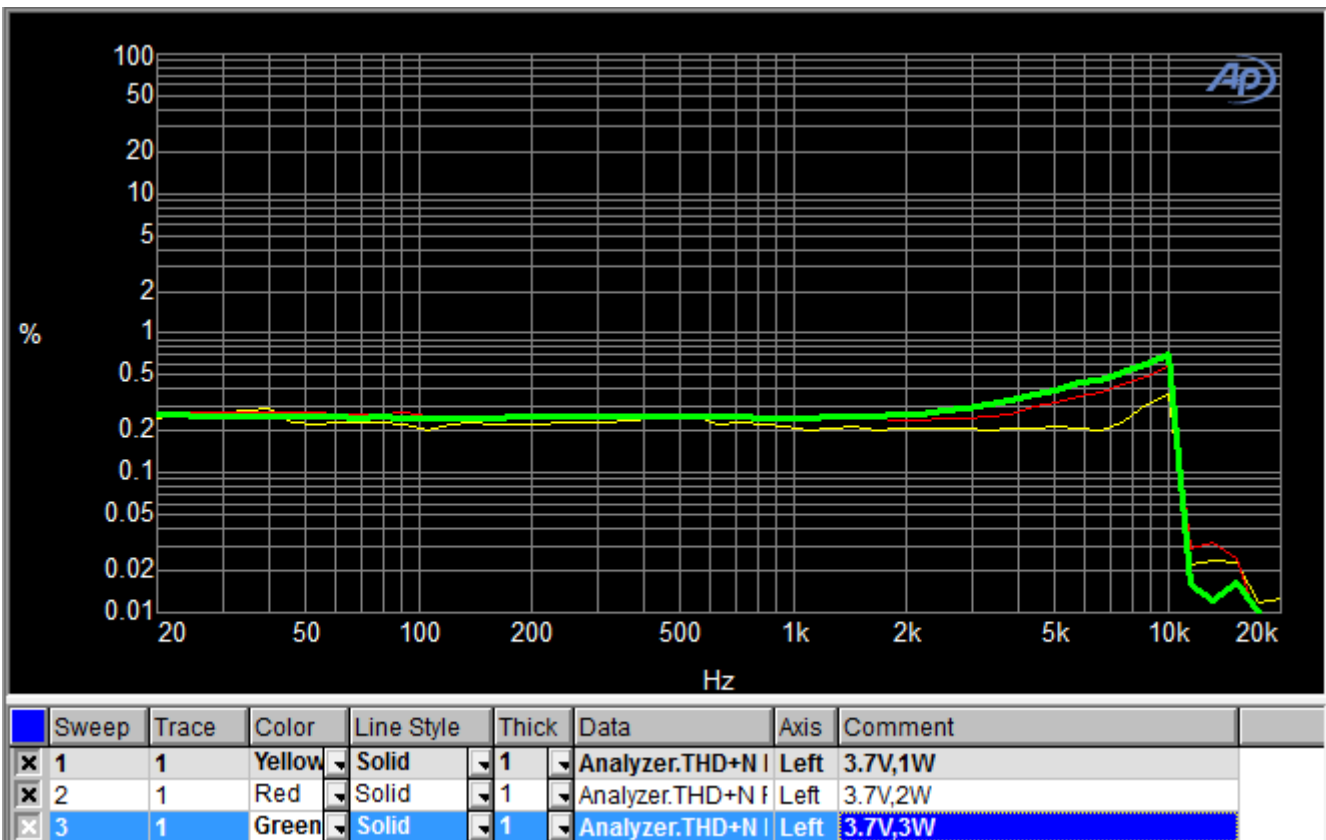

f_{IN} vs THD+N

PVDD = 7.0V, Load = 2ohm+33uH

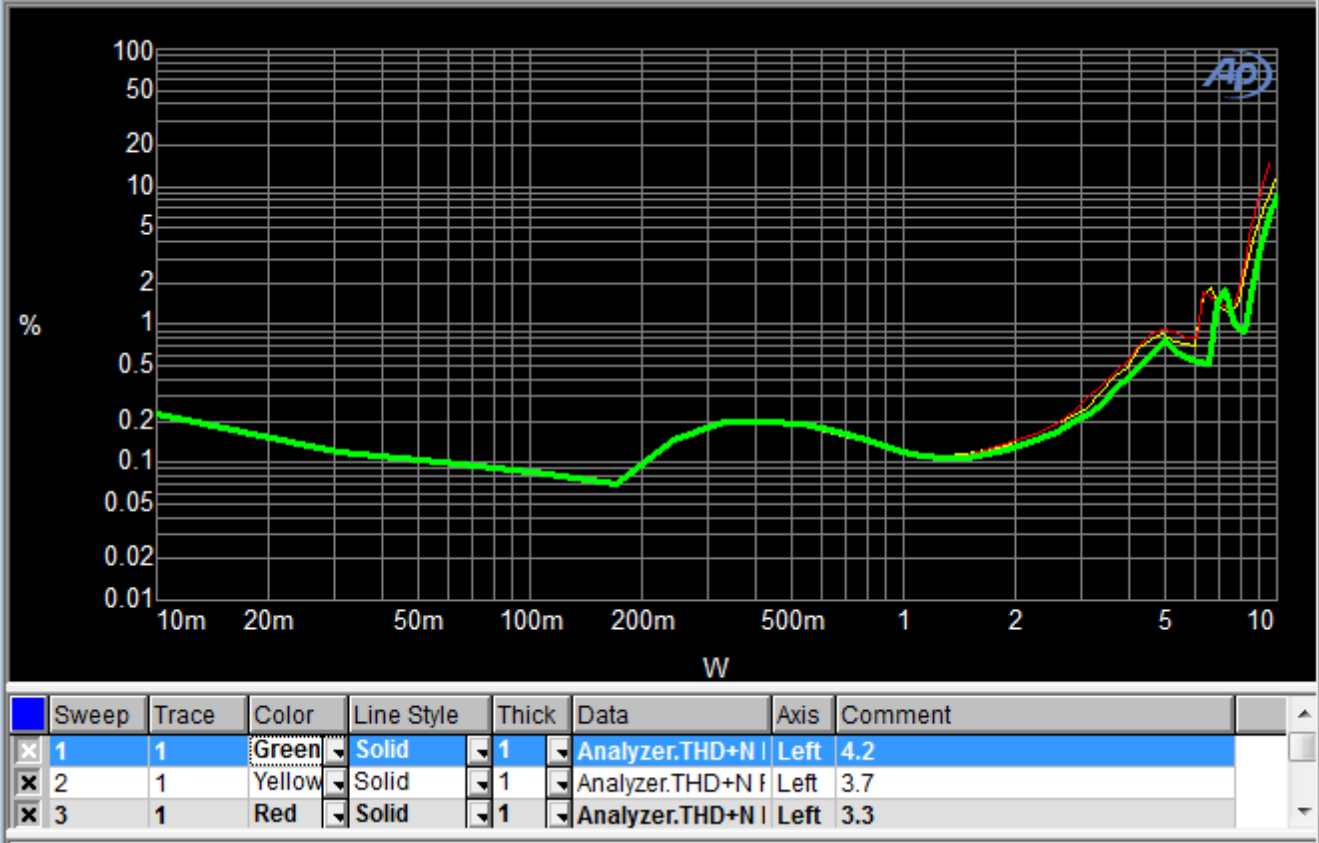

Output Power vs THD+N

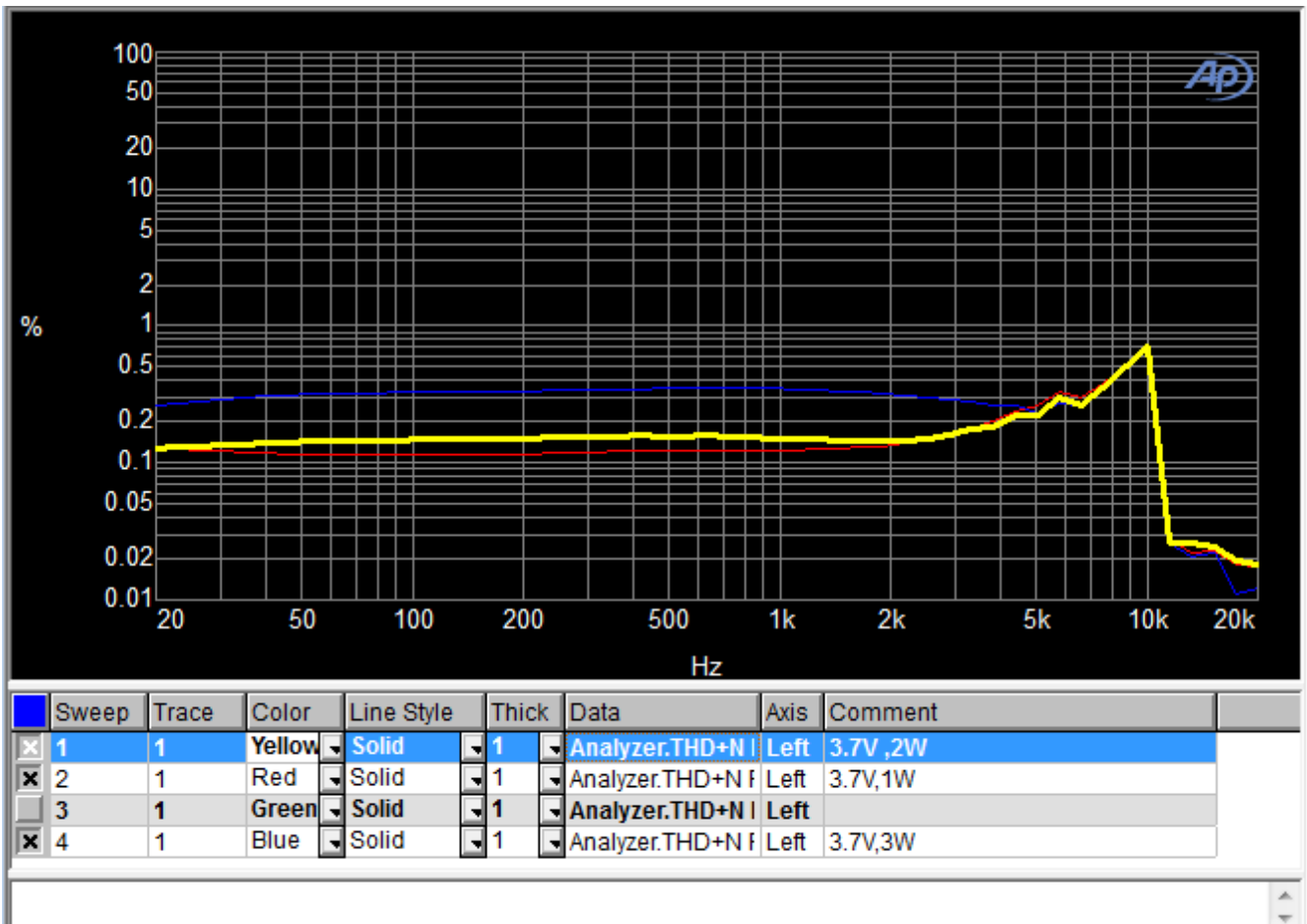

f_{IN} vs THD+N

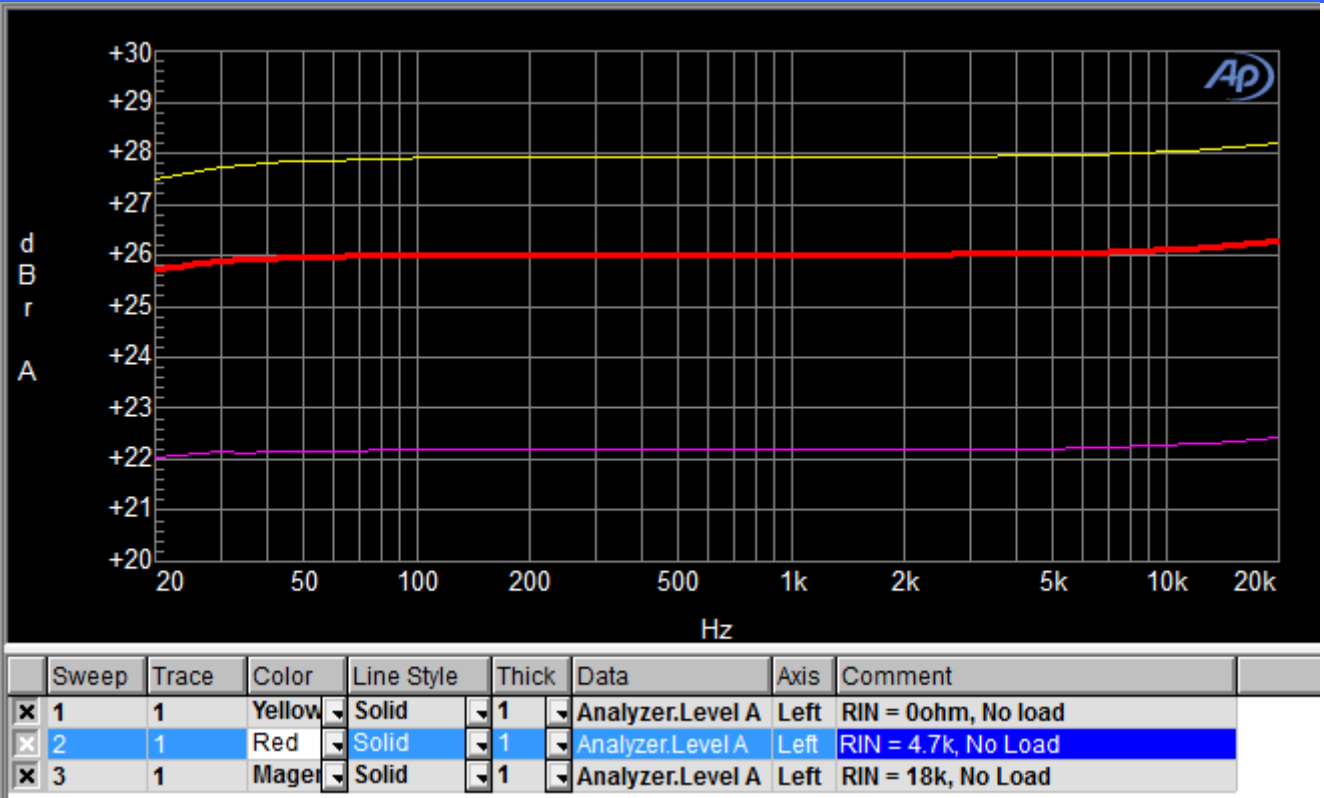

Frequency Respond

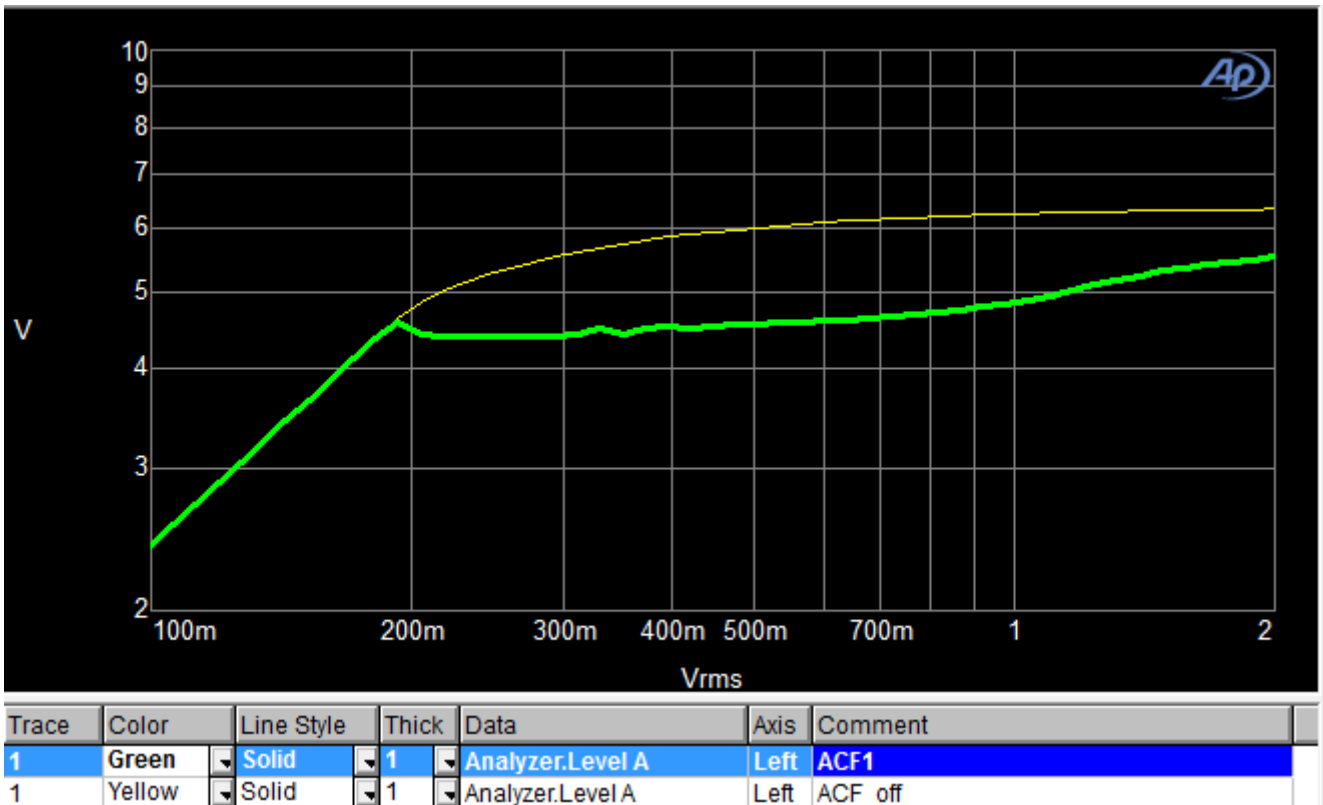

Input Voltage Level vs Output Voltage Level (PVDD = 7.5V, Load = 4ohm)

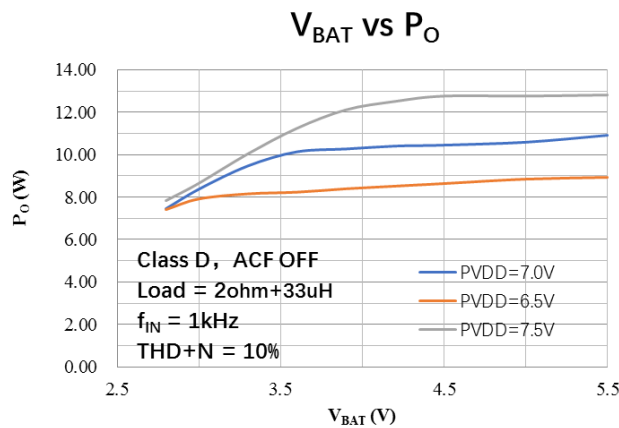
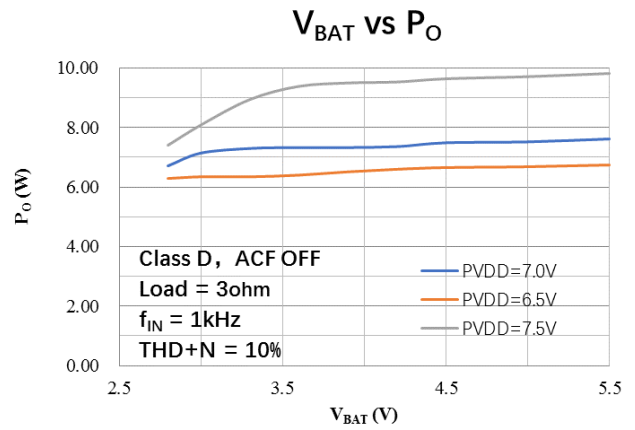
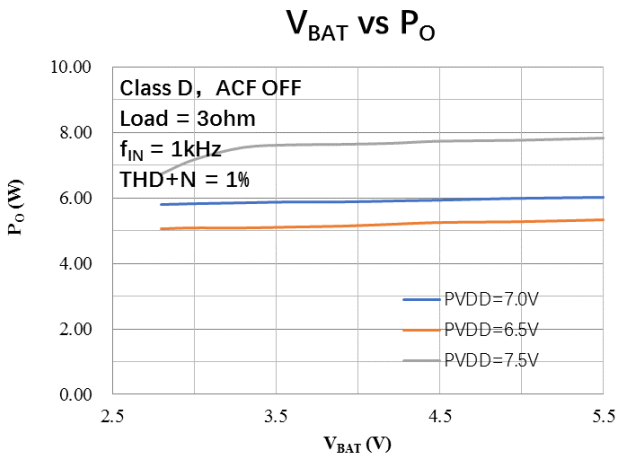
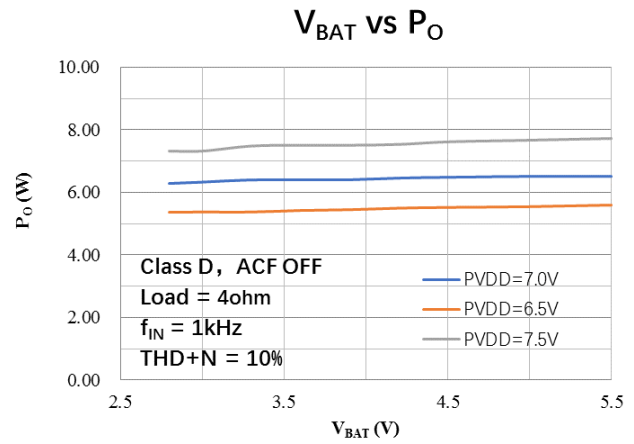
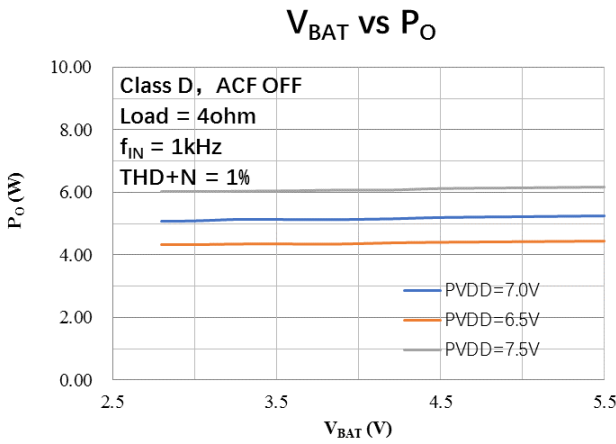
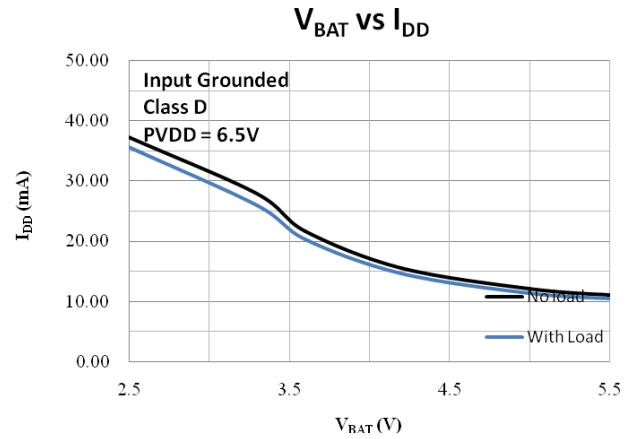
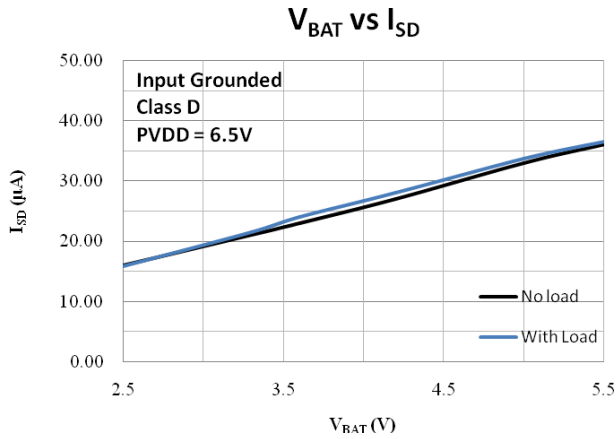

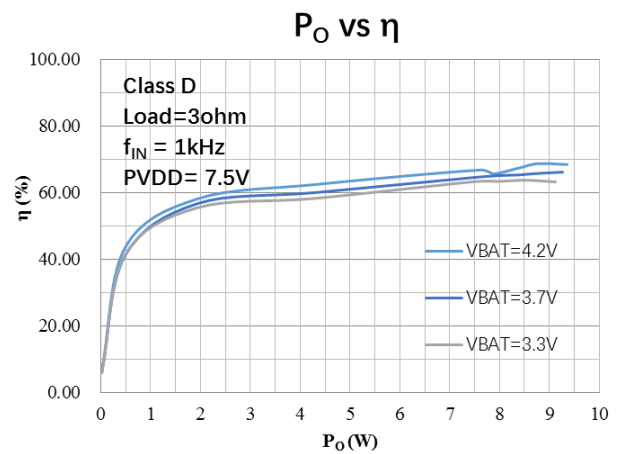
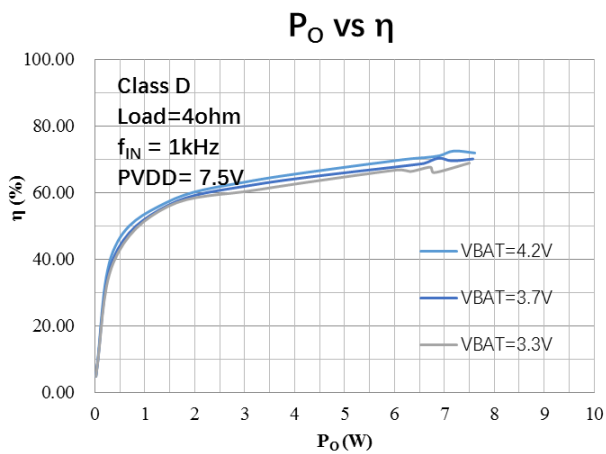
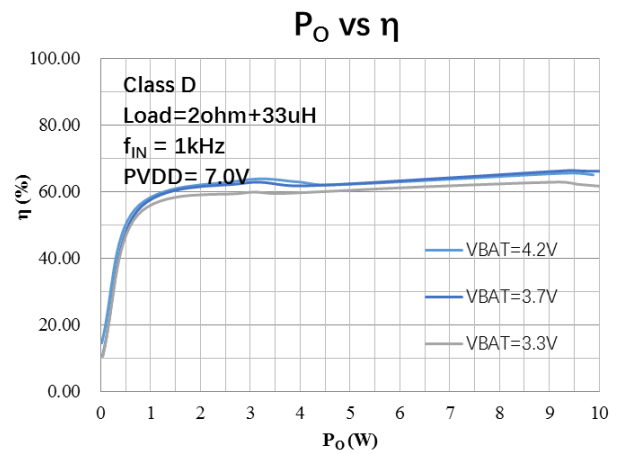
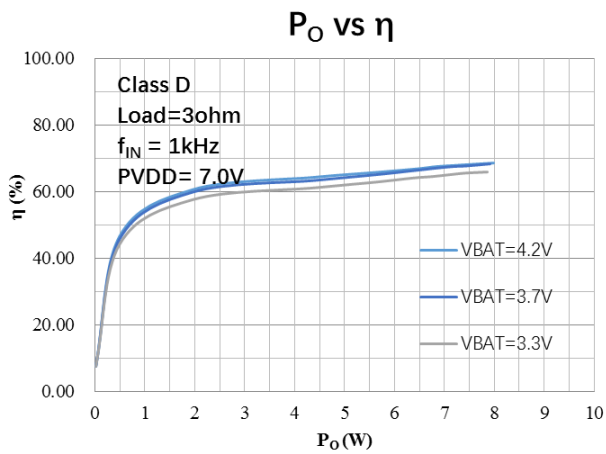
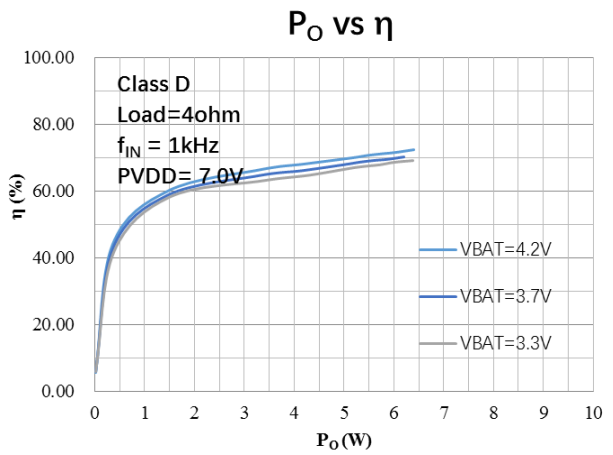
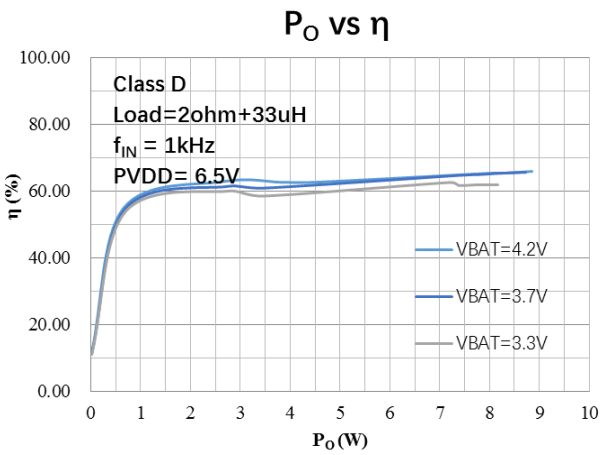
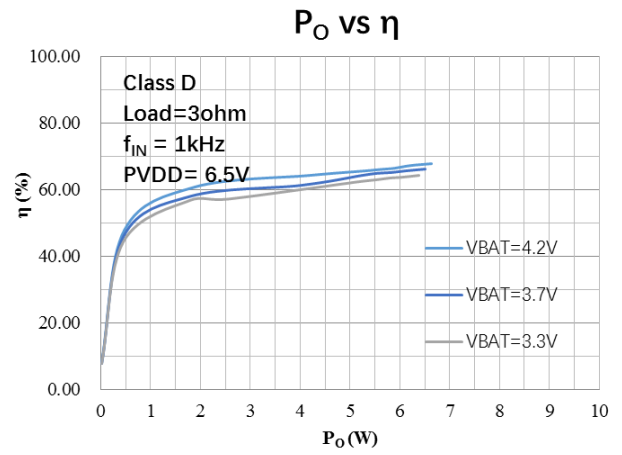
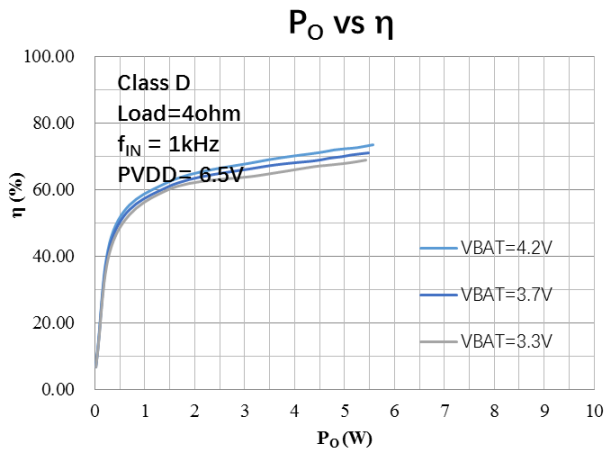

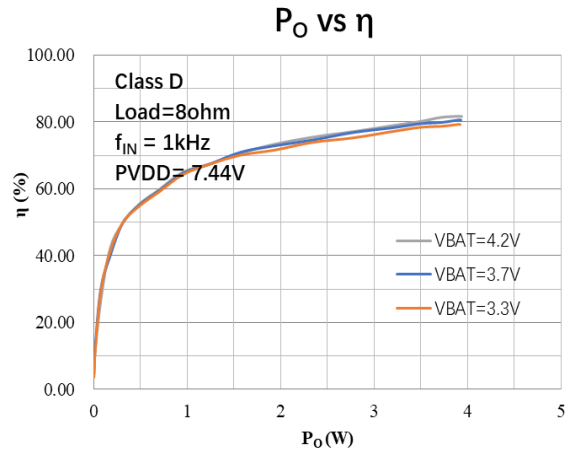
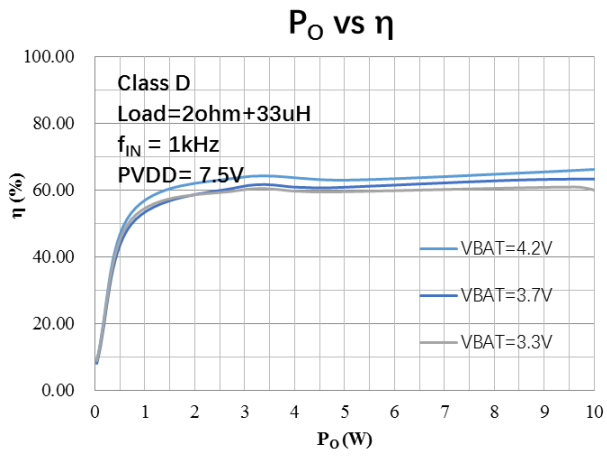

Class AB Channel

Condition: Class AB mode, $V_{BAT} = 3.7V$, $f_{IN} = 1kHz$, $C_{IN} = 2.2\mu F$, external $R_{IN} = 0\Omega$, Load = 4ohm, unless otherwise specified

Load = 4ohm

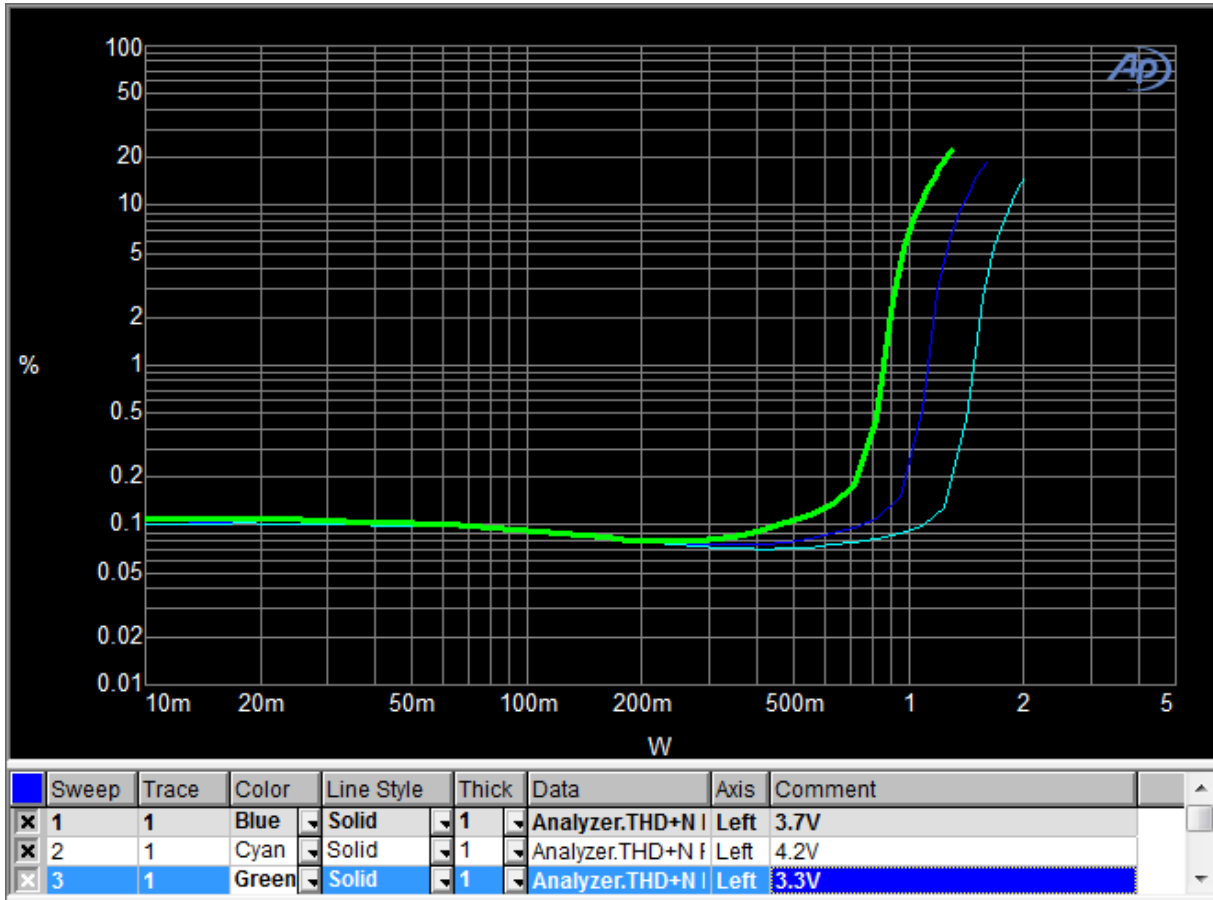

Output Power vs THD+N

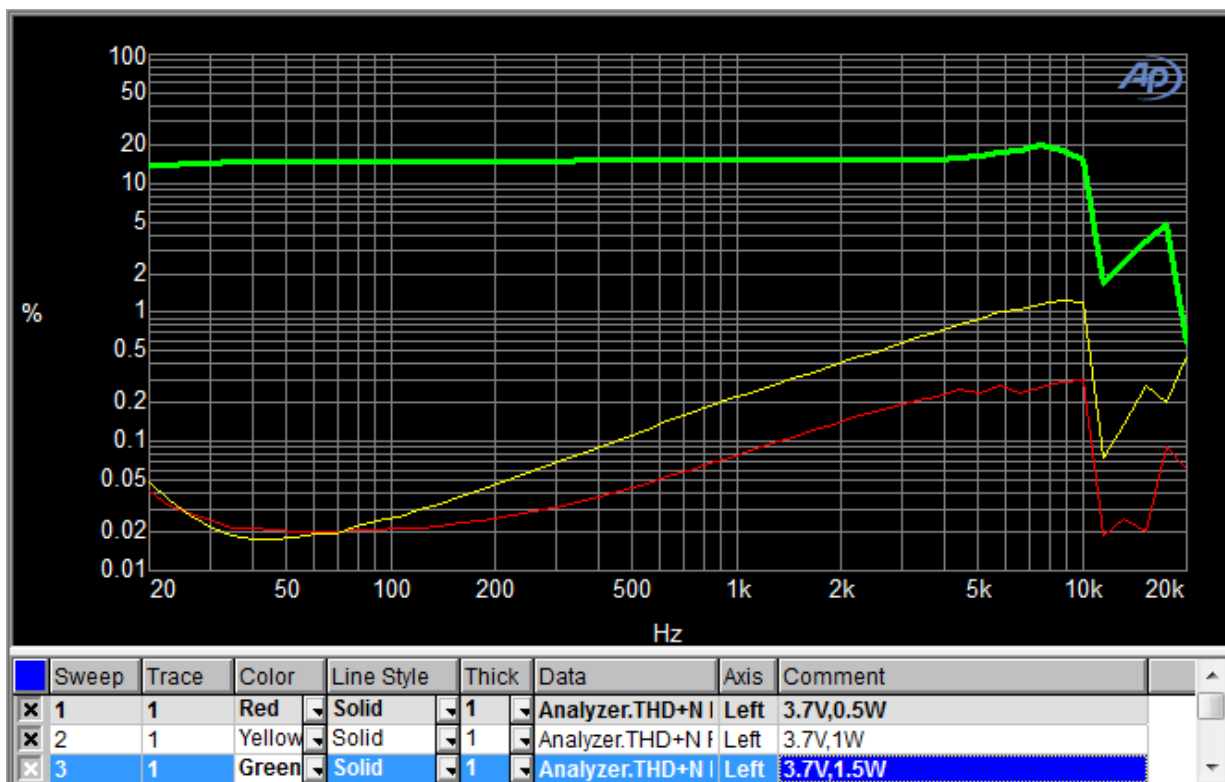

f_{IN} vs THD+N

Load = 3ohm

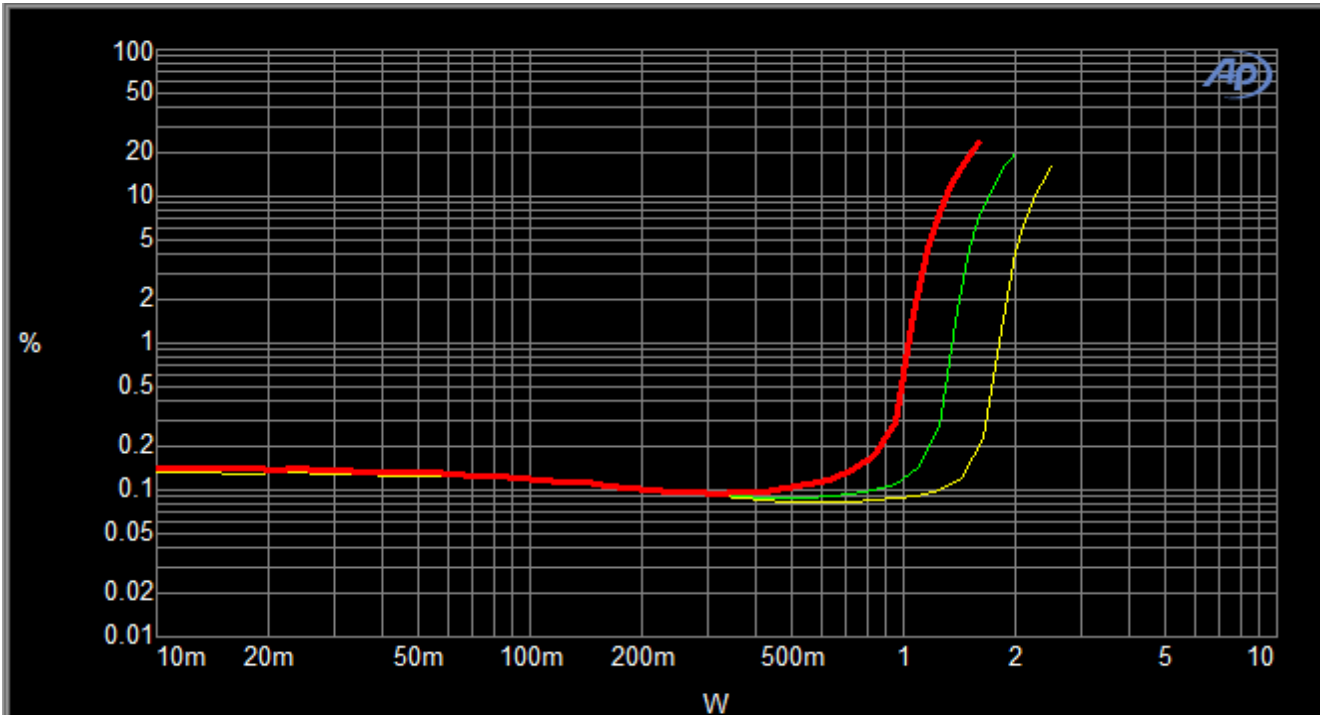

Sweep	Trace	Color	Line Style	Thick	Data	Axis	Comment
1	1	Green	Solid	1	Analyzer.THD+N Left	3.7V	
2	1	Yellow	Solid	1	Analyzer.THD+N Left	4.2V	
3	1	Red	Solid	1	Analyzer.THD+N Left	3.3V	

Output Power vs THD+N

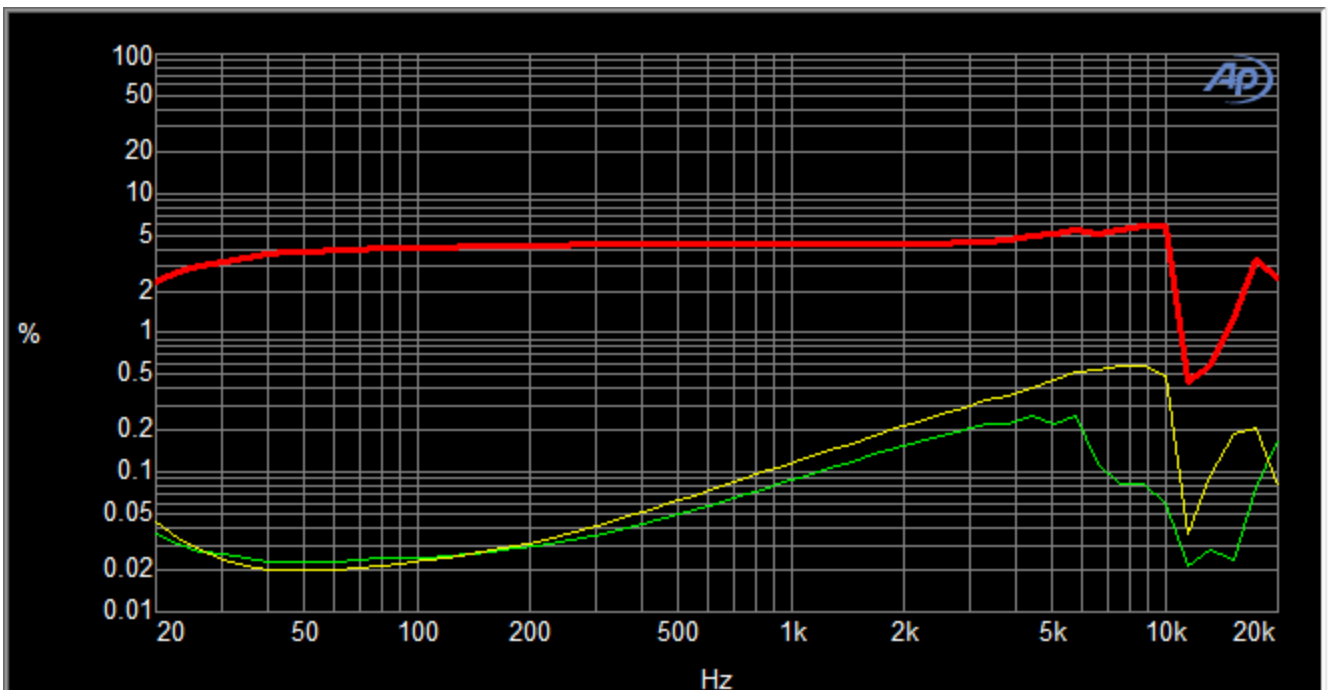

Sweep	Trace	Color	Line Style	Thick	Data	Axis	Comment
1	1	Green	Solid	1	Analyzer.THD+N Left	3.7V,0.5W	
2	1	Yellow	Solid	1	Analyzer.THD+N Left	3.7V,1W	
3	1	Red	Solid	1	Analyzer.THD+N Left	3.7V,1.5W	

f_{in} vs THD+N

Load = 2ohm+33uH

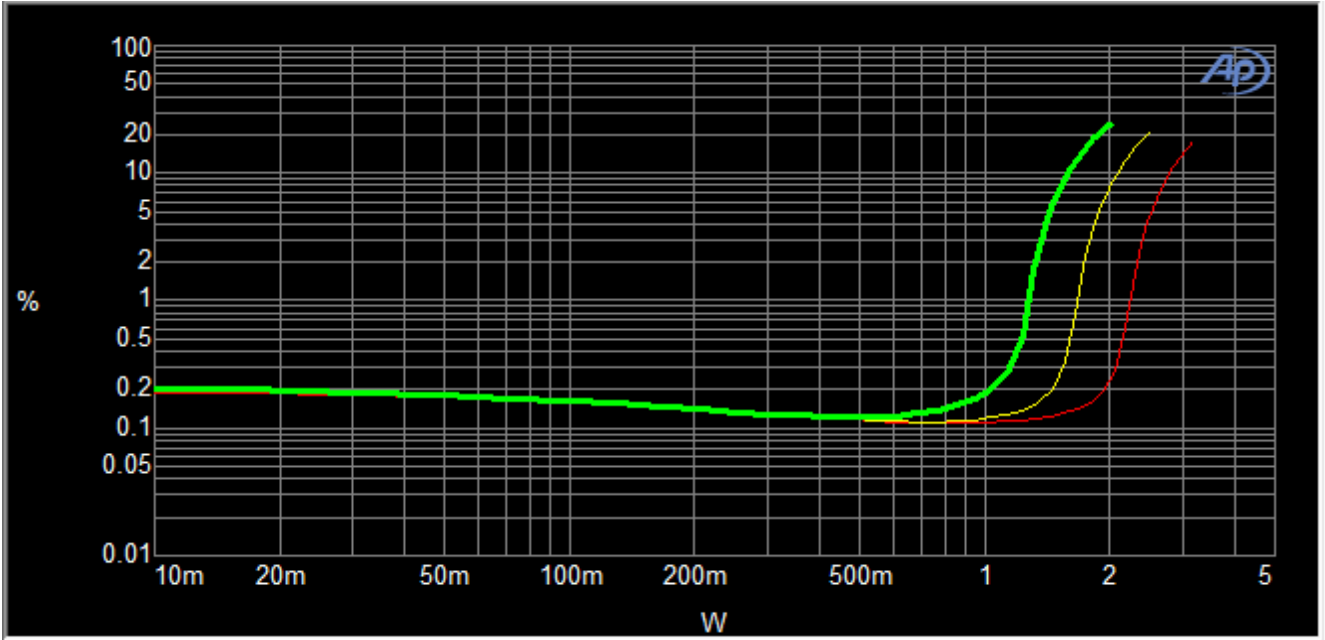

Sweep	Trace	Color	Line Style	Thick	Data	Axis	Comment
1	1	Red	Solid	1	Analyzer.THD+N	Left	4.2V
2	1	Yellow	Solid	1	Analyzer.THD+N	Left	3.7V
3	1	Green	Solid	1	Analyzer.THD+N	Left	3.3V

Output Power vs THD+N

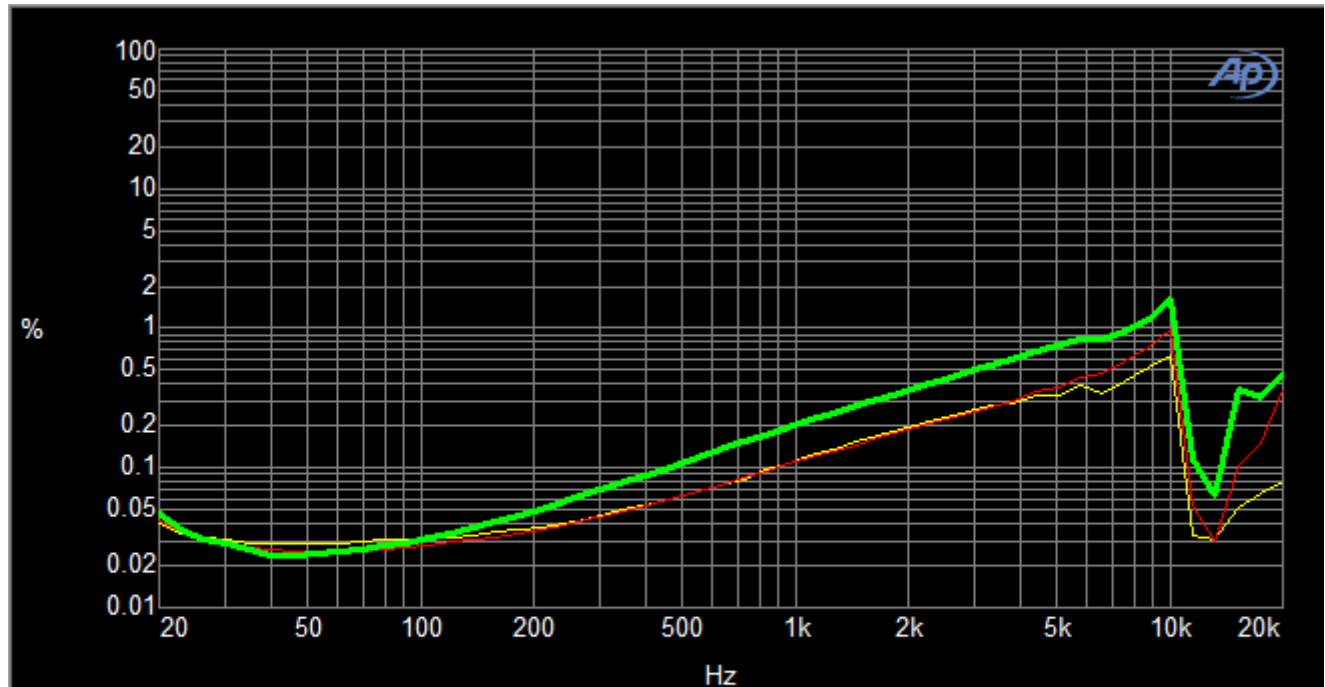

Sweep	Trace	Color	Line Style	Thick	Data	Axis	Comment
1	1	Yellow	Solid	1	Analyzer.THD+N	Left	3.7V,0.5W
2	1	Red	Solid	1	Analyzer.THD+N	Left	3.7V,1W
3	1	Green	Solid	1	Analyzer.THD+N	Left	3.7V,1.5W

f_{IN} vs THD+N

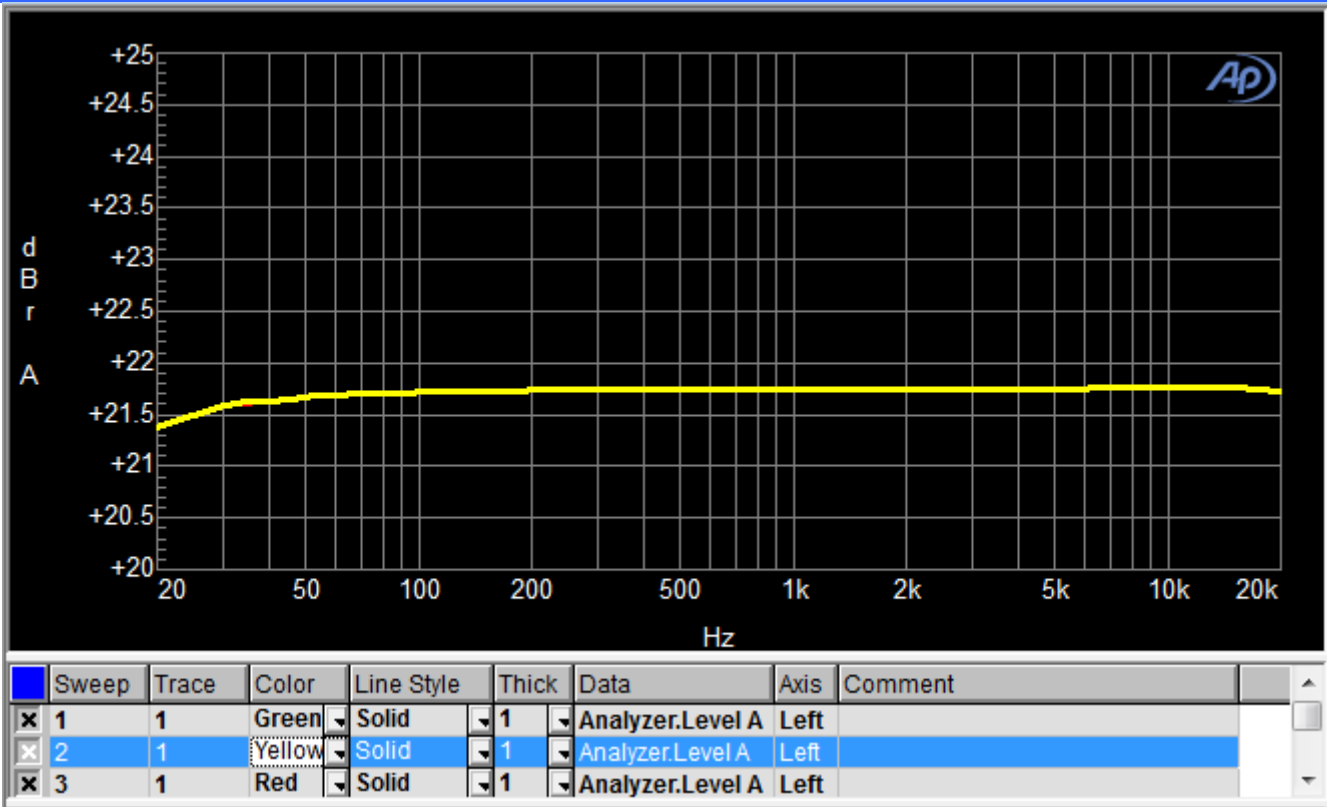

Frequency Respond ($R_{IN} = 0\text{ohm}$)

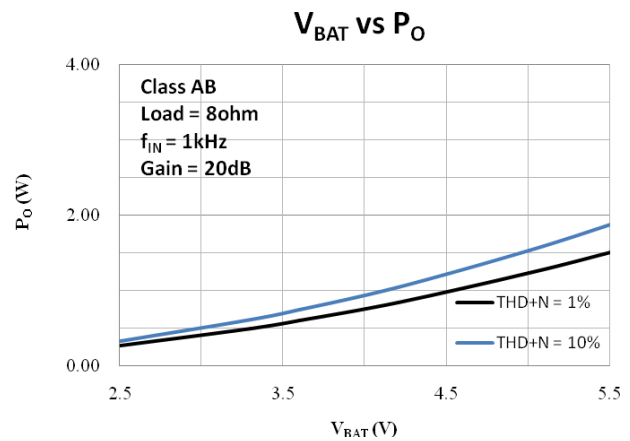
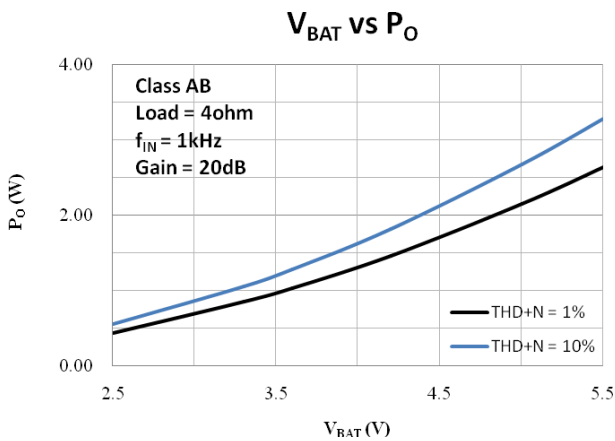
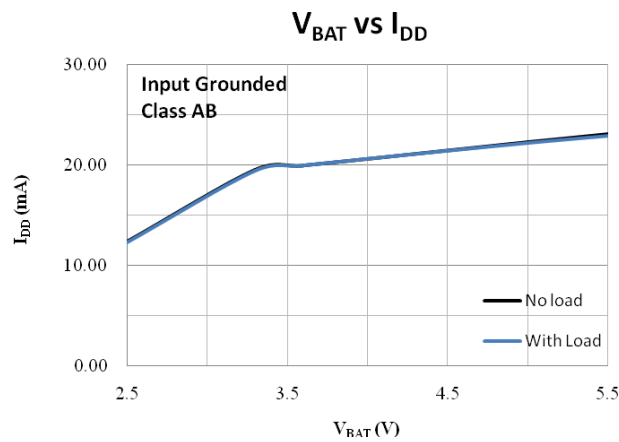

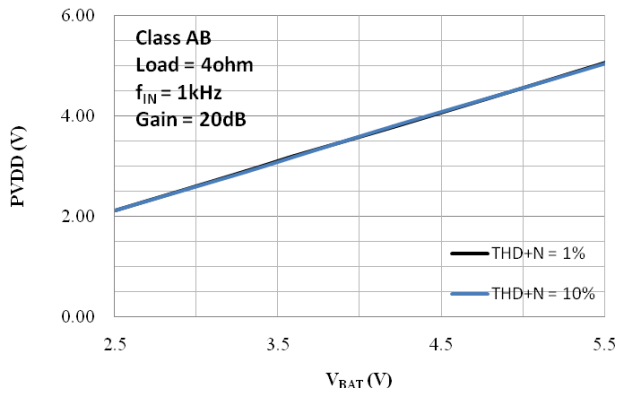
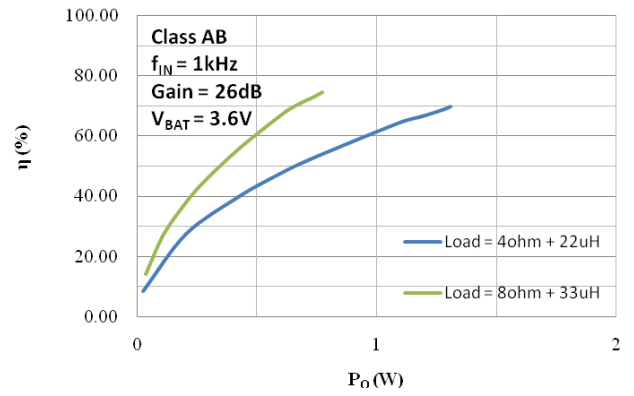
V_{BAT} vs P_{VDD}

 P_O vs η

APPLICATION INFORMATION

● BOOST Converter

(1) Setting Output Voltage

The output voltage is set by a resistive voltage divider from the output voltage to FB terminal, which is shown below. The output voltage can be calculated by $PVDD = 1.24 \cdot (Rd1 + Rd2) / Rd2$.

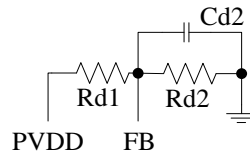

Fig. 1 FB Terminal Configuration

Some typical output voltages can be got by following settings.

Table 1. Output Voltage Setting

PVDD	Rd1	Rd2	Cd2
5.0V	510K	165K	3.3nF
6.5V	510K	120K	3.3nF
7.0V	510K	110K	3.3nF
7.5V	510k	100k	3.3nF

(2) LX Terminal

It is strongly recommended to place an RC circuit from the terminal of LX to Ground, shown as following, so that the ripple current of Boost Converter can be decreased. Meanwhile, the total consumption current of the system will be larger so that the efficiency of the system will be lower. Specifications in this file is measured under the condition with RC.

Notes: RC should be placed as closely to LX pin as possible.

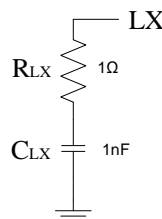

Fig. 2 LX Terminal Configuration

(3) Capacitor Selection

The input and output capacitor (C_{IN} and C_{OUT}) is required to maintain the DC voltage. Low ESR capacitors are preferred to reduce the output voltage ripple. 1uF//10uF//220uF (paralleled) is highly recommended to be placed in both input and output terminal as closely to the pin as possible. If possible, 470uF is better than 220uF.

(4) Inductor Selection

The inductor is selected based on different conditions. Normally, $L \geq 2.2\mu H$, $DCR < 1\Omega$, and **do make sure that I_{SAT} is higher than the maximum peak current of input power supply.**

(5) Schottky Diode Selection

$V_{RRM} > 12V$, $V_{FM} < 0.5V$, and **do make sure that I_F is higher than the maximum current of output power supply.**

(6) Layout Consideration

1. The power traces, consisting of the GND, LX, V_{BAT} and PVDD trace should be kept short, direct, wide, and as closely to the pin as possible. The switching node LX should be paid more attention for EMI and reliability consideration.
2. Place C_{IN} and C_{OUT} near V_{BAT} and PVDD as closely as possible to maintain voltage steady, and filter out the pulsing current.
3. The resistive divider R should be connected to pin directly as closely as possible. FB is a sensitive node. Please keep it away from switching node, LX.
4. The GND of the IC, C_{IN} and C_{OUT} should be connected close together directly to ground plane.

● Analog Signal Input Configuration

HT8691R is an amplifier with analog input (single-ended or differential). For a differential operation, input signals into IN+ and IN- pins via DC-cut capacitors (C_{IN}) and external input resistors R_{IN}. The input signal gain is calculated by $Gain \approx R_F / (External\ R_{IN} + Internal\ R_{IN})$. And the high pass cut-off frequency of input signal can be calculated by $f_c = \frac{1}{2\pi(External\ R_{IN} + Internal\ R_{IN}) \times C_{IN}}$.

For a single-ended operation, input signals to IN+ pin via a DC-cut capacitor (C_{IN}) and external input resistor (R_{IN}). IN- pin should be connected to ground via a DC-cut capacitor and external input resistor (R_{IN}) (with the same value of C_{IN} and R_{IN}). The Gain and high pass Cut-off frequency are the same as the above case.

Table. 2 Internal input resistors and feedback resistors

Working Mode	Internal R _{IN} (ohm)	R _F (ohm)
Class D mode	17.8k	450K
Class AB mode	17.8k	225K

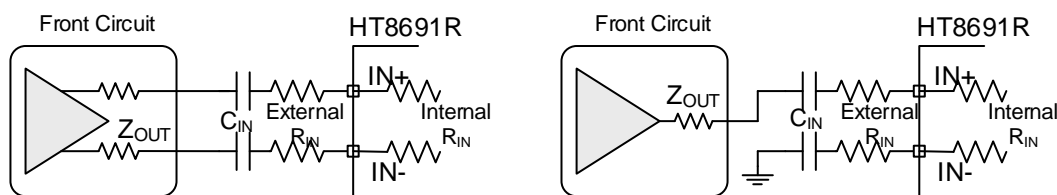

Fig. 3 (1) Differential Input;

(2) Single-ended Input

● Output Configuration

As mentioned, HT8691R can directly drive speakers without any other components. But there are exceptions. Once HT8691R works in class D mode, the cable lined to the speaker is very long, and EMI is concerned, ferrite beads or L-C filter is needed.

● CTRL Terminal Mode Control

HT8691R can work in different modes by setting the CTRL terminal, shown as follow.

Table. 3 CTRL Terminal Mode Control

MODE	SYMBOL	CTRL Voltage			
		MIN.	TYP.	MAX.	UNIT
Class D mode in ACF-Off with Boost Converter	V _{MOD1}	2.4		V _{BAT}	V
Class D mode in ACF-ON with Boost Converter	V _{MOD2}	1.6		2.2	V
Class AB mode in ACF-Off without Boost Converter	V _{MOD3}	0.4		1.4	V
SD(Shutdown) Mode	V _{MOD4}	V _{SS}		0.2	V

Notes: ACF-ON mode can only be worked in class D mode. A 300kΩ pull-down resistor are inside of the CTRL terminal, shown as follows.

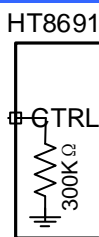

Fig. 4 CTRL Terminal

HT8691R can only be turned into operation from shutdown mode when the voltage of CTRL is higher than 0.8V (1.0V is recommended).

● **Anti-Clipping Function (ACF) and mode Configuration**

(1) ACF ON Mode

In ACF-ON modes, HT8691R attenuates system gain to an appropriate value when an excessive input is applied, so as not to cause the clipping at the differential signal output. In this way, the output audio signal is controlled in order to obtain a maximum output level without distortion. And HT8691R also follows to the clips of the output waveform due to the decrease in the power-supply voltage.

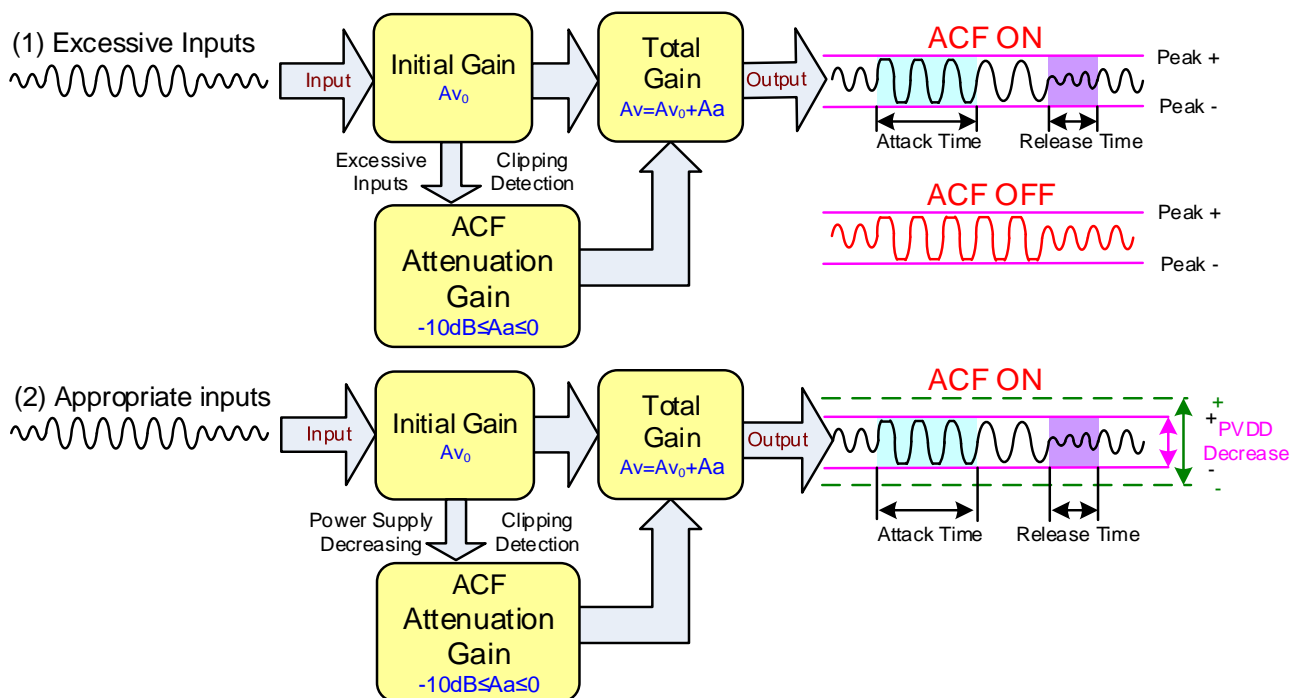

Fig. 5 the ACF Function Operation Outline

The Attack time of ACF Function is a time interval until system gain falls to target attenuation gain -3dB when a big enough signal input. And, the Release Time is a time from target attenuation gain to not working of ACF. The maximum attenuation gain is 16dB.

Table 4 Attack time and Release time

ACF mode	Attack time	Release time
ACF ON	50ms	64ms

(2) ACF OFF Mode

In ACF-Off mode, ACF function is disabled. HT8691R will not detect output clipping and the system gain is kept to be $A_v = A_{v0}$. The audio quality would worsen due to clipping distortion.

(3) Class AB mode

HT8691R works as Class AB audio Amplifier in ACF off mode, the boost converter is disabled.

(4) SD Mode

In shutdown mode, HT8691R shuts all circuit down and minimizes the power consumption. And, the output terminals become Weak Low (A high resistance grounded state).

● Pop-Click Noise Reduction

The Pop-Click Noise Reduction Function of HT8691R works in the cases of Power-on, Power-off, Shutdown on, and Shutdown off. To achieve a more excellent noise reduction performance, it is recommended to use a DC-cut capacitor (C_{IN}) of 0.1 μ F or less.

Besides, POP noise can be minimal according to the following procedure of shutdown control.

- During power-on, Shutdown mode is not cancelled until the power supply is stabilized enough.
- Before Power-off, set Shutdown mode first.

The pop-click noise: Power-on/-off > Shutdown on/off.

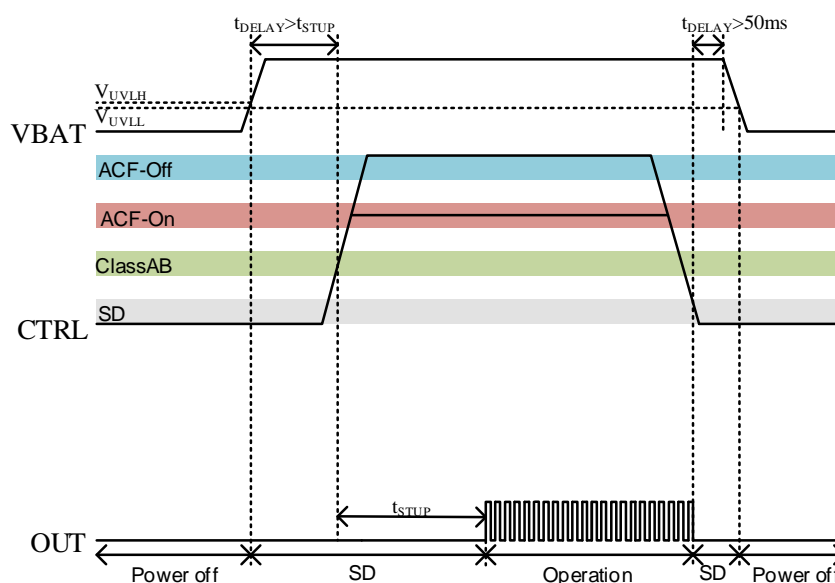

Fig. 6 Pop-Click Noise Reduction by Shutdown

● Protection Function

HT8691R has the protection functions such as Over-Current Protection function, Thermal Protection function, and Low Voltage Malfunction Prevention function.

(1) Over-current Protection function

When a short circuit occurs between one output terminal and Ground, PVDD, or the other output, the over-current protection mode starts up. In the over current protection mode, the differential output terminal becomes a high impedance state. Once the short circuit conditions are eliminated, the over current protection mode can be cancelled automatically.

(2) Thermal Protection function

When excessive high temperature of HT8691R (150°C) is detected, the thermal protection mode starts up. In the thermal protection mode, the differential output terminal becomes Weak Low state (a state grounded through high impedance).

(3) Low voltage Malfunction Prevention function

This is the function to establish the low voltage protection mode when PVDD terminal voltage becomes lower than the detection voltage (V_{UVLL}) for the low voltage malfunction prevention. And the protection mode is canceled when PVDD terminal voltage becomes higher than the threshold voltage (V_{UVLH}). In the low voltage protection mode, the differential output pin becomes Weak Low state (a state grounded through high impedance). HT8691R will start up within the start-up time (T_{STUP}) when the low voltage protection mode is cancelled

● PCB Layout

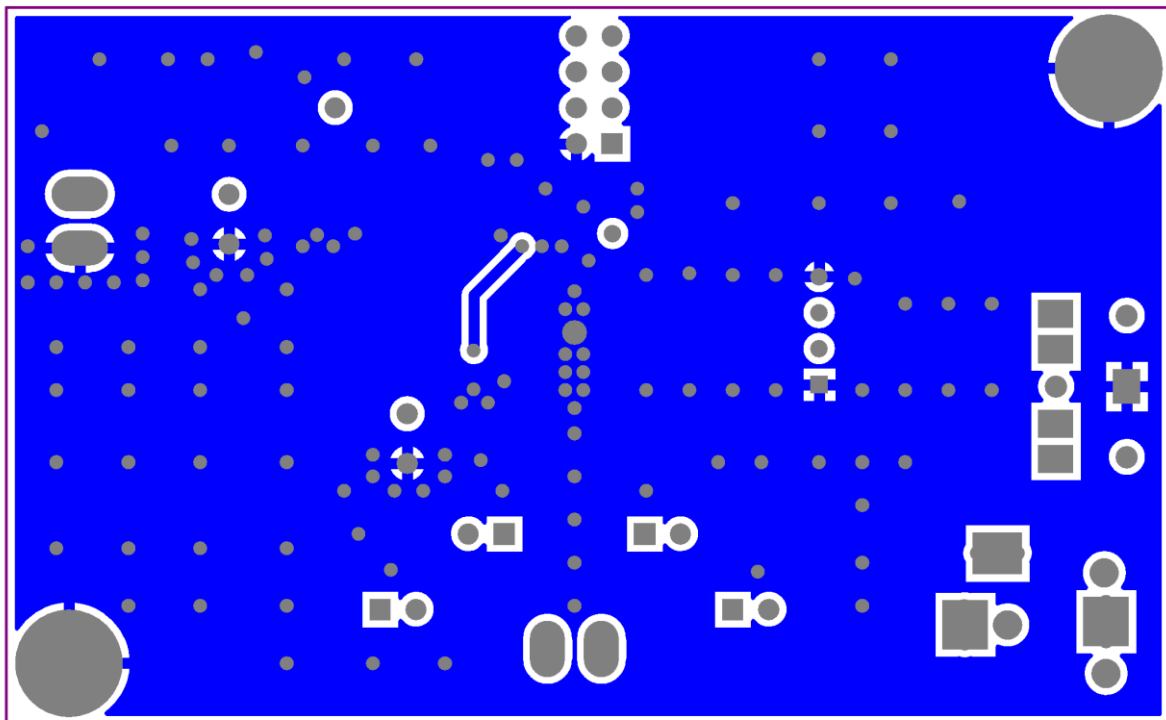
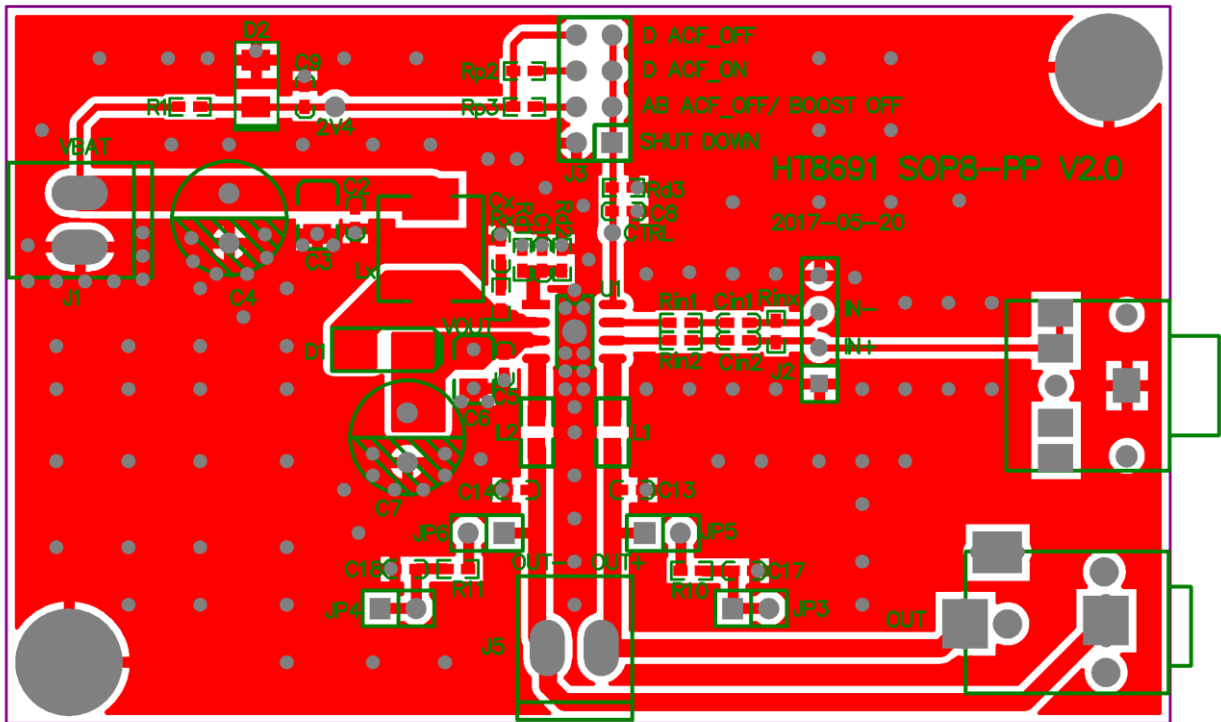

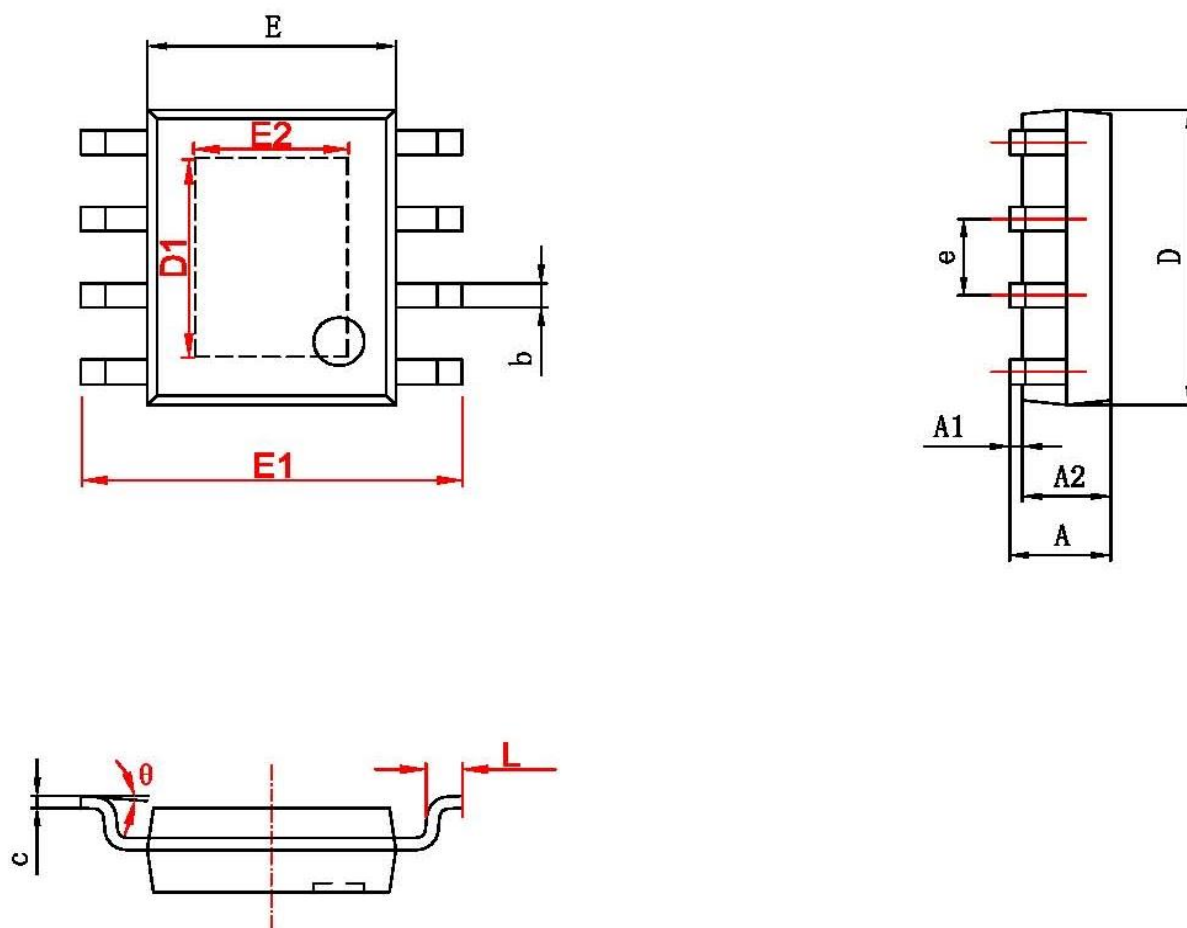
PACKAGE OUTLINE
SOP8-PP(EXP PAD) PACKAGE OUTLINE DIMENSIONS

字符	Dimensions In Millimeters		Dimensions In Inches	
	Min	Max	Min	Max
A	1.350	1.750	0.053	0.069
A1	0.050	0.150	0.002	0.006
A2	1.350	1.550	0.053	0.061
b	0.330	0.510	0.013	0.020
c	0.170	0.250	0.007	0.010
D	4.700	5.100	0.185	0.200
D1	3.202	3.402	0.126	0.134
E	3.800	4.000	0.150	0.157
E1	5.800	6.200	0.228	0.244
E2	2.313	2.513	0.091	0.099
e	1.270 (BSC)		0.050 (BSC)	
L	0.400	1.270	0.016	0.050
θ	0°	8°	0°	8°

IMPORTANT NOTICE

注意

Jiaxing Heroic Electronic Technology Co., Ltd (HT) reserves the right to make corrections, modifications, enhancements, improvements, and other changes to its products and services at any time and to discontinue any products or services. Customers should obtain the latest relevant information before placing orders and should verify that such information is current and complete.

嘉兴禾润电子科技有限公司（以下简称HT）保留对产品、服务、文档的任何修改、更正、提高、改善和其他改变，或停止提供任何产品和服务的权利。客户在下单和生产前应确保所得到的信息是最新、最完整的。

HT assumes no liability for applications assistance or customer product design. Customers are responsible for their products and applications using HT components.

HT对相关应用的说明和协助以及客户产品的板级设计不承担任何责任。

HT products are not authorized for use in safety-critical applications (such as life support devices or systems) where a failure of the HT product would reasonably be expected to affect the safety or effectiveness of that devices or systems.

HT的产品并未授权用于诸如生命维持设备等安全性极高的应用中。

The information included herein is believed to be accurate and reliable. However, HT assumes no responsibility for its use; nor for any infringement of patents or other rights of third parties which may result from its use.

本文中的相关信息是精确和可靠的，但HT并不对其负责，也不对任何可能的专利和第三方权利的侵害负责。

Following are URLs and contacts where you can obtain information or supports on any HT products and application solutions:

下面是可以联系到我公司的相关链接和联系方式：

嘉兴禾润电子科技有限公司

Jiaxing Heroic Electronic Technology Co., Ltd.

地址：浙江省嘉兴市凌公塘路3339号JRC大厦A座三层

Add: A 3rd floor, JRC Building, No. 3339, LingGongTang Road, Jiaxing, Zhejiang Province

Sales: 0573-82585539, sales@heroic.com.cn

Support: 0573-82586151, support@heroic.com.cn

Fax: 0573-82585078

Website: www.heroic.com.cn; wap.heroic.com.cn

Wechat MP: HEROIC_JX

请及时关注禾润官方微信公众号，随时获取最新产品信息和技术资料！

