

内置BOOST升压和防破音功能的9.0W D/AB类音频功率放大器

■ 特点

- 防削顶失真功能(防破音, Anti-Clipping Function, ACF)
- 免滤波器数字调制, 直接驱动扬声器
- 输出功率
 - 3.0W ($V_{BAT}=4.2V$, $PVDD = 6.5V$, $R_L=8\Omega$, $THD+N=10\%$)
 - 5.5W ($V_{BAT}=4.2V$, $PVDD = 6.5V$, $R_L=4\Omega$, $THD+N=10\%$)
 - 9.0W ($V_{BAT}=4.2V$, $PVDD = 7.5V$, $R_L=3\Omega$, $THD+N=10\%$)
- 电源
 - 升压输入 V_{BAT} : 2.5V至5.5V
 - 升压输出 $PVDD$: V_{BAT} 至7.5V
- BOOST输出电压可调
- AB/D类可切换
- 保护功能:过流/过热/欠压异常保护功能
- 无铅封装, SOP8L-PP

■ 应用

- | | |
|---|--|
| <ul style="list-style-type: none"> · 蓝牙音箱 · 2.1声道小音箱 · iphone/ipod/ipod docking · 平板电脑, 笔记本电脑 · 小尺寸LCD电视/监视器 | <ul style="list-style-type: none"> · 便携式音箱 · 扩音器 · MP4, 导航仪 · 智能手机 · 便携式游戏机 |
|---|--|

■ 典型应用图

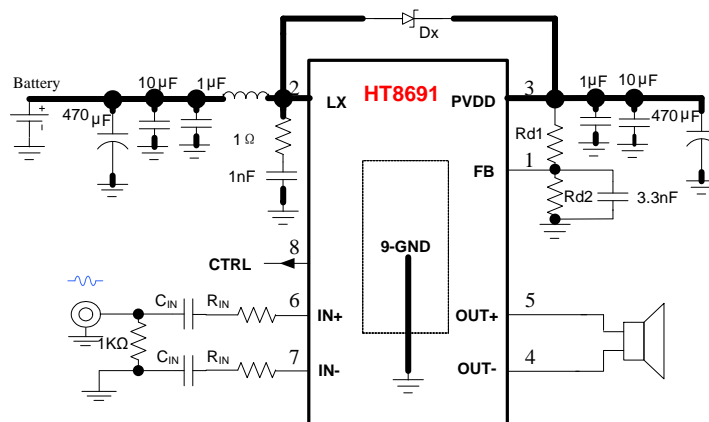

■ 概述

HT8691是一款内置BOOST升压模块的D类音频功率放大器。内置的BOOST升压模块可通过外置电阻调节升压值,即使是锂电池供电,在升压至6.5V时,10% THD+N, 4Ω负载条件下能连续输出5.5 W功率;升压至7.5V, 3Ω负载条件下则能连续输出9.0W功率。其支持外部设置调节BOOST输出电压。

HT8691的最大特点是防削顶失真 (ACF) 输出控制功能,可检测并抑制由于输入音乐、语音信号幅度过大所引起的输出信号削顶失真 (破音),也能自适应地防止在BOOST升压电压下降所造成的输出削顶,显著提高音质,创造非常舒适的听音享受,并保护扬声器免受过载损坏。同时芯片具有ACF-Off 模式。

HT8691具有AB类和D类的自由切换功能,在受到D类功放EMI干扰困扰时,可随时切换至AB类音频功放模式。

HT8691内部集成免滤波器数字调制技术,能够直接驱动扬声器,并最大程度减小脉冲输出信号的失真和噪音。输出无需滤波网络,极少的外部元器件节省了系统空间和成本,是便携式应用的理想选择。

此外, HT8691内置的关断功能使待机电流最小化,还集成了输出端过流保护、片内过温保护和电源欠压异常保护等功能。

9.0W Anti-Clipping Mono Class D/AB Audio Amplifier with Boost Converter

■ FEATURE

- Anti-Clipping Function (ACF)
- Filter-less Modulation, Eliminating Output Filter
- Output Power
 - 3.0W (VBAT=4.2V, PVDD = 6.5V, RL=8Ω, THD+N=10%)
 - 5.5W (VBAT=4.2V, PVDD = 6.5V, RL=4Ω, THD+N=10%)
 - 9.0W (VBAT=4.2V, PVDD = 7.5V, RL=3Ω, THD+N=10%)
- Power Supply
 - Boost Input V_{BAT}: 2.5V to 5.5V
 - Boost Output PVDD: V_{BAT} to 7.5V
- Adjustable BOOST Output Voltage
- Class AB / Class D
- Over Current Protection, Thermal Protection, Low voltage malfunction prevention function included
- Pb-Free Packages , SOP8L-PP

■ APPLICATIONS

- | | |
|----------------------------|---------------------|
| • Bluetooth Speakers | • Portable Speakers |
| • 2.1 Channel Speakers | • Megaphone |
| • iphone/ipod/ipod docking | • MP4/GPS |
| • Tablet PC/Note Book | • Smart Phones |
| • LCD TV/Monitor | • Portable Gamers |

■ GENERAL DESCRIPTION

HT8691 integrates a boost converter with a filter-less stereo class D audio power amplifier to provide 5.5W continuous power into a 4Ω speaker when operating from a Li-battery voltage boosted to 6.5V, and 9.0W continuous power into a 3Ω speaker when operating from a Li-battery voltage boosted to 7.5V. Meanwhile, the boost output voltage is adjustable.

HT8691 features Anti-Clipping Function (ACF) which detects output signal clip due to the over input signal and suppresses the output signal clip automatically. Also, the ACF function can adapt the output clip caused by power supply voltage down with battery. It can significantly improve the sound quality, creating a very comfortable musical enjoyment, and to protect the speakers from overload damage. It also supplies ACF OFF mode.

Class AB amplifier mode is also available for HT8691. Once the EMI Interference from class D and Boost Converter becomes an annoying problem, HT8691 can be changed into Class AB mode.

HT8691 has a filter-less modulation circuit which directly drives speakers while realizes low distortion and low noise characteristics. Thanks to filter-less, circuit design with fewer external parts can be made in portable applications.

HT8691 has the independent Shutdown function which can minimize the power consumption at standby and MUTE function. As for protection function, over current protection function for speaker output terminals, over temperature protection function, and low supply voltage malfunction preventing function are also prepared.

■ TYPICAL APPLICATION

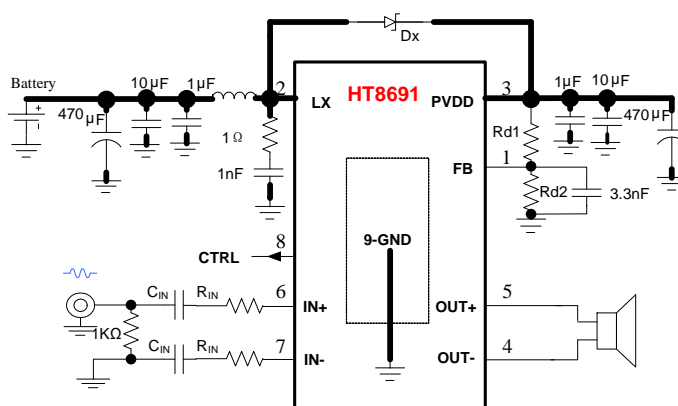

■ TERMINAL CONFIGURATION

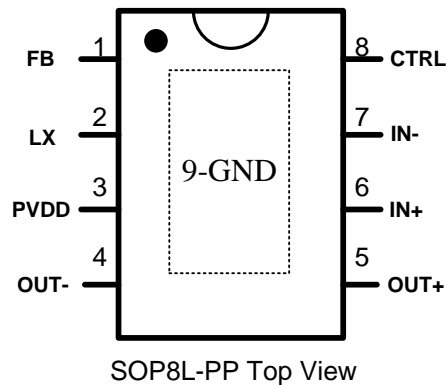

■ TERMINAL FUNCTION ¹

SOP Terminal No.	Name	I/O	ESD Protection	Function
1	FB	I	PN	Regulator Feedback Input
2	LX	I	-	Internal Switch Input
3	PVDD	Power	PN	Boost Converter Output Voltage and Power Supply
4	OUT-	O	-	Negative Output Terminal (BTL-)
5	OUT+	O	-	Positive Output (BTL+)
6	IN+	I	PN	Positive Input Terminal (differential +)
7	IN-	I	PN	Negative Input Terminal (differential -)
8	CTRL	I	PN	Shutdown and ACF Control Terminal
9	GND ²	GND	PN	Power Ground

■ ORDERING INFORMATION

Part Number	Package Type	Marking	Operating Temperature Range	MOQ/Shipping Package
HT8691Q5SPET	SOP8L-PP	HT8691SP	-40°C~85°C	Tube /100PCS
HT8691Q5SPER	SOP8L-PP	HT8691SP	-40°C~85°C	Tape and Reel 2500PCS

¹ I: Input O: Output

² Do make sure that the GND pin is grounded into the Ground plane connecting into the power ground.

● ELECTRICAL CHARACTERISTIC

● Absolute Maximum Ratings¹

Item	Symbol	Min.	Max.	Unit
BOOST converter output voltage and Power supply voltage range	PVDD	-0.3	7.8	V
Input terminal voltage range (IN+, IN-)	V _{IN}	-0.6	PVDD+0.6	V
Input terminal voltage range (except IN+, IN-)	V _{IN}	-0.3	PVDD+0.3	V
Operating Ambient Temperature	T _A	-40	85	°C
Junction Temperature	T _J	-40	150	°C
Storage Temperature	T _{STG}	-50	150	°C

● Recommended Operating Condition

Item	Symbol	Conditions	Min.	Typ.	Max.	Unit
BOOST converter output voltage and Power supply voltage range ²	PVDD		V _{BAT}	6.5	7.5	V
Operating Ambient Temperature	T _a		-40	25	85	°C
Speaker Impedance	R _L	SOP8L-PP		4		Ω

● Electrical Specification³

Item	Symbol	Conditions	Min.	Typ.	Max.	Unit
BOOST Converter						
Boost converter output voltage	PVDD		V _{BAT}	6.5	7.5	V
Boost converter frequency	f _{SW}			410		kHz
Boost converter input current limit	I _{LIMTRIP}			4.6		A
Class D Channel V _{SS} =0V, V _{BAT} =3.6V, external R _{IN} = 56K, T _a =25°C, C _{IN} =1uF, ACF-Off mode, unless specified.						
Carrier clock frequency	f _{PWM}			410		kHz
Over current protection	I _{max}				5	A
System Gain	A _{V0}	External R _{IN} =56 kΩ		26		dB
Start-up time (power-on or shutdown release)	t _{STUP}			280		ms
ACF attenuation gain	A _a		-16		0	dB
Consumption current in shutdown mode	I _{SD}	CTRL=V _{SS}		25		μA
PVDD = 6.5V						
Output Power	P _o	R _L =4Ω	V _{BAT} =4.2V, f=1kHz, THD+N=10%		5.5	W
		R _L =3Ω, PVDD=7.5V			9.0	
		R _L =8Ω			3.1	
		R _L =4Ω	V _{BAT} =4.2V, f=1kHz, THD+N=1%		4.4	
		R _L =3Ω, PVDD=7.5V			8.0	
		R _L =8Ω			2.5	
Total Harmonic Distortion plus Noise	THD+N	P _o =1.0W, R _L =4Ω, f=1kHz		0.10		%
Output Noise	V _N	f=20Hz~20kHz, A weighted, A _v =26dB		150		μV _{rms}
Signal to Noise Ratio	SNR	A weighted, A _v =26dB, THD+N = 1%		90		dB
Output offset voltage	V _{OS}			±2		mV

¹ Absolute Maximum Ratings is values which must not be exceeded to guarantee device reliability. With a system in which supply voltage might exceed supply voltage of PVDD/GND, external diodes are recommended to be used to assure that the voltage does not exceed the absolute maximum rating

² The rising time of PVDD should be more than 1μs.

³ Depending on parts and pattern layout, characteristics may be changed.

Efficiency (Class D + Boost)	η	$V_{BAT}=3.6V, R_L=4\Omega+22\mu H,$ THD+N = 10%		75		%
		$V_{BAT}=3.6V, R_L=8\Omega+33\mu H,$ THD+N = 10%		80		%
Quiescent current	I_{BAT}	No Load	Input Grounded	20		mA
		With Load ¹		20		mA
Maximum Input Signal	V_{INmax}	$f_{IN} = 1kHz, THD+N \leq 10\%, ACF$ ON		1.2		V _{rms}
Class AB Channel ² $V_{SS}=0V, V_{BAT} = 3.6V, A_v=20dB, T_a=25^\circ C, C_{IN}=0.1\mu F,$ unless otherwise specified						
Output Power	P_O	$R_L=4\Omega,$ $V_{BAT}=3.6V$	$f=1kHz,$ THD+N=10%	1.3		W
		$R_L=4\Omega,$ $V_{BAT}=4.2V$		1.8		
		$R_L=4\Omega,$ $V_{BAT}=5.0V$		2.65		W
		$R_L=4\Omega,$ $V_{BAT}=3.6V$	$f=1kHz,$ THD+N=1%	1.0		W
		$R_L=4\Omega,$ $V_{BAT}=4.2V$		1.5		
		$R_L=4\Omega,$ $V_{BAT}=5.0V$		2.1		W
Total Harmonic Distortion plus Noise	THD+N	$P_O=0.01W$	$R_L=4\Omega,$ $f=1kHz$	0.12		%
		$P_O=0.1W$		0.1		%
Output Noise	V_N	$f=20Hz\sim 20kHz, A$ weighted, $A_v=20dB$		75		μV_{rms}
Signal to Noise Ratio	SNR	A weighted, $A_v=20dB, THD+N$ = 1%		90		dB
Output offset voltage	V_{OS}			± 4		mV
Efficiency	η	$R_L=4\Omega+22\mu H, THD+N = 10\%$		70		%
		$R_L=8\Omega+33\mu H, THD+N = 10\%$		74.5		%
Quiescent current	I_{BAT}	No Load	Input Grounded	20		mA
		With Load		20		mA
System Gain	A_{V0}	External $R_{IN}=56k\Omega$		20		dB
Start-up time (power-on, shutdown release, or switch from Class D to Class AB)	t_{STUP}			280		ms
CTRL Terminal						
ACF Off (Class D, Boost On) mode setting threshold voltage	V_{MOD1}			1.5	1.7	PVDD V
ACF ON (Class D, Boost On) mode setting threshold voltage	V_{MOD2}			0.91	1.1	1.2 V
ACF Off (Class AB, Boost Off) mode setting threshold voltage ³	V_{MOD3}			0.4	0.6	0.75 V
SD mode setting threshold voltage	V_{MOD4}			0	0	0.28 V
SD wake up voltage	V_{CTRL_ON}			0.8	1.0	V
Internal pull-down Resistor of CTRL	R_{CTRL}				300	K Ω
MISCELLANEOUS						
V_{BAT} start-up threshold voltage	V_{UVLH}				2.5	V
V_{BAT} shut-down threshold voltage	V_{UVLL}					2.0 V

¹ 4ohm resistor and 22uH coil are used as an output load in order to simulate a speaker.

² In Class AB amplifier mode, boost converter is shutdown automatically. Due to the schottky rectifier, the voltage of PVDD terminal can be lower than V_{BAT} , depending on the forward voltage of the rectifier V_F .

³ ACF ON mode is only available in Class D amplifier mode.

TYPICAL OPERATING CHARACTERISTICS

Class D Channel

Condition: Class D mode, $V_{BAT} = 3.6V$, $PVDD = 6.5V$, $f_{IN} = 1kHz$, $R_{IN} = 56k$, Gain = 26dB, ACF off, Load = 4ohm, unless otherwise specified

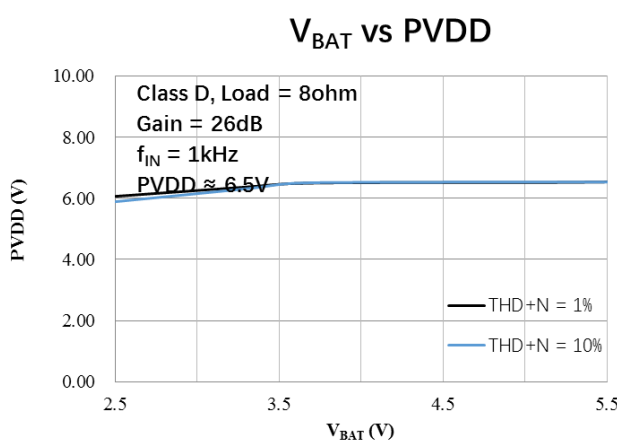
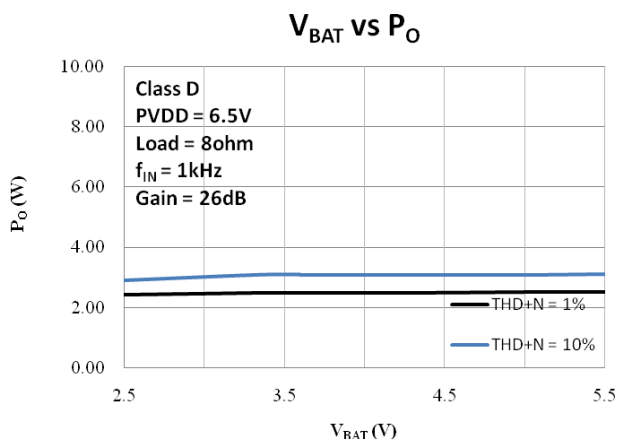
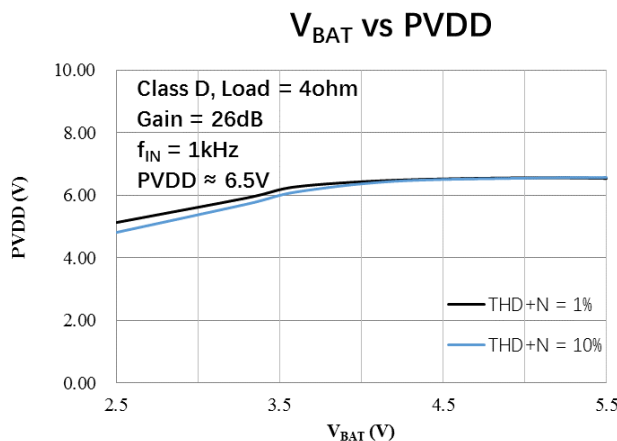
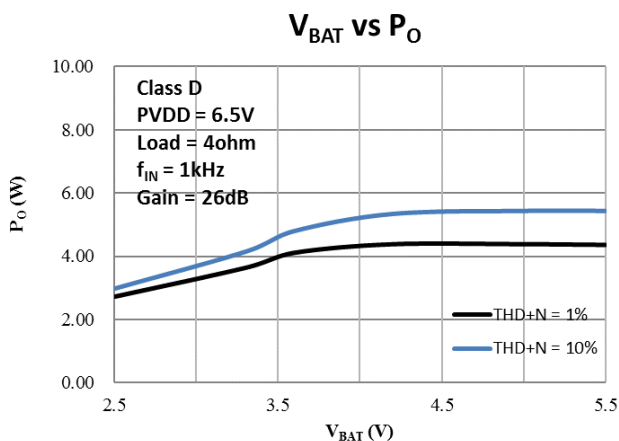
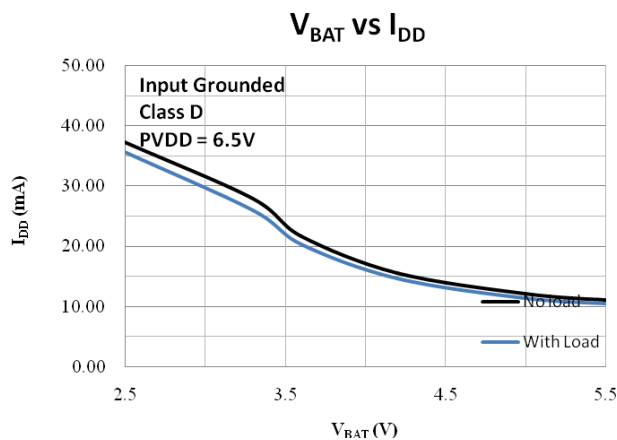
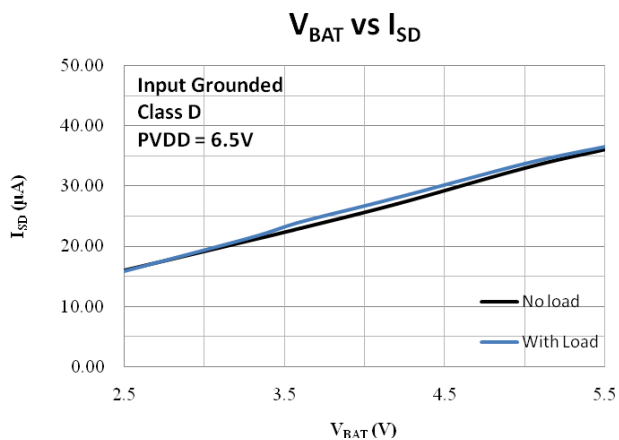

P_O vs THD+N

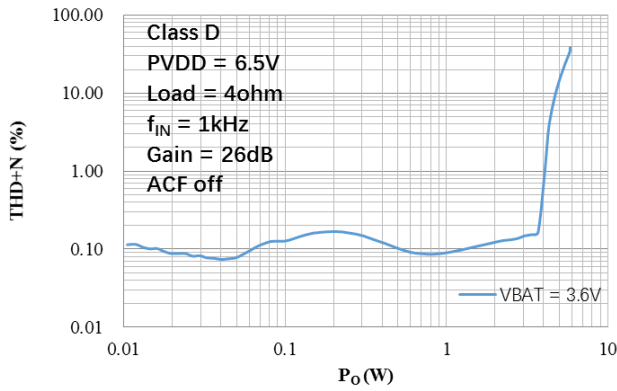

V_{IN} vs V_{OUT}

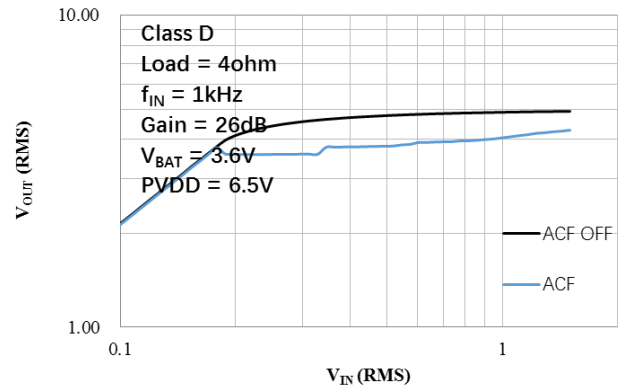

V_{IN} vs THD+N

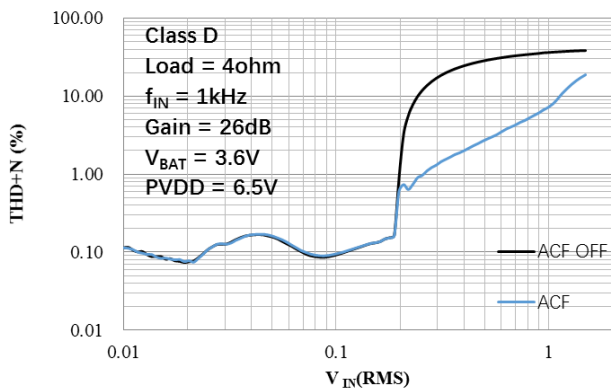

f_{IN} vs THD+N

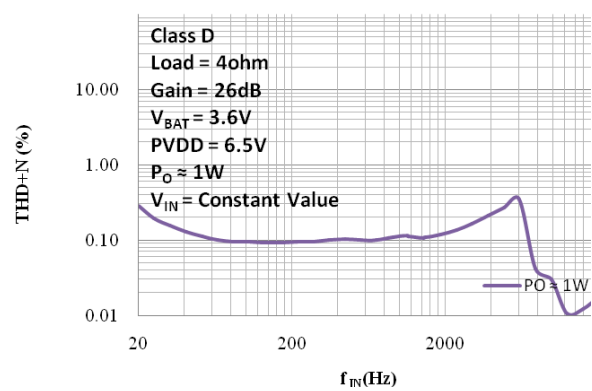

f_{IN} vs Gain

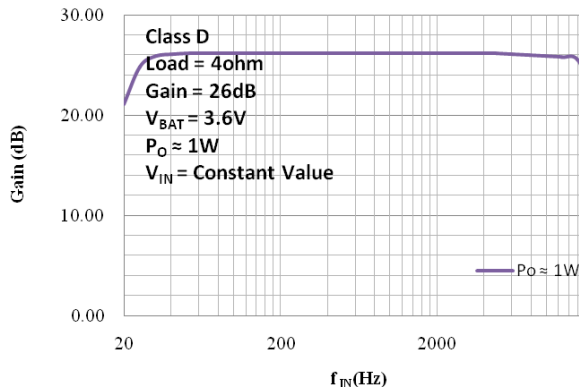

P_O vs η

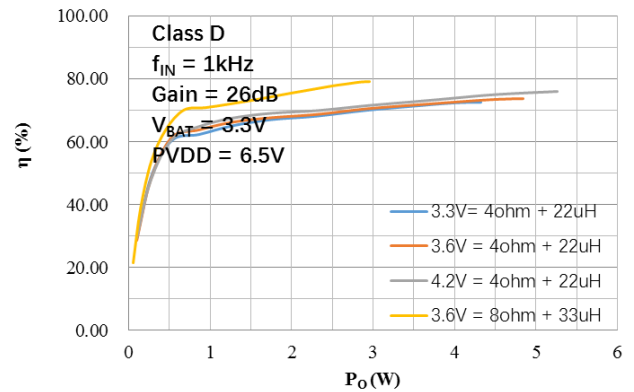

Class AB Channel

Condition: Class AB mode, $V_{BAT} = 3.6V$, $f_{IN} = 1kHz$, $R_{IN} = 56k$, Gain = 20dB, Output = Load = 4ohm, unless otherwise specified

V_{BAT} vs I_{DD}

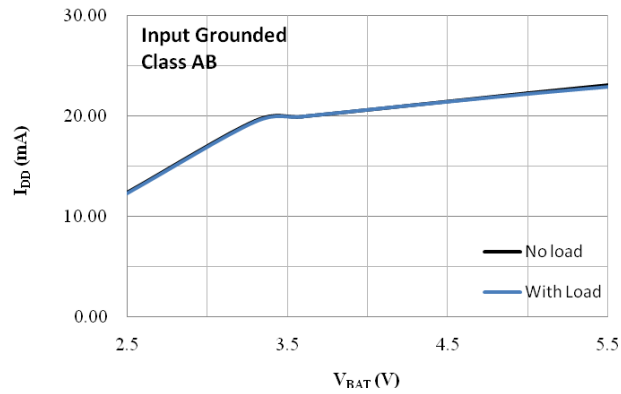

V_{BAT} vs P_O

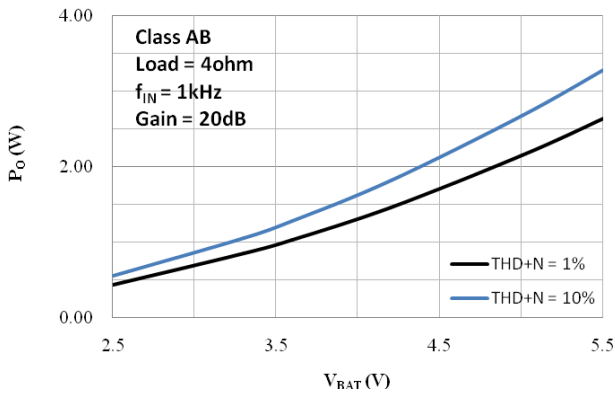

V_{BAT} vs P_O

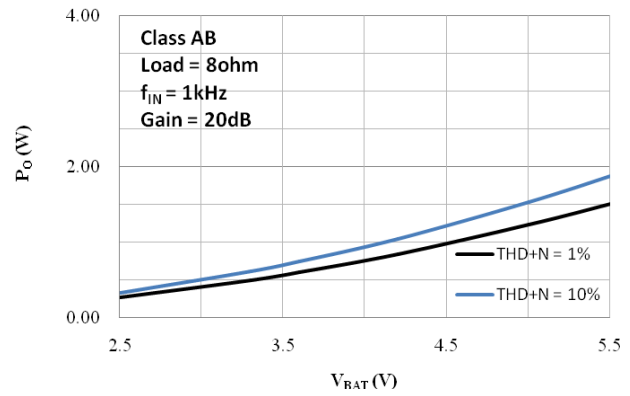

V_{BAT} vs P_{VDD}

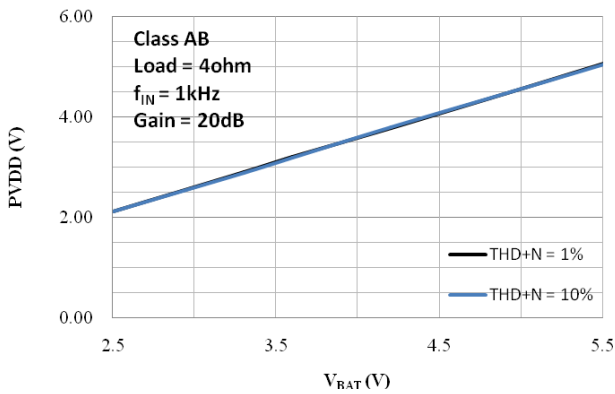

P_O vs THD+N

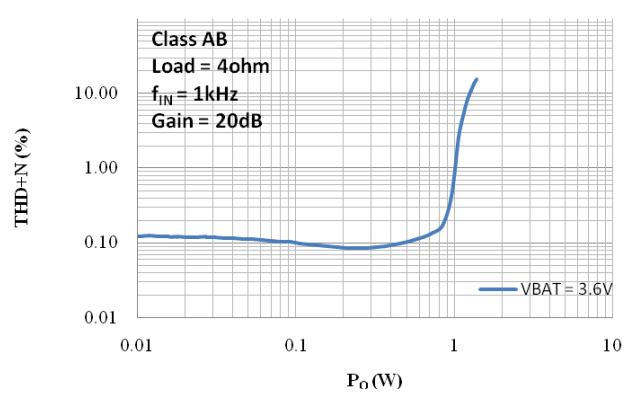

f_{IN} vs Gain

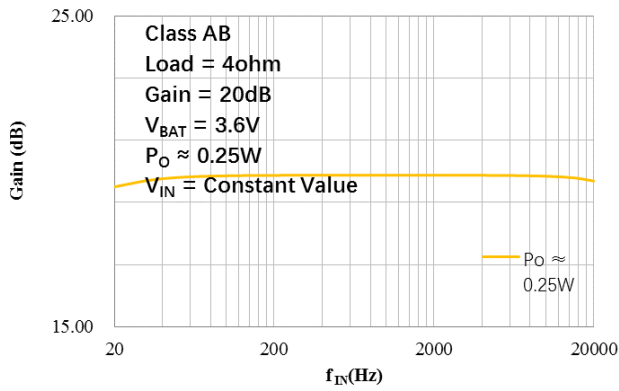

f_{IN} vs THD+N

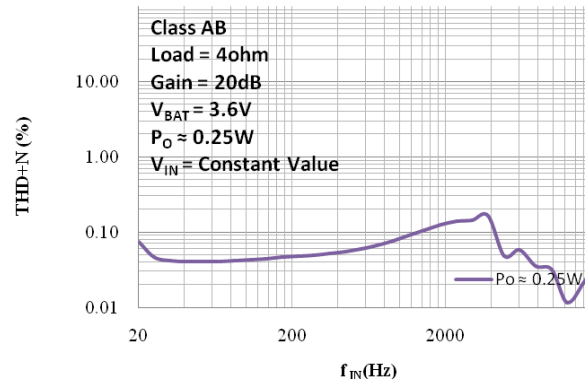

P_O vs η

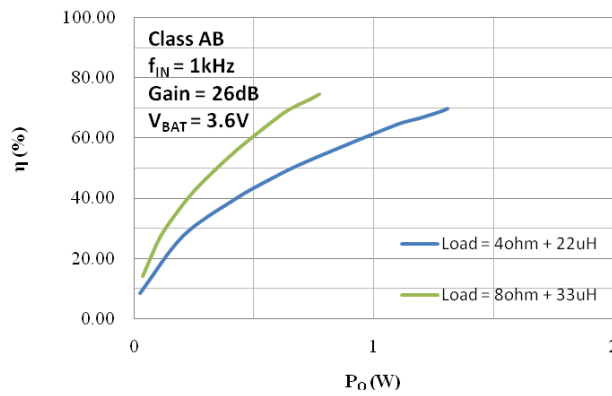

APPLICATION INFORMATION

● BOOST Converter

(1) Setting Output Voltage

The output voltage is set by a resistive voltage divider from the output voltage to FB terminal, which is shown below. The output voltage can be calculated by $PVDD = 1.24 * (Rd1 + Rd2) / Rd2$.

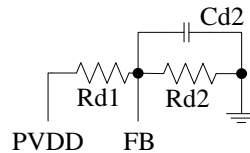

Fig. 1 FB Terminal Configuration

Some typical output voltages can be got by following settings.

Table 1. Output Voltage Setting

PVDD	Rd1	Rd2	Cd2
5.0V	510K	165K	3.3nF
6.5V	510K	120K	3.3nF
7.0V	510K	110K	3.3nF
7.5V	510k	100k	3.3nF

(2) LX Terminal

It is strongly recommended to place an RC circuit from the terminal of LX to Ground, shown as following, so that the ripple current of Boost Converter can be decreased. Meanwhile, the total consumption current of the system will be larger so that the efficiency of the system will be lower. Specifications in this file is measured under the condition with RC.

Notes: RC should be placed as closely to LX pin as possible.

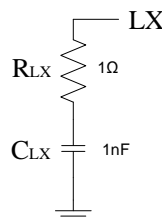

Fig. 2 LX Terminal Configuration

(3) Capacitor Selection

The input and output capacitor (C_{IN} and C_{OUT}) is required to maintain the DC voltage. Low ESR capacitors are preferred to reduce the output voltage ripple. 1uF//10uF//220uF (paralleled) is highly recommended to be placed in both input and output terminal as closely to the pin as possible. If possible, 470uF is better than 220uF.

(4) Inductor Selection

Inductance value is decided based on different condition. $L \geq 4.7\mu H$, $DCR < 1\Omega$, $I_{SAT} \geq 2.5A$ is recommended for general application circuit.

(5) Schottky Diode Selection

$V_{RRM} > 12V$, $V_{FM} < 0.5V$, $I_F \geq 1.5A$ is recommended for general application circuit.

(6) Layout Consideration

1. The power traces, consisting of the GND, LX, V_{BAT} and PVDD trace should be kept short, direct, wide,

and as closely to the pin as possible. The switching node LX should be paid more attention for EMI and reliability consideration.

2. Place C_{IN} and C_{OUT} near V_{BAT} and $PVDD$ as closely as possible to maintain voltage steady, and filter out the pulsing current.
3. The resistive divider R should be connected to pin directly as closely as possible. FB is a sensitive node. Please keep it away from switching node, LX .
4. The GND of the IC, C_{IN} and C_{OUT} should be connected close together directly to ground plane.

● **Analog Signal Input Configuration**

HT8691 is an amplifier with analog input (single-ended or differential). For a differential operation, input signals into $IN+$ and $IN-$ pins via DC-cut capacitors (C_{IN}) and external input resistors R_{IN} . The input signal gain is calculated by $Gain \approx R_F / (External R_{IN} + Internal R_{IN})$. And the high pass cut-off frequency of input signal can be calculated by $f_c = \frac{1}{2\pi(External R_{IN} + Internal R_{IN}) \times C_{IN}}$.

For a single-ended operation, input signals to $IN+$ pin via a DC-cut capacitor (C_{IN}) and external input resistor (R_{IN}). $IN-$ pin should be connected to ground via a DC-cut capacitor and external input resistor (R_{IN}) (with the same value of C_{IN} and R_{IN}). The Gain and high pass Cut-off frequency are the same as the above case.

Table. 2 Internal input resistors and feedback resistors

Working Mode	Internal R_{IN} (ohm)	R_F (ohm)
Class D mode	10	1200K
Class AB mode	10	420K

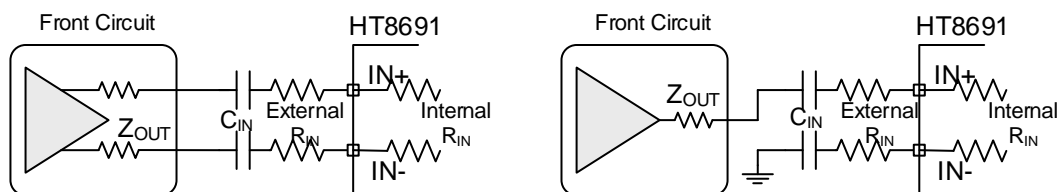

Fig. 3 (1) Differential Input;

(2) Single-ended Input

● **Output Configuration**

As mentioned, HT8691 can directly drive speakers without any other components. But there are exceptions. Once HT8691 works in class D mode, the cable lined to the speaker is very long, and EMI is concerned, ferrite beads or L-C filter is needed.

● **CTRL Terminal Mode Control**

HT8691 can work in different modes by setting the CTRL terminal, shown as follow.

Table. 3 CTRL Terminal Mode Control

MODE	SYMBOL	CTRL Voltage			
		MIN.	TYP.	MAX.	UNIT
Class D mode in ACF-Off with Boost Converter	V_{MOD1}	1.5	1.7	PVDD	V
Class D mode in ACF-ON with Boost Converter	V_{MOD2}	0.91	1.1	1.2	V
Class AB mode in ACF-Off without Boost Converter	V_{MOD3}	0.4	0.6	0.75	V
SD(Shutdown) Mode	V_{MOD4}	0	0	0.28	V

Notes: ACF-ON mode can only be worked in class D mode. A 300kΩ pull-down resistor are inside of the CTRL terminal, shown as follows.



Fig. 4 CTRL Terminal

HT8691 can only be turned into operating mode from shutdown mode when the voltage of CTRL is over 0.8V (1.0V is recommended). Therefore, whenever Class AB is needed from Shutdown mode, Class D should be firstly activated from shutdown mode, before Class AB is activated. The duration of Class D should be short (recommended as 1-10ms) to avoid pop noise. See the timing diagram as follows.

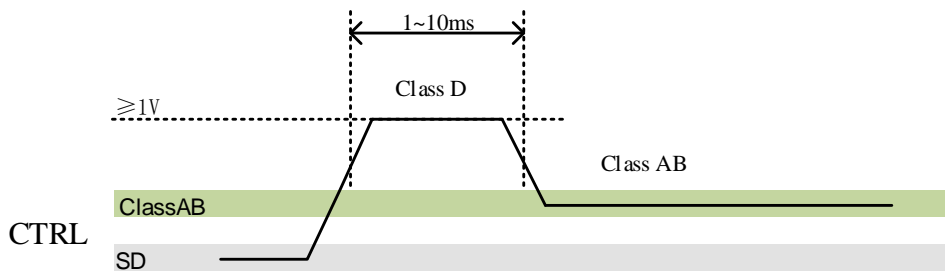

Fig. 5 CTRL Timing for Class AB activated from SD

If shutdown mode is needed to be activated during Class AB, See the timing diagram as follows.

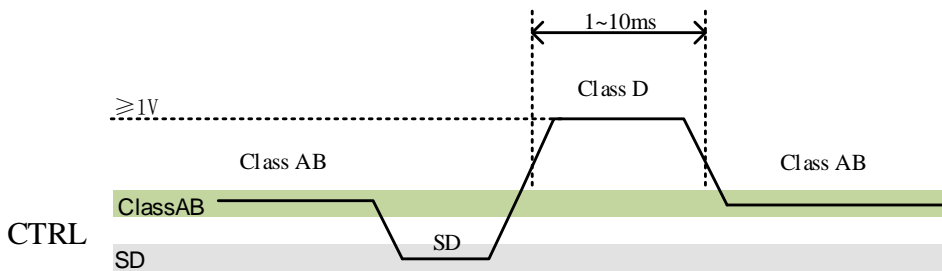

Fig. 6 CTRL Timing for SD in Class AB

MCU Control Setting

By connecting external resistors (R_{CTRL1} , R_{CTRL2} , R_{CTRL3} accuracy of 1%) to CTRL terminal, and setting threshold voltage of each mode to CTRL1 and CTRL2 terminal, different modes can be set. Connect the terminal to the ground through a capacitor C_{CTRL} (a ceramic capacitor of 0.1 μ F or more) to eliminate noise during mode setting.

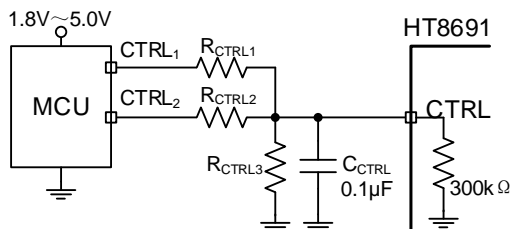

Fig. 7 CTRL terminal control circuit

Table 4 Mode Setting

CTRL1	CTRL2	Mode
H	H	V_{MOD1}
H	L	V_{MOD2}
L	H	V_{MOD3}
L	L	V_{MOD4}

“H” indicates High level output voltage of microcomputer’s I/O port that is input to CTRL1 and CTRL2 terminals and “L” indicates Ground level of the microcomputer. GND level of the microcomputer must be the same as that of HT6881. The control of CTRL terminal is based on I/O port H level output voltage of microcomputer that is connected. Set resistor values according to I/O port H levels, as shown below.

Table 5 H levels vs. Resistor Values

V_H (V)	R_{CTRL1} (kohm)	R_{CTRL2} (kohm)	R_{CTRL3} (kohm)	$V1(HH)$ (V)	$V2(HL)$ (V)	$V3(LH)$ (V)
1.8	18	36	560	1.700	1.130	0.570
2.6	39	75	62	1.740	1.140	0.590
3	30	56	30	1.750	1.140	0.610
3.3	33	62	27	1.770	1.150	0.610
4.2	51	100	24	1.670	1.110	0.560
5	68	130	24	1.660	1.090	0.570

● Anti-Clipping Function (ACF) and mode Configuration

(1) ACF ON Mode

In ACF-ON modes, HT8691 attenuates system gain to an appropriate value when an excessive input is applied, so as not to cause the clipping at the differential signal output. In this way, the output audio signal is controlled in order to obtain a maximum output level without distortion. And HT8691 also follows to the clips of the output waveform due to the decrease in the power-supply voltage.

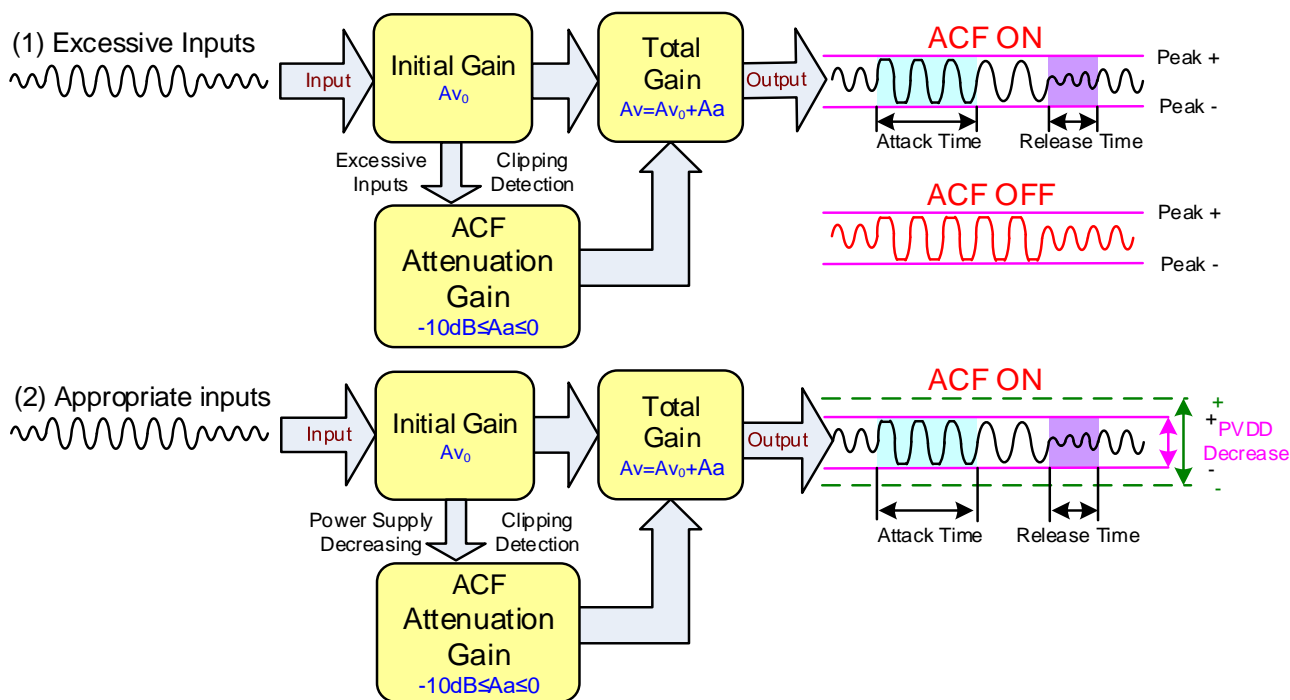

Fig. 8 the ACF Function Operation Outline

The Attack time of ACF Function is a time interval until system gain falls to target attenuation gain -3dB when a big enough signal input. And, the Release Time is a time from target attenuation gain to not working of ACF. The maximum attenuation gain is 16dB.

Table 6 Attack time and Release time

ACF mode	Attack time	Release time
ACF ON	50ms	64ms

(2) ACF OFF Mode

In ACF-Off mode, ACF function is disabled. HT8691 will not detect output clipping and the system gain is kept to be $A_v=A_{v0}$. The audio quality would worsen due to clipping distortion.

(3) Class AB mode

HT8691 works as Class AB audio Amplifier in ACF off mode, the boost converter is disabled.

(4) SD Mode

In shutdown mode, HT8691 shuts all circuit down and minimizes the power consumption. And, the output terminals become Weak Low (A high resistance grounded state).

● Pop-Click Noise Reduction

The Pop-Click Noise Reduction Function of HT8691 works in the cases of Power-on, Power-off, Shutdown on, and Shutdown off. To achieve a more excellent noise reduction performance, it is recommended to use a DC-cut capacitor (C_{IN}) of 0.1 μ F or less.

Besides, POP noise can be minimal according to the following procedure of shutdown control.

- During power-on, Shutdown mode is not cancelled until the power supply is stabilized enough.
- Before Power-off, set Shutdown mode first.

The pop-click noise: Power-on/-off > Shutdown on/off.

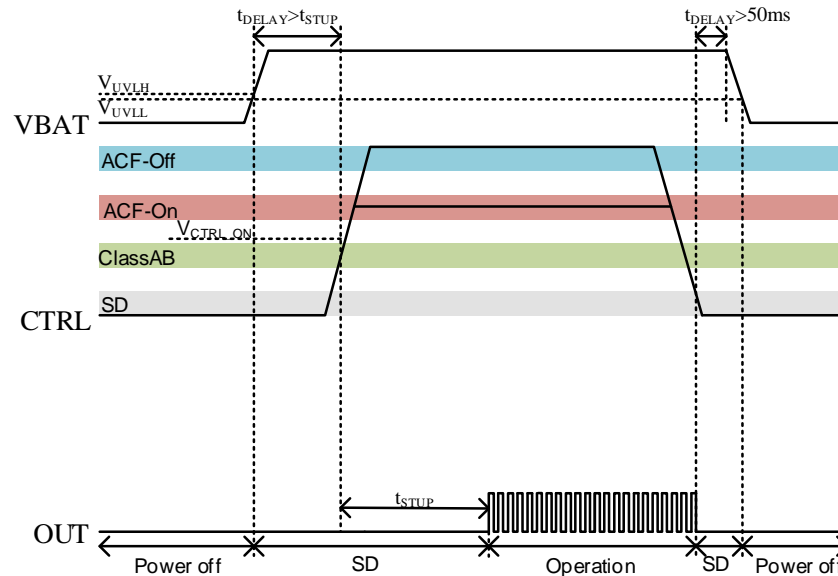

Fig. 9 Pop-Click Noise Reduction by Shutdown

● **Protection Function**

HT8691 has the protection functions such as Over-Current Protection function, Thermal Protection function, and Low Voltage Malfunction Prevention function.

(1) Over-current Protection function

When a short circuit occurs between one output terminal and Ground, PVDD, or the other output, the over-current protection mode starts up. In the over current protection mode, the differential output terminal becomes a high impedance state. Once the short circuit conditions are eliminated, the over current protection mode can be cancelled automatically.

(2) Thermal Protection function

When excessive high temperature of HT8691 (150°C) is detected, the thermal protection mode starts up. In the thermal protection mode, the differential output terminal becomes Weak Low state (a state grounded through high impedance).

(3) Low voltage Malfunction Prevention function

This is the function to establish the low voltage protection mode when PVDD terminal voltage becomes lower than the detection voltage (V_{UVLL}) for the low voltage malfunction prevention. And the protection mode is canceled when PVDD terminal voltage becomes higher than the threshold voltage (V_{UVLH}). In the low voltage protection mode, the differential output pin becomes Weak Low state (a state grounded through high impedance). HT8691 will start up within the start-up time (T_{STUP}) when the low voltage protection mode is cancelled

● PCB Layout

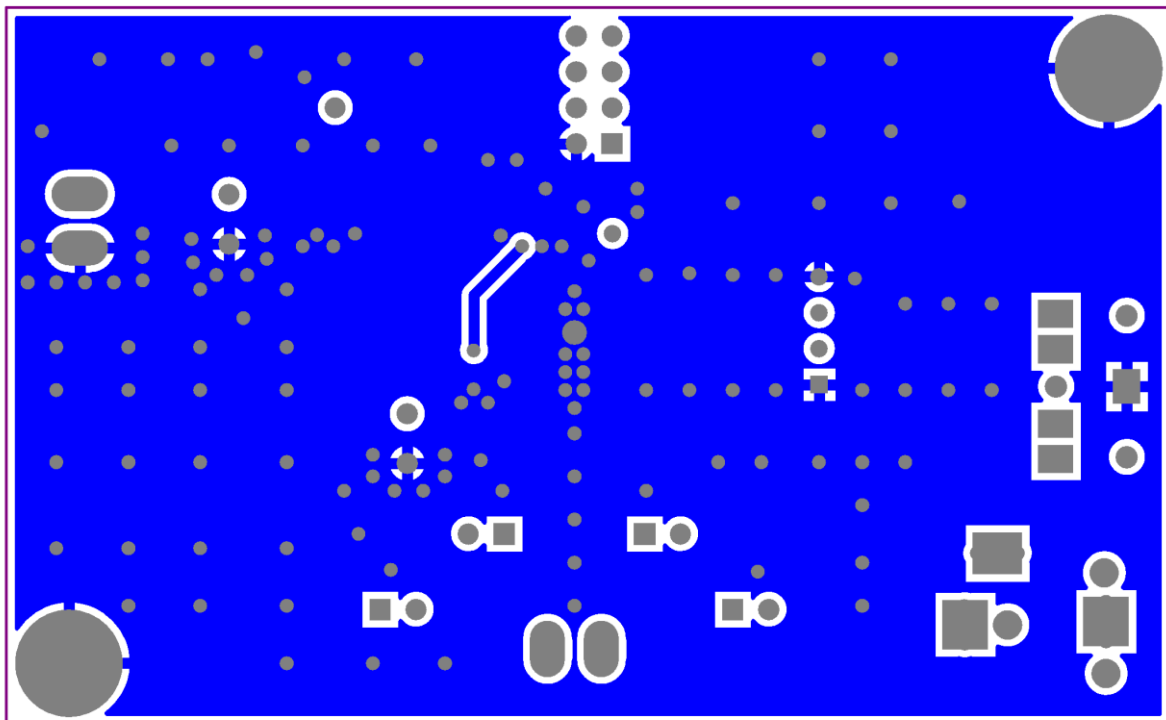
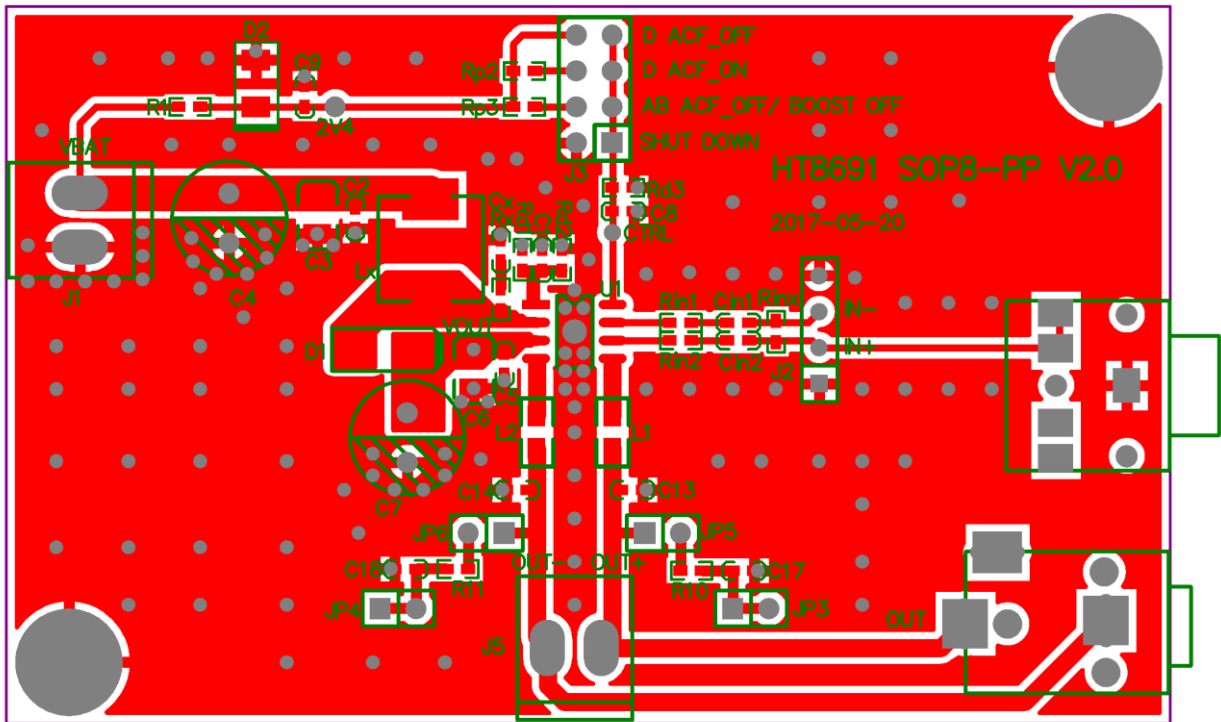

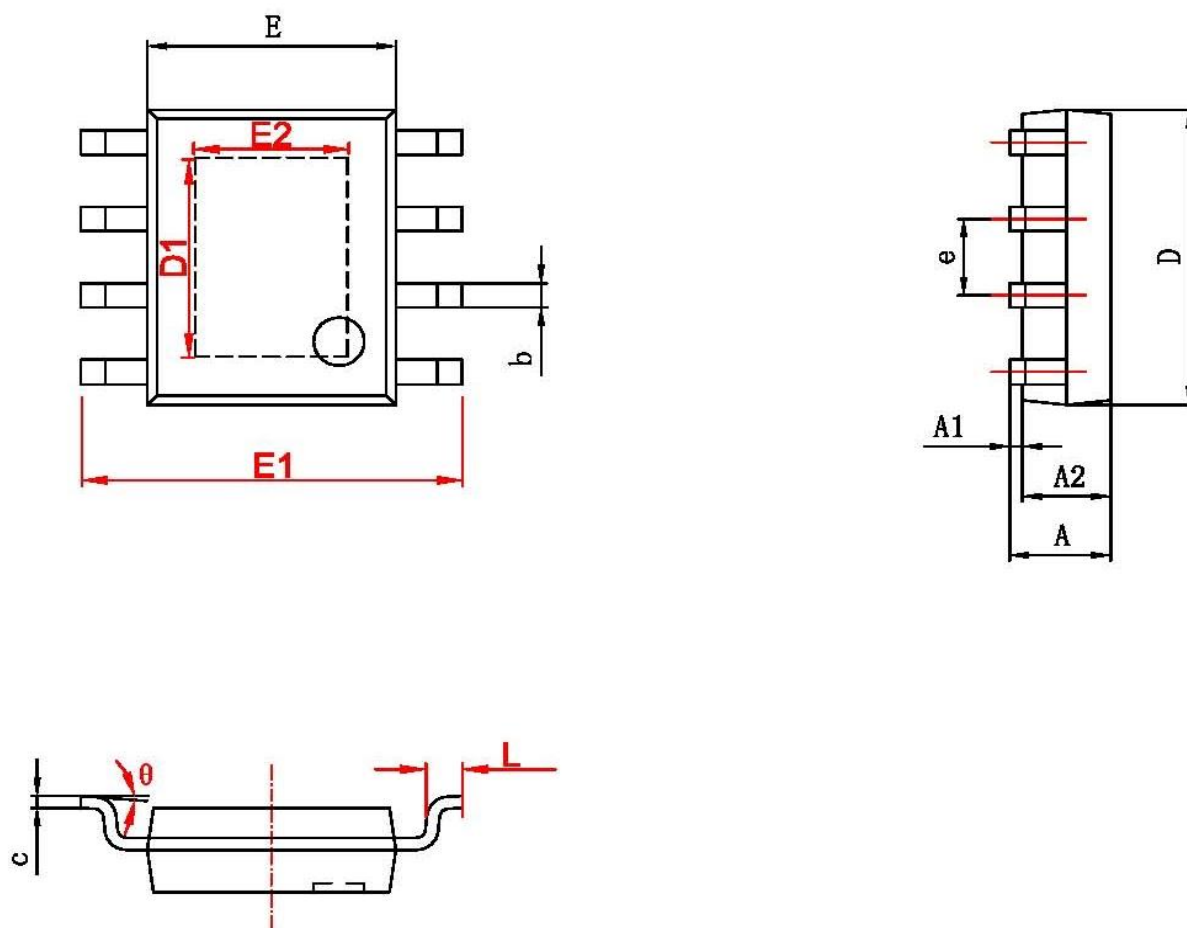
PACKAGE OUTLINE
SOP8-PP(EXP PAD) PACKAGE OUTLINE DIMENSIONS

字符	Dimensions In Millimeters		Dimensions In Inches	
	Min	Max	Min	Max
A	1.350	1.750	0.053	0.069
A1	0.050	0.150	0.002	0.006
A2	1.350	1.550	0.053	0.061
b	0.330	0.510	0.013	0.020
c	0.170	0.250	0.007	0.010
D	4.700	5.100	0.185	0.200
D1	3.202	3.402	0.126	0.134
E	3.800	4.000	0.150	0.157
E1	5.800	6.200	0.228	0.244
E2	2.313	2.513	0.091	0.099
e	1.270 (BSC)		0.050 (BSC)	
L	0.400	1.270	0.016	0.050
θ	0°	8°	0°	8°

IMPORTANT NOTICE

注意

Jiaxing Heroic Electronic Technology Co., Ltd (HT) reserves the right to make corrections, modifications, enhancements, improvements, and other changes to its products and services at any time and to discontinue any products or services. Customers should obtain the latest relevant information before placing orders and should verify that such information is current and complete.

嘉兴禾润电子科技有限公司（以下简称HT）保留对产品、服务、文档的任何修改、更正、提高、改善和其他改变，或停止提供任何产品和服务的权利。客户在下单和生产前应确保所得到的信息是最新、最完整的。

HT assumes no liability for applications assistance or customer product design. Customers are responsible for their products and applications using HT components.

HT对相关应用的说明和协助以及客户产品的板级设计不承担任何责任。

HT products are not authorized for use in safety-critical applications (such as life support devices or systems) where a failure of the HT product would reasonably be expected to affect the safety or effectiveness of that devices or systems.

HT的产品并未授权用于诸如生命维持设备等安全性极高的应用中。

The information included herein is believed to be accurate and reliable. However, HT assumes no responsibility for its use; nor for any infringement of patents or other rights of third parties which may result from its use.

本文中的相关信息是精确和可靠的，但HT并不对其负责，也不对任何可能的专利和第三方权利的侵害负责。

Following are URLs and contacts where you can obtain information or supports on any HT products and application solutions:

下面是可以联系到我公司的相关链接和联系方式：

嘉兴禾润电子科技有限公司

Jiaxing Heroic Electronic Technology Co., Ltd.

地址：浙江省嘉兴市凌公塘路3339号JRC大厦A座三层

Add: A 3rd floor, JRC Building, No. 3339, LingGongTang Road, Jiaxing, Zhejiang Province

Sales: 0573-82585539, sales@heroic.com.cn

Support: 0573-82586151, support@heroic.com.cn

Fax: 0573-82585078

Website: www.heroic.com.cn; wap.heroic.com.cn

Wechat MP: HEROIC_JX

请及时关注禾润官方微信公众号，随时获取最新产品信息和技术资料！

