

REV.	DESCRIPTION	APPD.	DATE

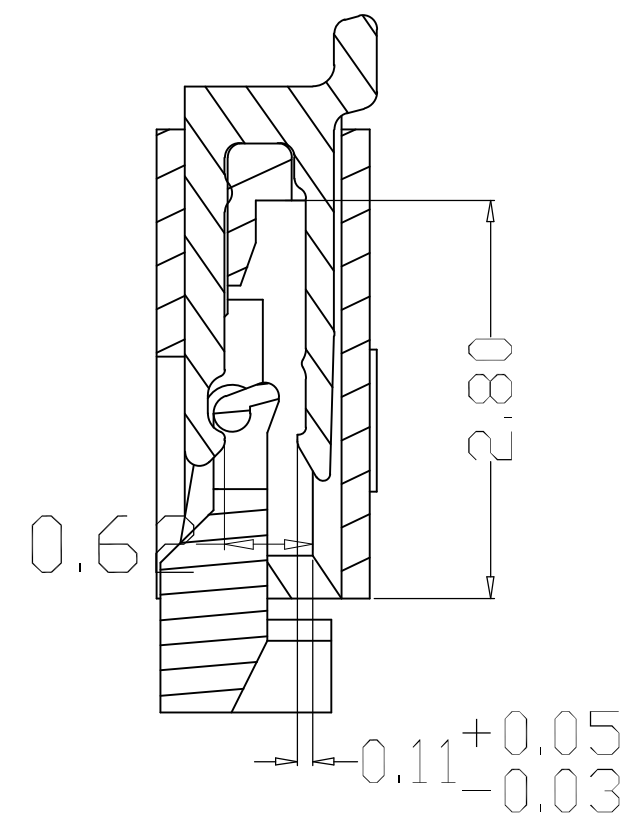

NOTES:

- MATERIAL:  
HOUSING: HIGH TEMPERATURE THERMOPLASTIC  
UL94V\_0, COLOR:BLACK.  
CONTACT: COPPER ALLOYS.
- PLATING:  
UNDERPLATE: NICKEL.  
CONTACT AREA: TIN OVER NICKEL.
- MULTIMEDIA CARD COMPATIBLE

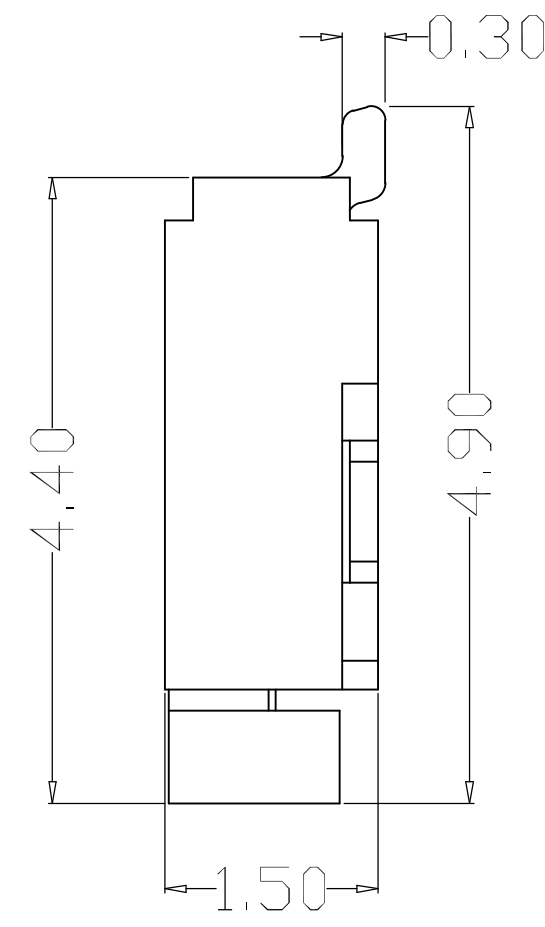
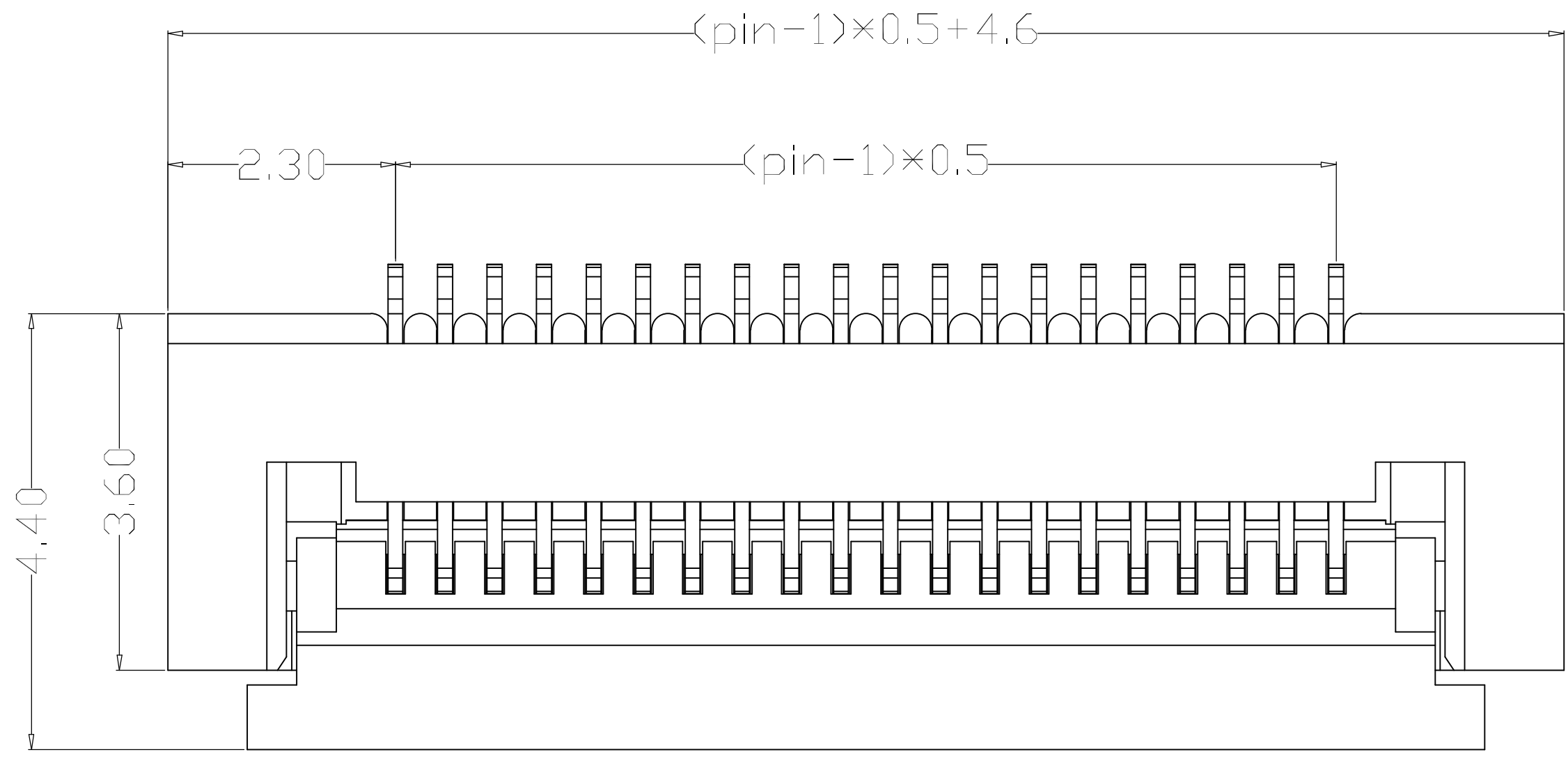
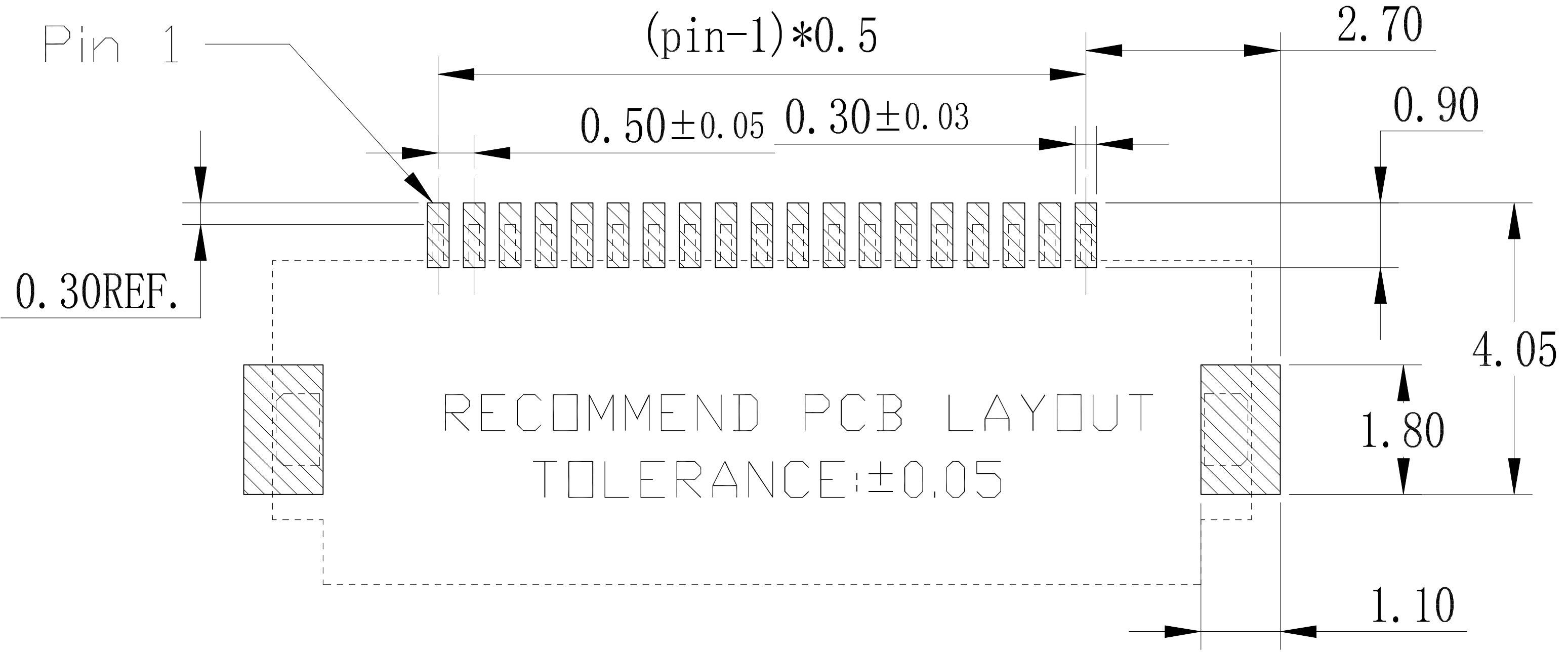
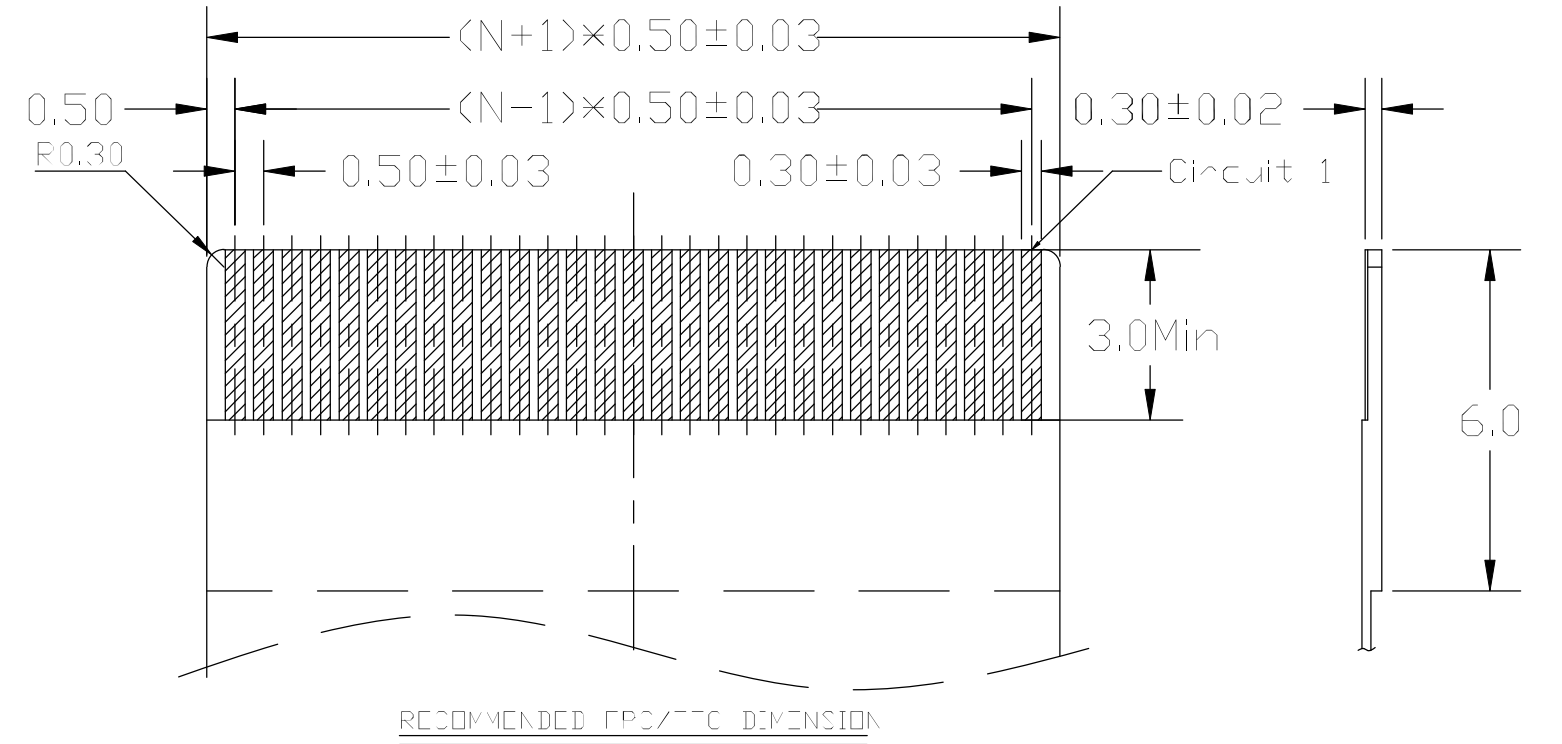
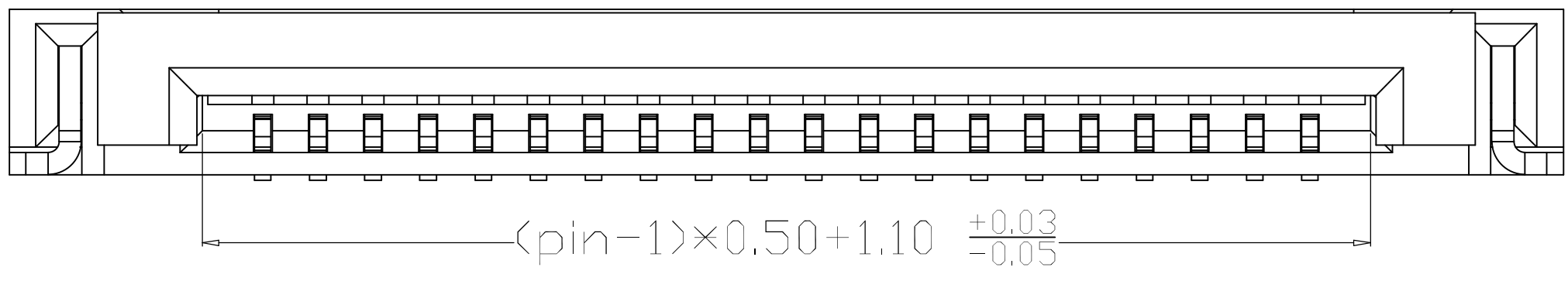

PART NO:		MATERIAL:		
LOT NO:		FINISH:		
UNIT: MM	SIZE: A4	COLOR:		
TOLERANCES: X.X±0.35 X.XX±0.25 X.XXX±0.15		GENERAL ANGLE: X.X=±3.0° X.XX=±2.0°		TITLE: 0.5mm P数:14 翻盖式 下接
DR:		CHK:		DWG NO: ZX-FPC-FWX0.5PH1.514
APP:		SCALE: 1:1		REV: C/0
		SHEET: 1 OF 1		