

Features

- $R_{DS(ON)}, V_{GS}@10V, I_D@16A < 9m\Omega$
- $R_{DS(ON)}, V_{GS}@4.5V, I_D@8A < 13m\Omega$
- High switching speed
- Improved dv/dt capability
- Low Gate Charge
- Low reverse transfer capacitance
- Lead free in compliance with EU RoHS 2.0

Application

- Load/Power Switching
- Interfacing Switching
- Battery Management for Ultra Small Portable Electronics
- Logic Level Shift

Package and Pin Configuration

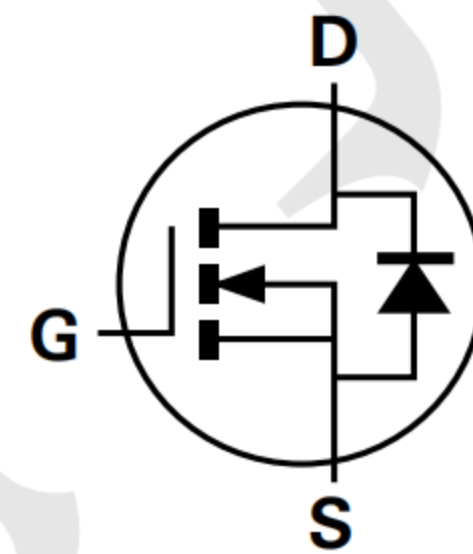
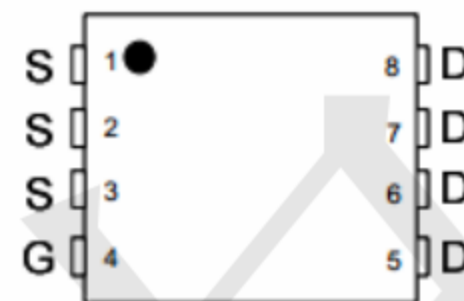
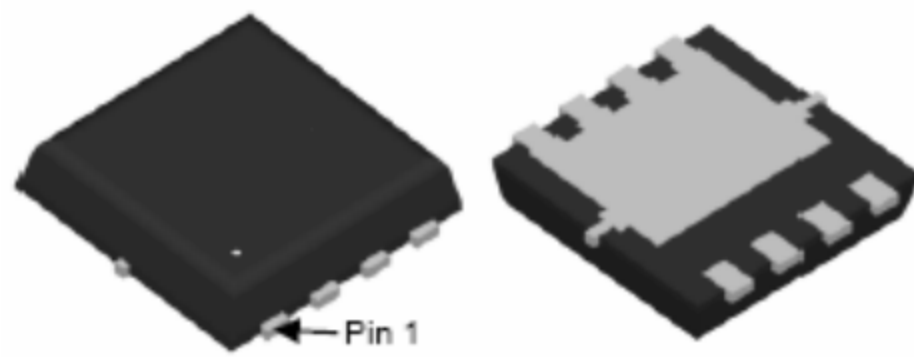

Marking:4408

Absolute Maximum Ratings ($T_A=25^\circ\text{C}$ unless otherwise noted)

PARAMETER	SYMBOL	LIMIT	UNITS
Drain-Source Voltage	V_{DS}	30	V
Gate-Source Voltage	V_{GS}	± 20	V
Continuous Drain Current	I_D	$T_C=25^\circ\text{C}$	42
		$T_C=100^\circ\text{C}$	26
Pulsed Drain Current ^(Note 1)	I_{DM}	168	A
Power Dissipation	P_D	$T_C=25^\circ\text{C}$	35
		$T_C=100^\circ\text{C}$	14
Continuous Drain Current	I_D	$T_A=25^\circ\text{C}$	10
		$T_A=70^\circ\text{C}$	8
Power Dissipation	P_D	$T_A=25^\circ\text{C}$	2.0
Power Dissipation		$T_A=70^\circ\text{C}$	1.3
Operating Junction and Storage Temperature Range		T_J, T_{STG}	-55~150
Typical Thermal Resistance ^(Note 4,5)	Junction to Case	$R_{\theta JC}$	3.6
	Junction to Ambient	$R_{\theta JA}$	62.5

Electrical Characteristics ($T_A=25^{\circ}\text{C}$ unless otherwise noted)

PARAMETER	SYMBOL	TEST CONDITION	MIN.	TYP.	MAX.	UNITS
Static						
Drain-Source Breakdown Voltage	BV_{DSS}	$V_{GS}=0V, I_D=250\mu A$	30	-	-	V
Gate Threshold Voltage	$V_{GS(th)}$	$V_{DS}=V_{GS}, I_D=250\mu A$	1.0	1.7	2.5	V
Drain-Source On-State Resistance	$R_{DS(on)}$	$V_{GS}=10V, I_D=16A$	-	6.5	9	m Ω
		$V_{GS}=4.5V, I_D=8A$	-	9.5	13	
Zero Gate Voltage Drain Current	I_{DSS}	$V_{DS}=30V, V_{GS}=0V$	-	-	1.0	μA
Gate-Source Leakage Current	I_{GSS}	$V_{GS}=\pm 20V, V_{DS}=0V$	-	-	± 100	nA
Dynamic (Note 6)						
Total Gate Charge	Q_g	$V_{DS}=15V, I_D=20A,$ $V_{GS}=4.5V$ (Note 2,3)	-	7.1	-	nC
Gate-Source Charge	Q_{gs}		-	3.1	-	
Gate-Drain Charge	Q_{gd}		-	2.0	-	
Input Capacitance	C_{iss}	$V_{DS}=25V, V_{GS}=0V,$ $f=1.0\text{MHz}$	-	763	-	pF
Output Capacitance	C_{oss}		-	132	-	
Reverse Transfer Capacitance	C_{rss}		-	81	-	
Turn-On Delay Time	$t_{d(on)}$	$V_{DS}=15V, I_D=15A,$ $V_{GS}=10V, R_G=6\Omega$ (Note 2,3)	-	5.4	-	ns
Turn-On Rise Time	t_r		-	86	-	
Turn-Off Delay Time	$t_{d(off)}$		-	20	-	
Turn-Off Fall Time	t_f		-	10	-	
Drain-Source Diode						
Maximum Continuous Drain-Source Diode Forward Current	I_S	---	-	-	42	A
Diode Forward Voltage	V_{SD}	$I_S=1A, V_{GS}=0V$	-	0.7	1.0	V

Typical Characteristics

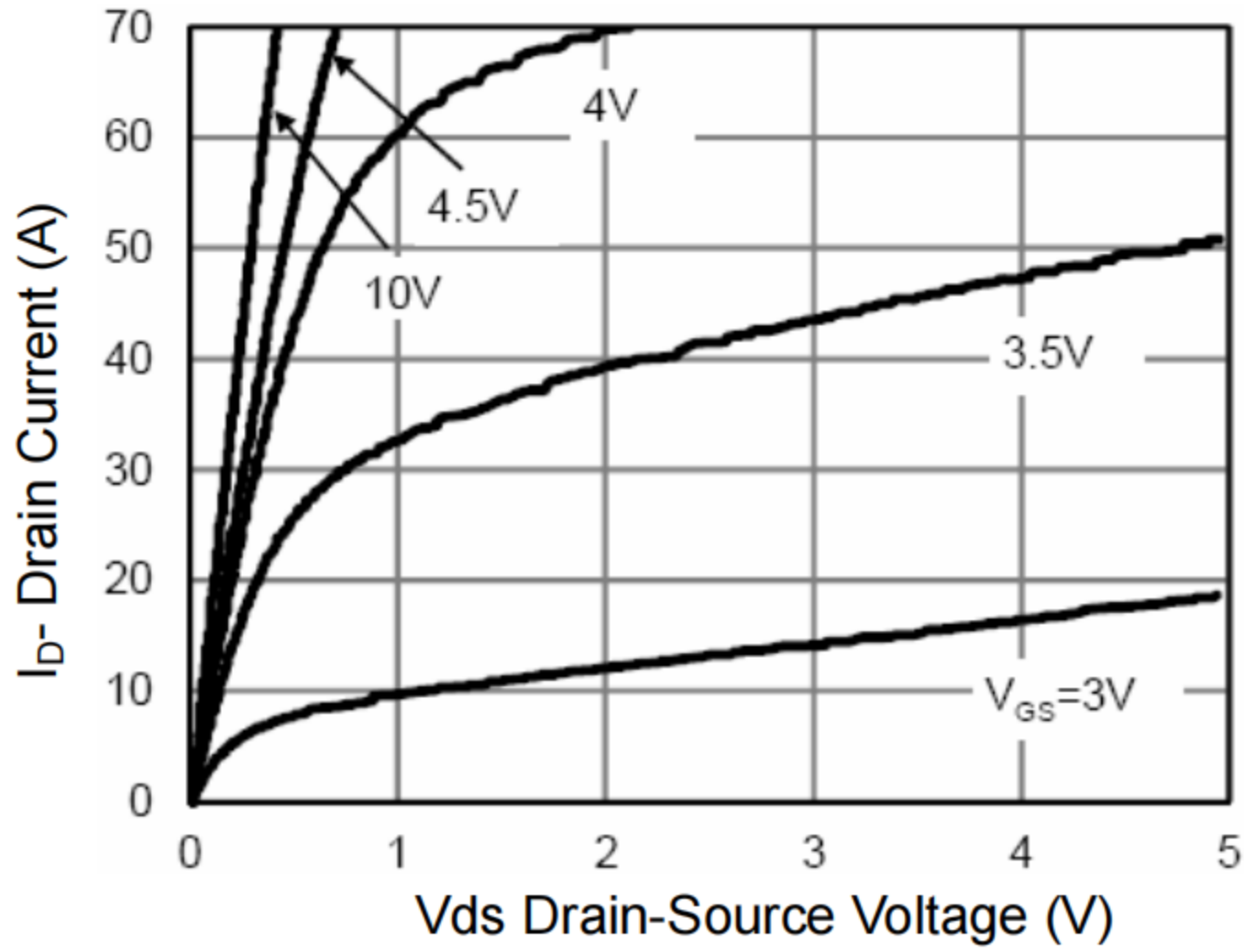

Figure 1 Output Characteristics

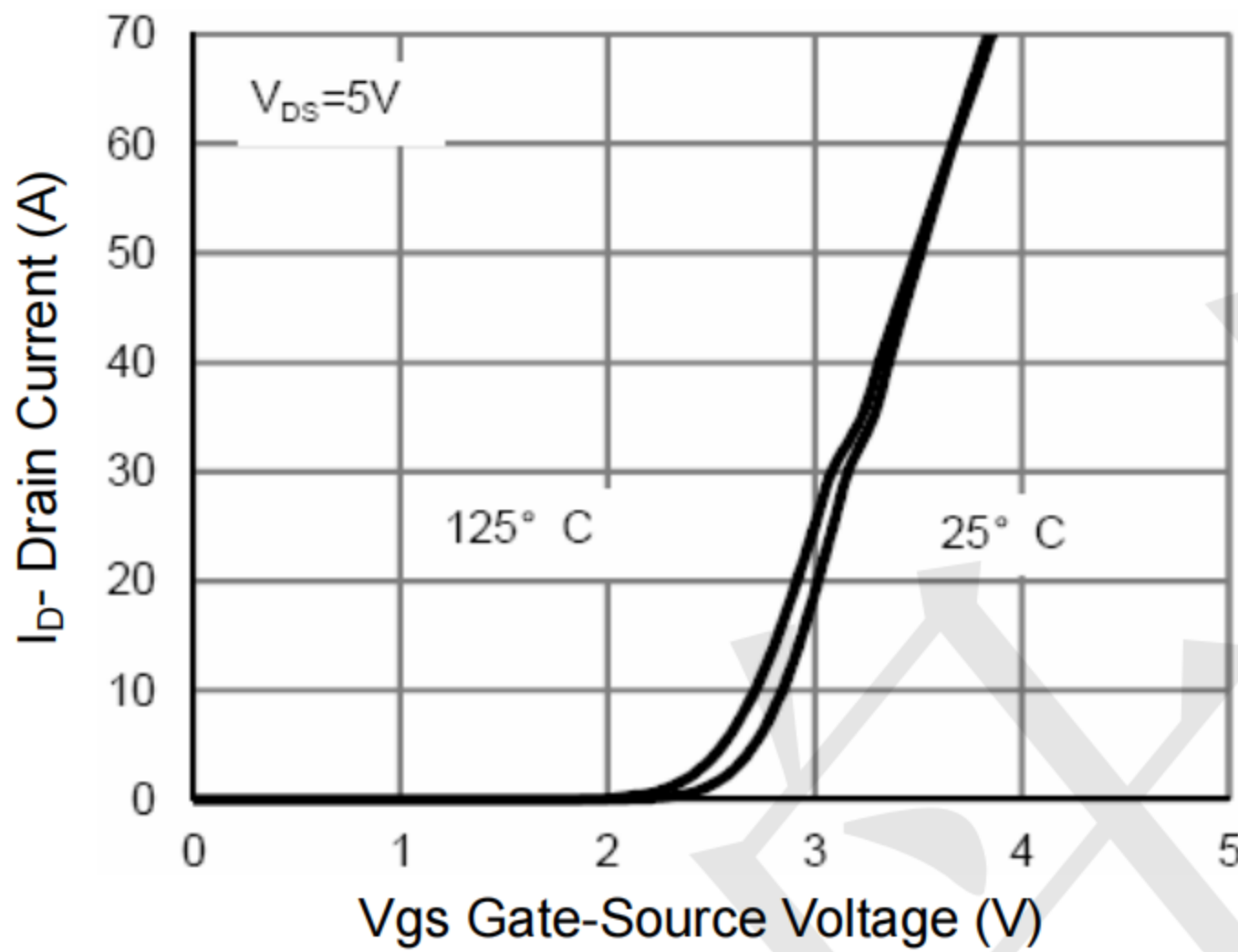

Figure 2 Transfer Characteristics

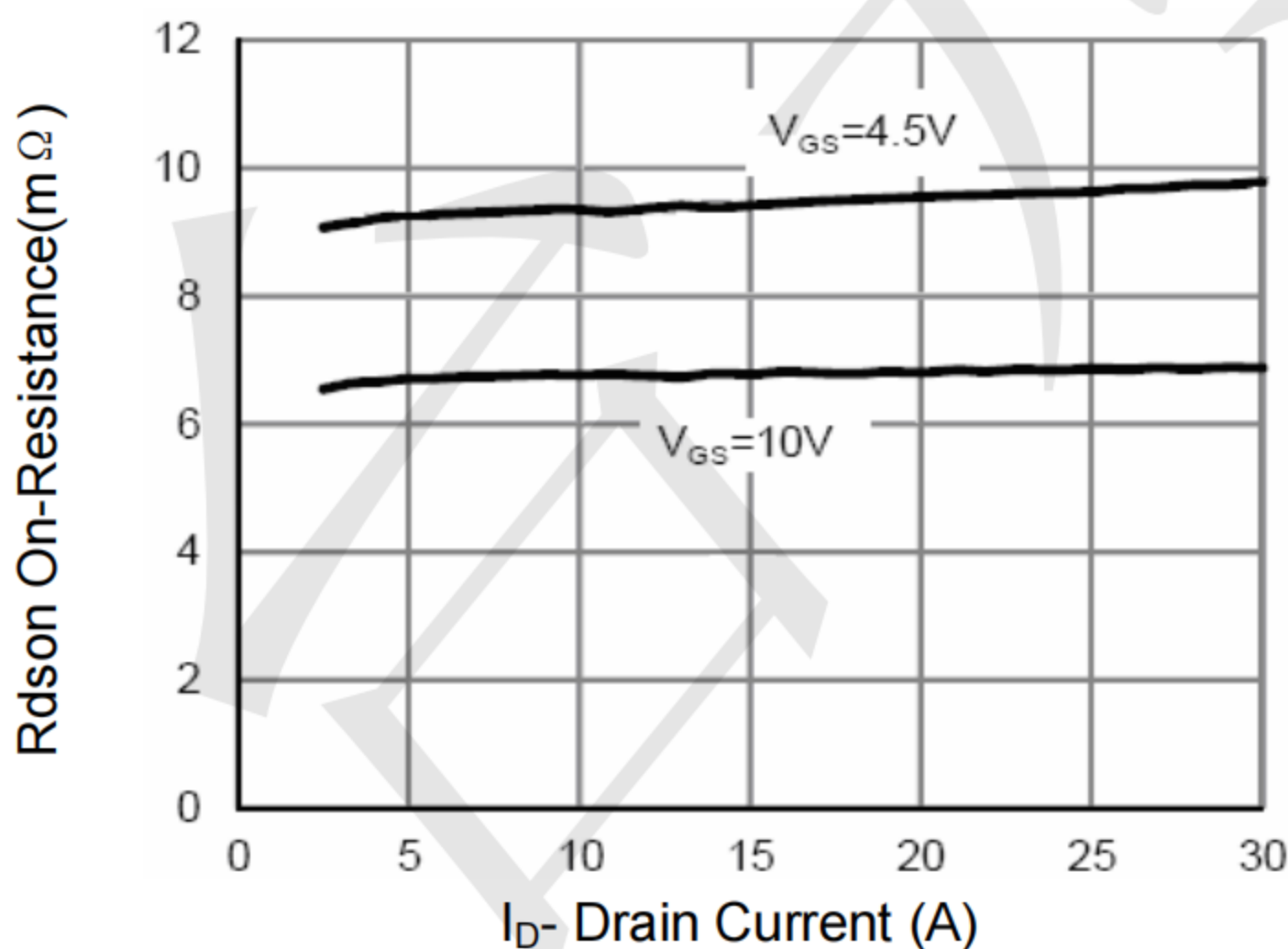

Figure 3 Rds(on)- Drain Current

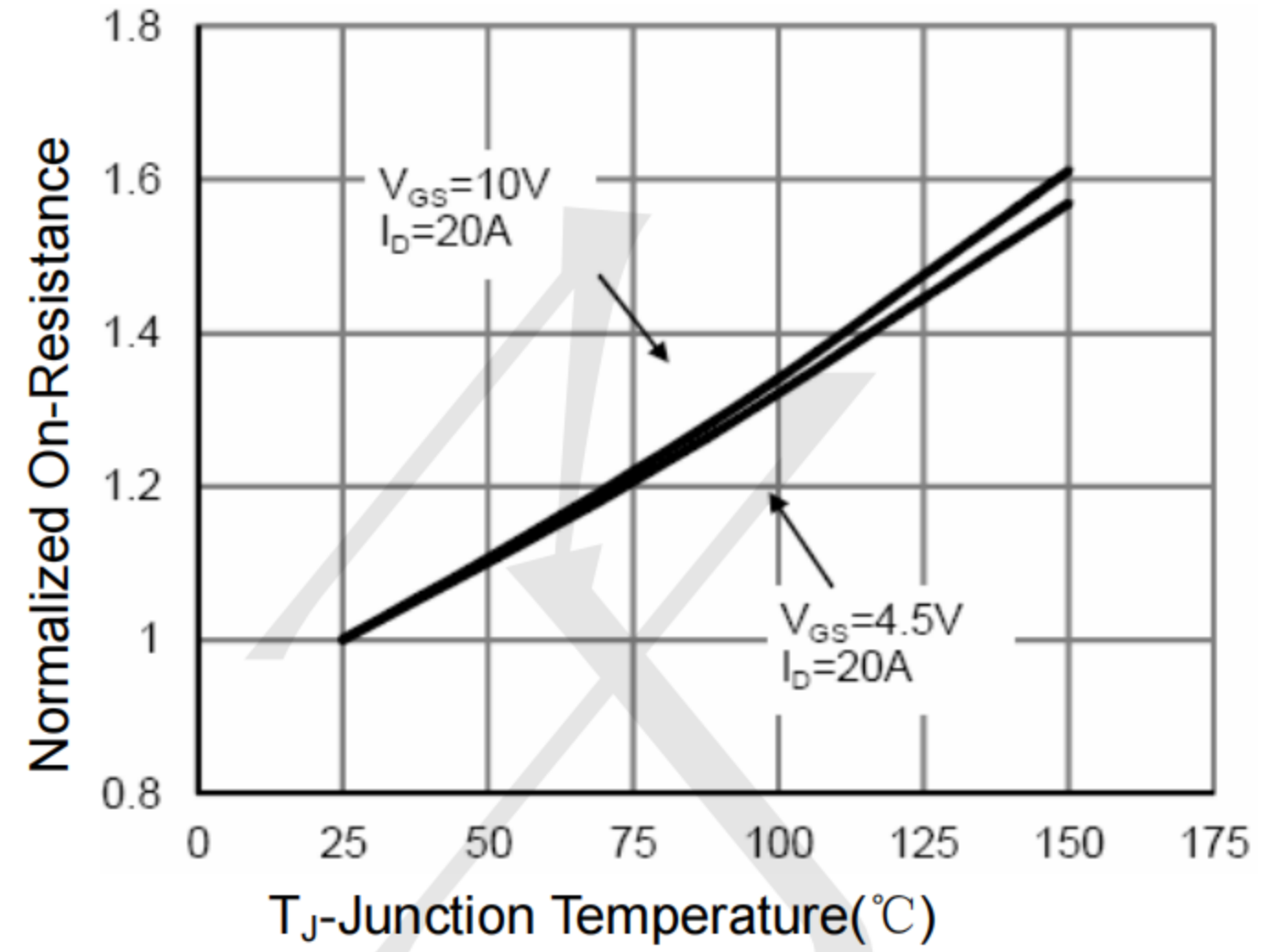

Figure 4 Rds(on)-Junction Temperature

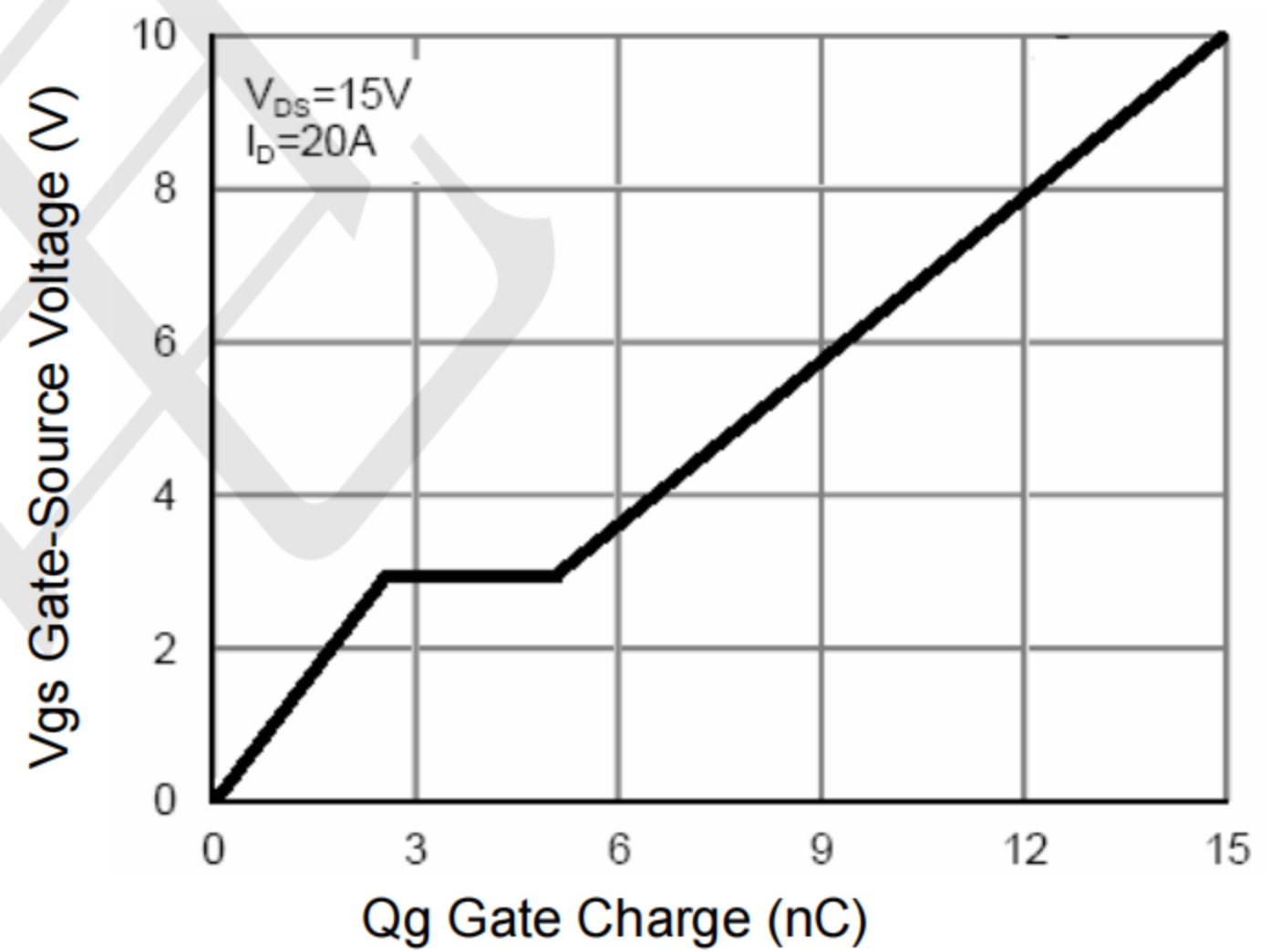

Figure 5 Gate Charge

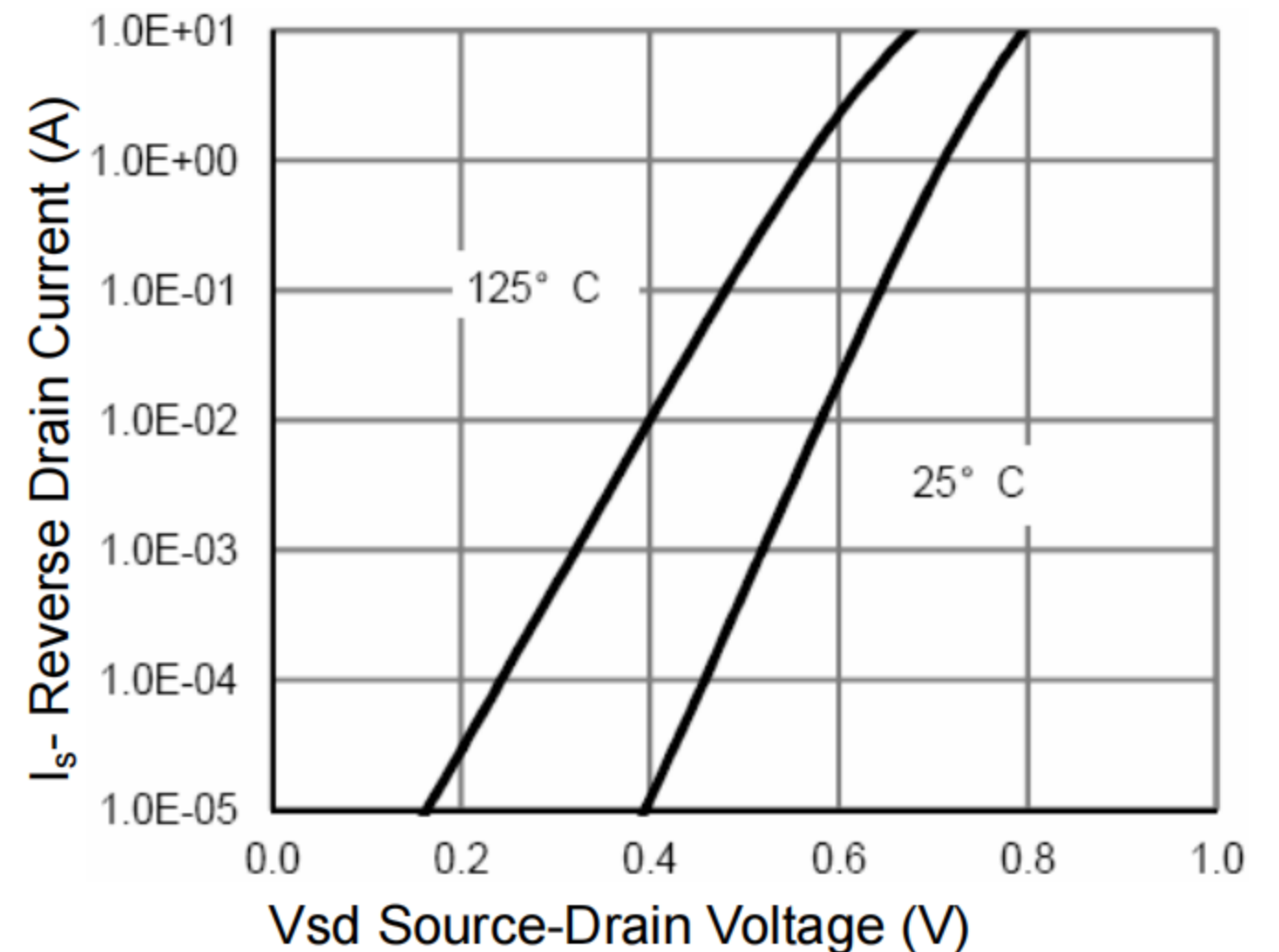

Figure 6 Source- Drain Diode Forward

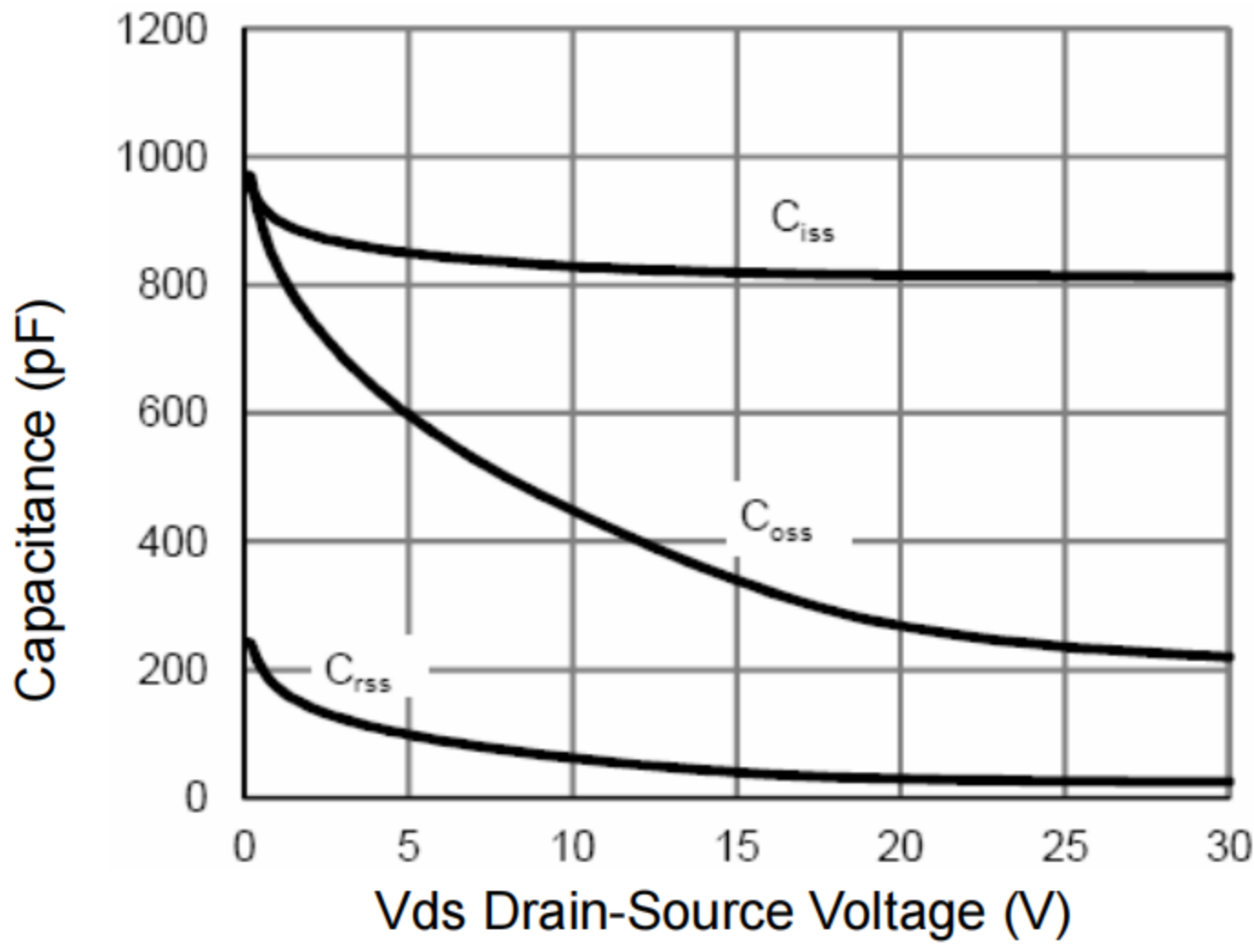

Figure 7 Capacitance vs Vds

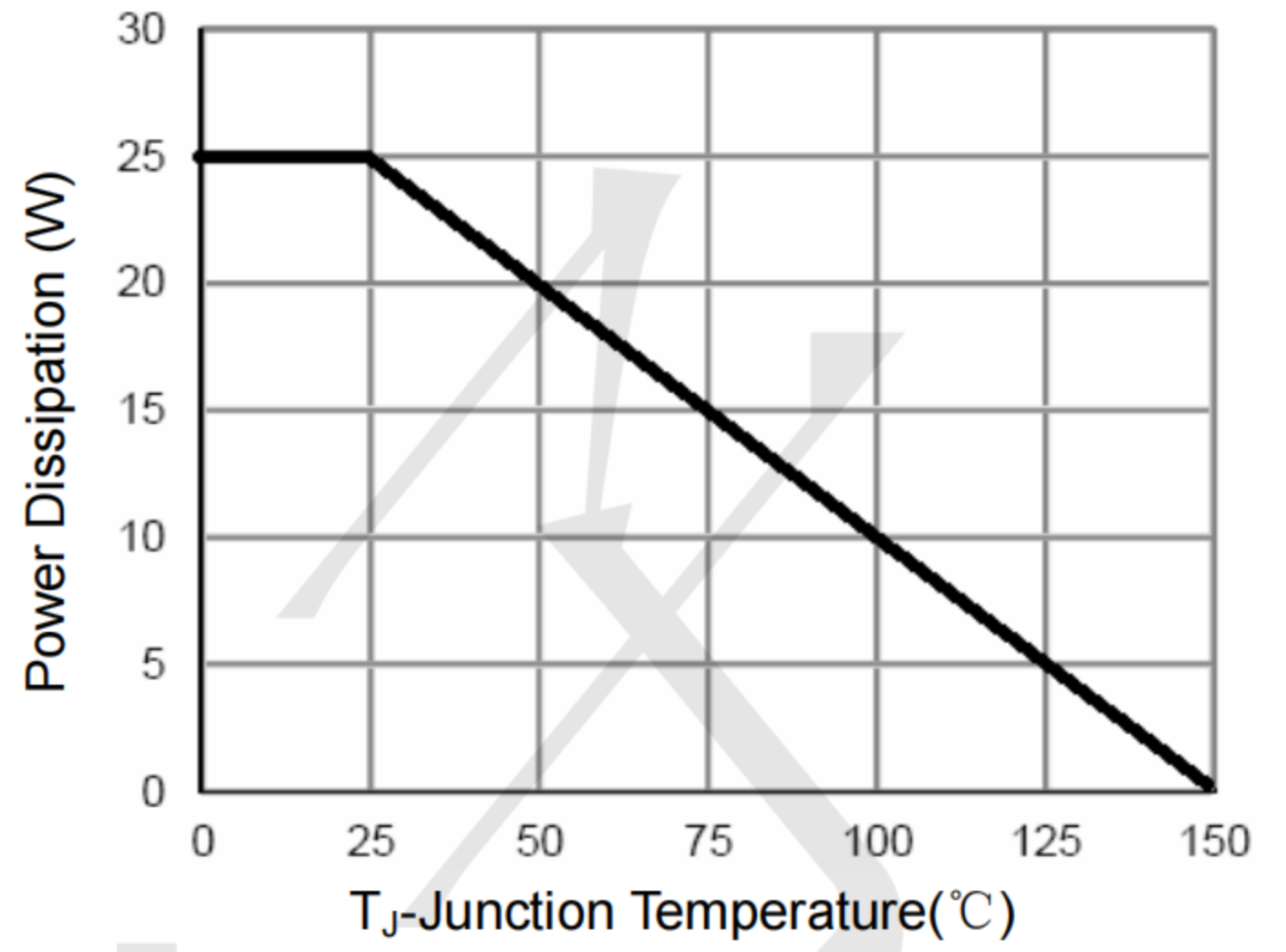

Figure 9 Power De-rating

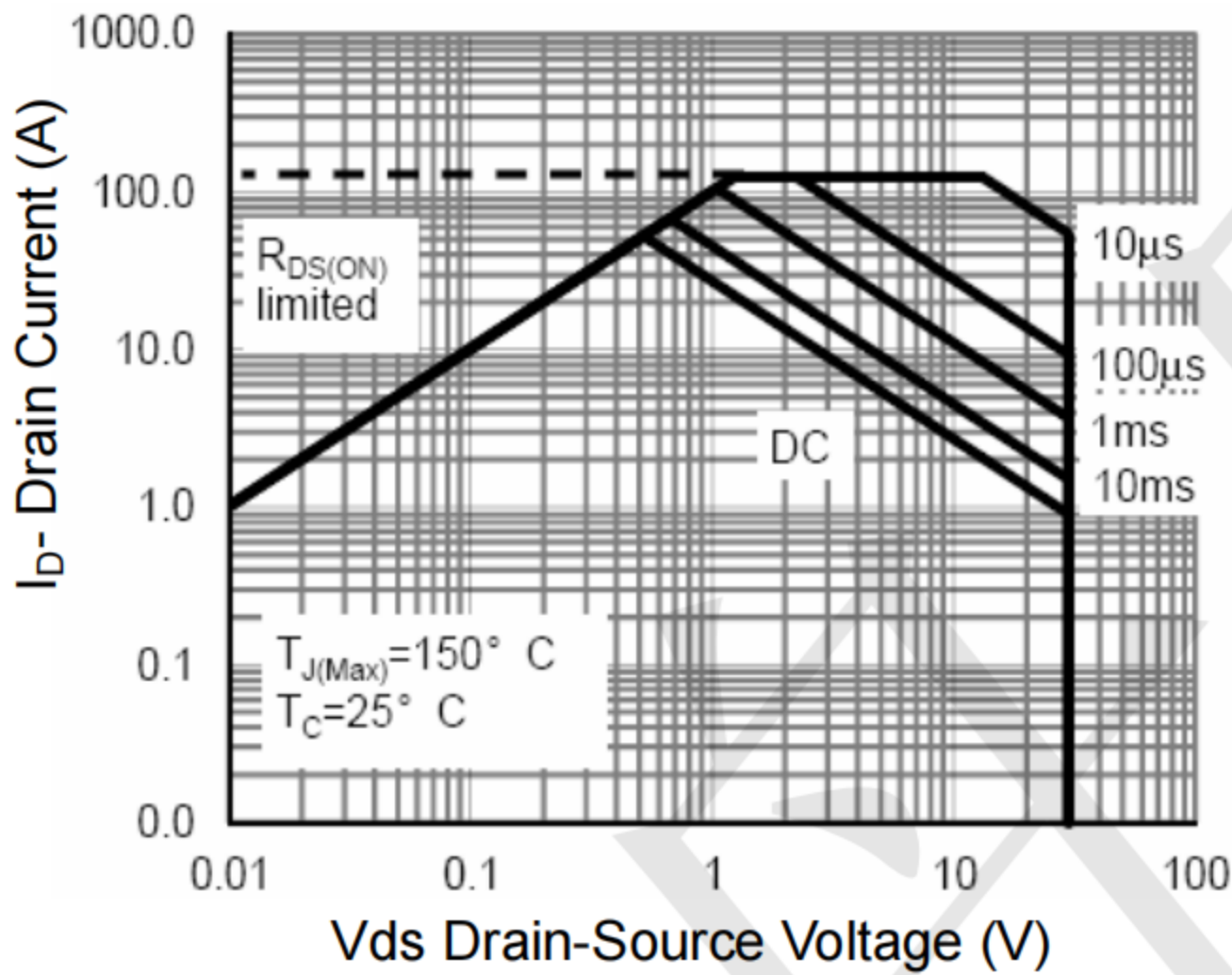

Figure 8 Safe Operation Area

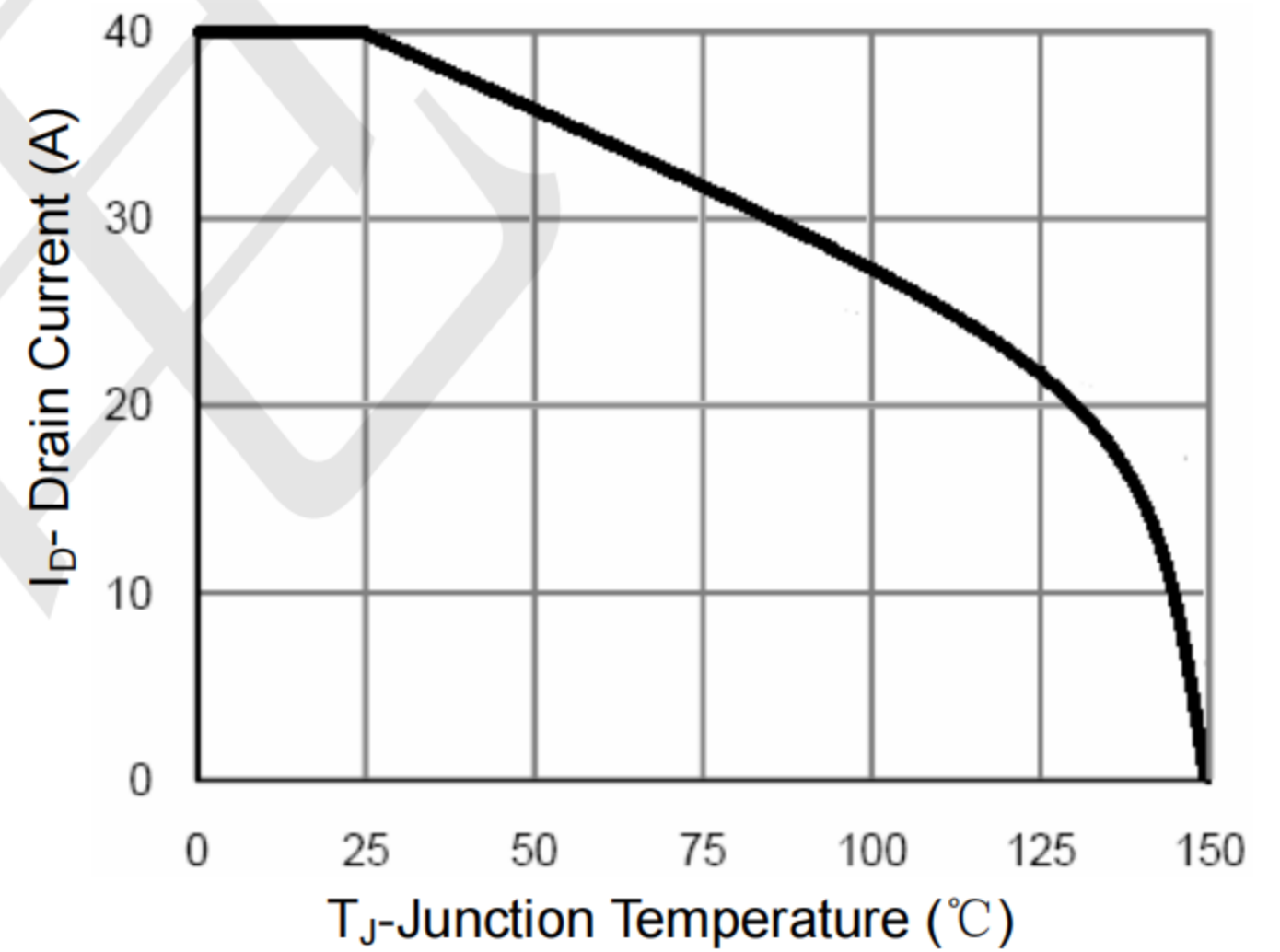

Figure 10 Current De-rating

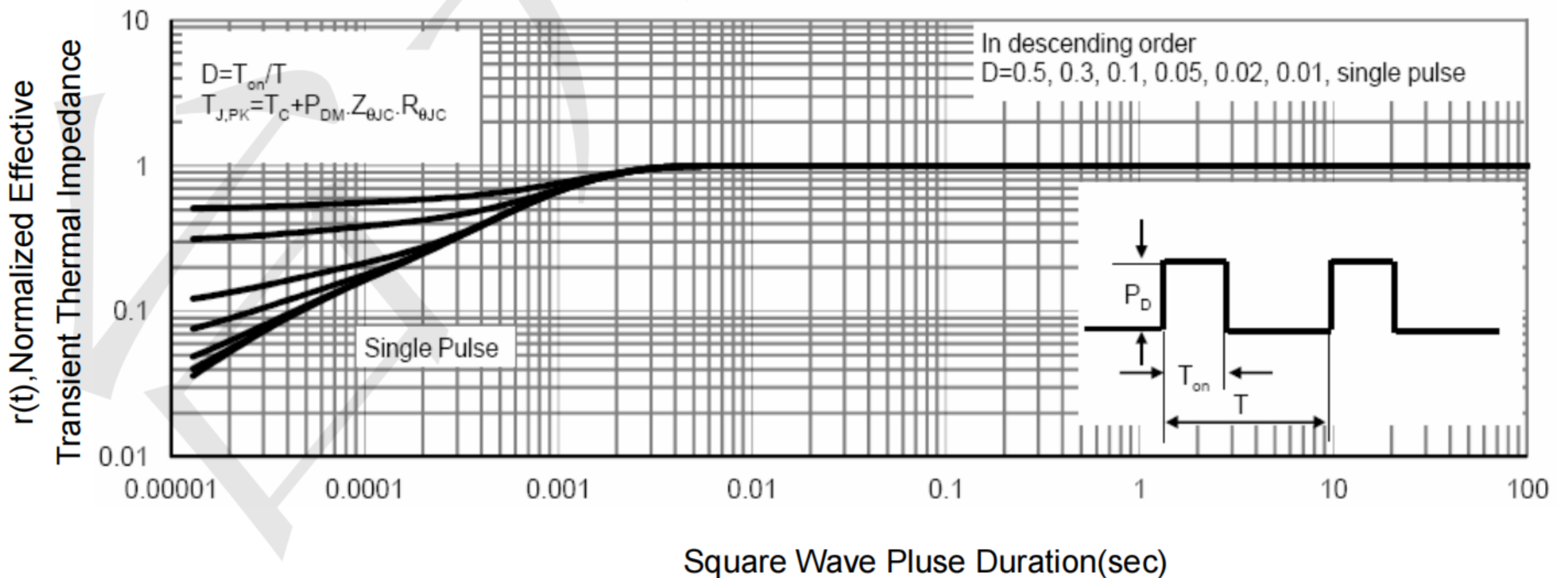
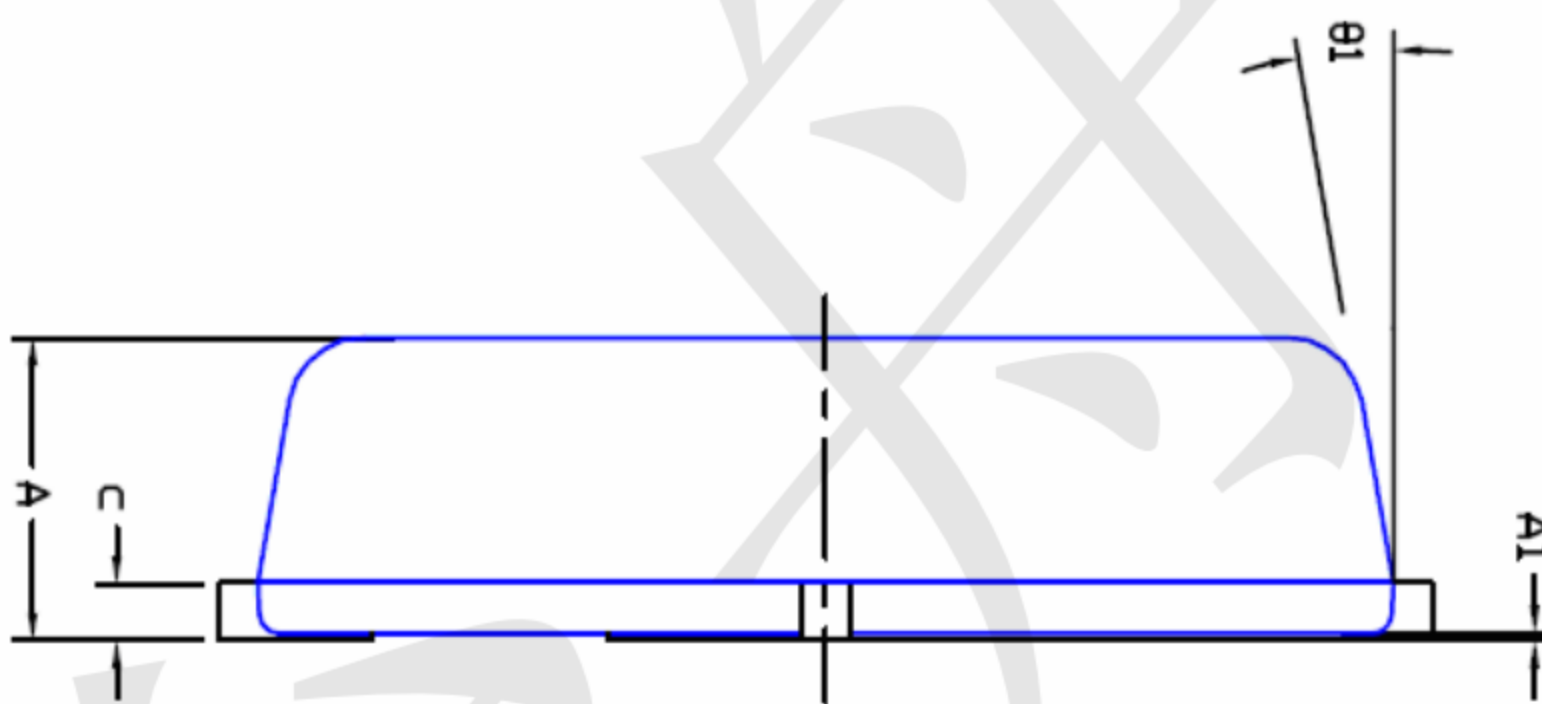
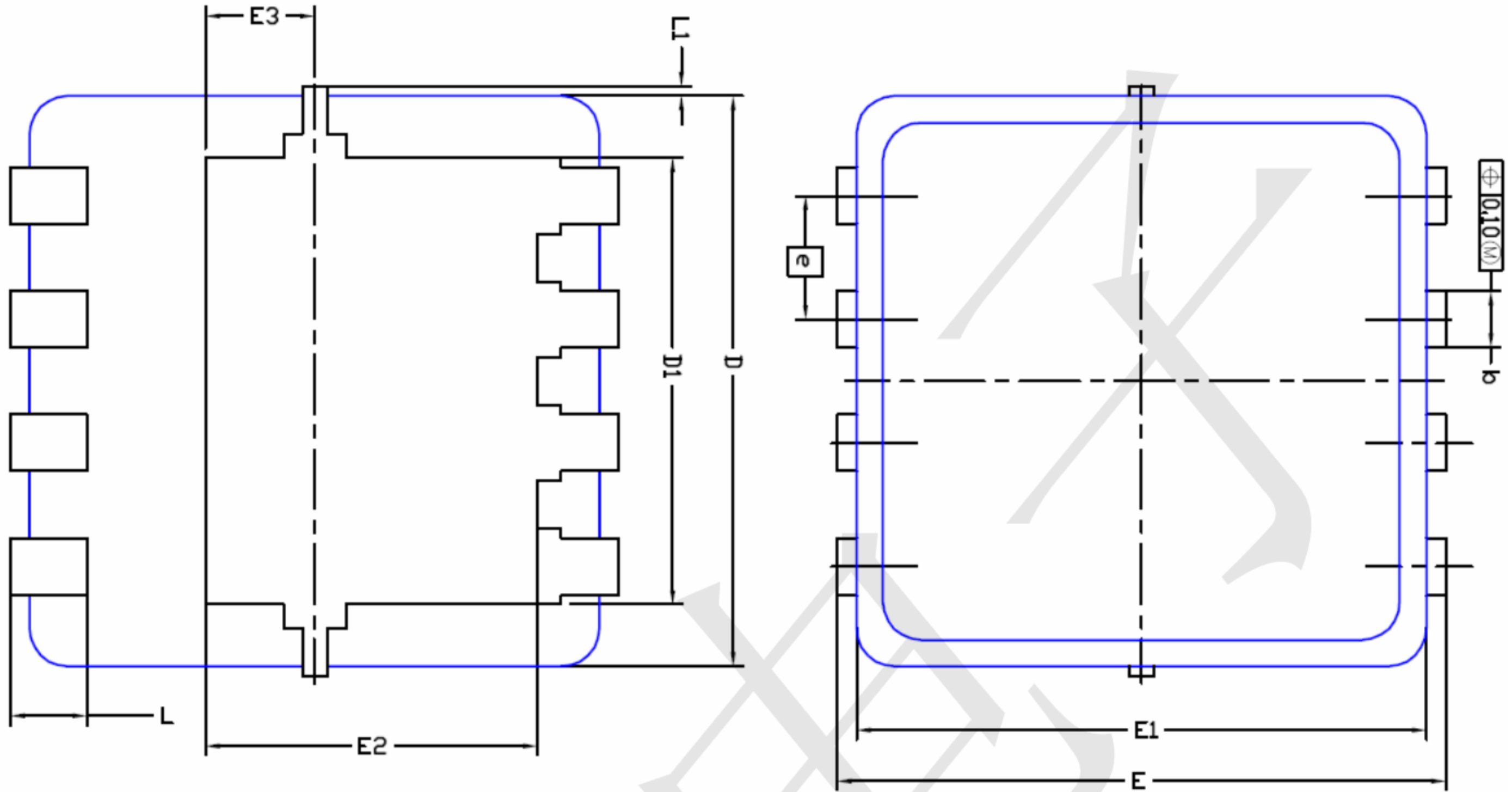

Figure 11 Normalized Maximum Transient Thermal Impedance

DFN3X3 Package Information



DIM.	MILLIMETERS			INCHES		
	MIN	NOM	MAX	MIN	NOM	MAX
A	0.700	0.80	0.900	0.0276	0.0315	0.0354
A1	0.00	---	0.05	0.000	---	0.002
b	0.24	0.30	0.35	0.009	0.012	0.014
c	0.10	0.152	0.25	0.004	0.006	0.010
D	3.00 BSC			0.118 BSC		
D1	2.35 BSC			0.093 BSC		
E	3.20 BSC			0.126 BSC		
E1	3.00 BSC			0.118 BSC		
E2	1.75 BSC			0.069 BSC		
E3	0.575 BSC			0.023 BSC		
e	0.65 BSC			0.026 BSC		
L	0.30	0.40	0.50	0.0118	0.0157	0.0197
L1	0	---	0.100	0	---	0.004
theta	0°	10°	12°	0°	10°	12°