

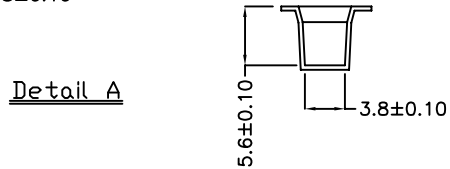

产品

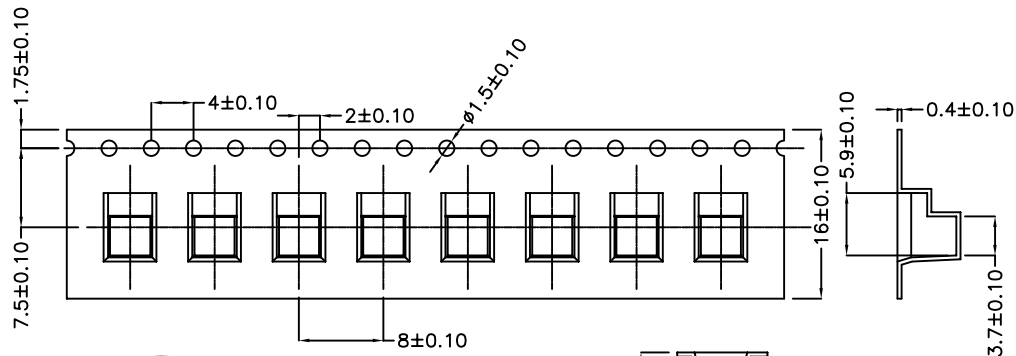
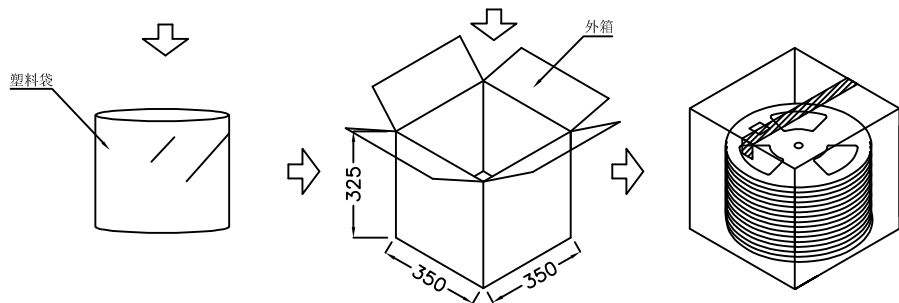
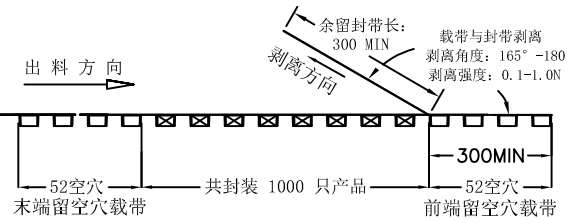
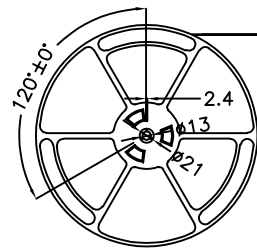
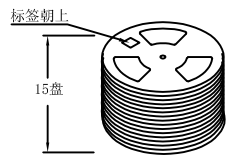
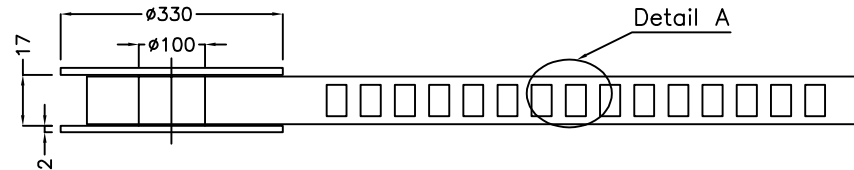
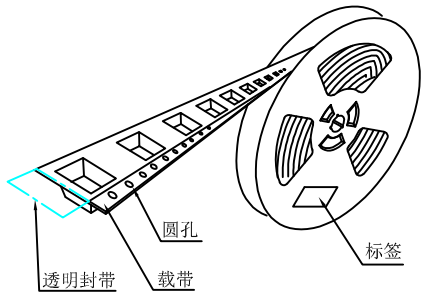

技术要求:

1. 圆孔十个孔距离累计允许公差为 $\pm 0.2\text{mm}$
2. 带长250mm内容许弯曲度1mm
3. 材料厚度以在载带边缘测量为准
4. 所有尺寸定义依循EIA-481-C系准则定义之
5. 材料:透明C料 T=0.40 $\pm 0.10\text{mm}$
6. 所有卷轮为灰蓝挖空旋转塑胶卷轮
7. 整模成型长度:8.832M,
8. 非指明公差范围为: $\pm 0.2\text{mm}$; 超过250mm不计算累计误差
9. 型腔外形凡未标明处倒角R为0.2-0.3; 拔模斜度未标注的为 3° 以下

包装信息:

- 1、每卷盘装产品 1000 只, 卷盘外侧贴相关标签;
- 2、每 15 卷盘放在一个塑料袋中;
- 3、每外箱装15盘, 产品总数: 15000 只;
- 4、外箱上下用胶纸封成“工”字;

UNLESS OTHERWISE SPECIFIED TOLERANCES		MYOUNG 美阳 www.meiyangdz.com			
DECIMALS: X : ±*** X.X : ±*** X.XX : ±*** X.XXX : ±***	ANGLES: X : ±*** X.X : ±***	DSND	YangFeng	DATE	2022-11-01
		CHKD	ZhouRuicai	DATE	2022-11-01
		APVD	XueShun Yong	DATE	2022-11-01
WEIGHT:		SCALE:	1:1	SIZE:	A4
SHEET 1 OF 1		UNIT:	mm	REV.:	A/0
		VIEW:			
		OBJECT:	MY		
		TITLE:		电池接触片-121正极 SMT 卷装	
		PART NO.:		MY-ZJ-121-R	
		DRAW NO.:		MY-BD-0062	