

● General Description

The AGM085N10F combines advanced trench MOSFET technology with a low resistance package to provide extremely low $R_{DS(ON)}$.

This device is ideal for load switch and battery protection applications.

● Features

- Advance high cell density Trench technology
- Low $R_{DS(ON)}$ to minimize conductive loss
- Low Gate Charge for fast switching
- Low Thermal resistance

● Application

- MB/VGA Vcore
- SMPS 2nd Synchronous Rectifier
- POL application
- BLDC Motor driver

Product Summary

BVDSS	RDSON	ID
100V	9mΩ	80A

TO-220F Pin Configuration



Package Marking and Ordering Information

Device Marking	Device	Device Package	Reel Size	Tape width	Quantity
AGM085N10F	AGM085N10F	TO-220F	----	----	1000

Table 1. Absolute Maximum Ratings (TC=25°C)

Symbol	Parameter	Value	Unit
VDS	Drain-Source Voltage (VGS=0V)	100	V
VGS	Gate-Source Voltage (VDS=0V)	±20	V
ID	Drain Current-Continuous(Tc=25°C) (Note 1)	80	A
	Drain Current-Continuous(Tc=100°C)	52.5	A
IDM (pluse)	Drain Current-Continuous@ Current-Pulsed (Note 2)	320	A
PD	Maximum Power Dissipation(Tc=25°C)	78	w
	Maximum Power Dissipation(Tc=100°C)	31	w
EAS	Avalanche energy (Note 3)	81	mJ
TJ,TSTG	Operating Junction and Storage Temperature Range	-55 To 150	°C

Table 2. Thermal Characteristic

Symbol	Parameter	Typ	Max	Unit
RθJA	Thermal Resistance Junction-ambient (Steady State) ¹	---	50	°C/W
RθJC	Thermal Resistance Junction-Case ¹	---	1.6	°C/W

Table 3. Electrical Characteristics (T_J=25°C unless otherwise noted)

Symbol	Parameter	Conditions	Min	Typ	Max	Unit
On/Off States						
BVDSS	Drain-Source Breakdown Voltage	VGS=0V ID=250μA	100	--	--	V
IDSS	Zero Gate Voltage Drain Current	VDS=100V,VGS=0V	--	--	1	μA
IGSS	Gate-Body Leakage Current	VGS=±20V,VDS=0V	--	--	±100	nA
VGS(th)	Gate Threshold Voltage	VDS=VGS,ID=250μA	1.2	2.0	2.1	V
gFS	Forward Transconductance	VDS=5V,ID=15A	--	25	--	S
RDS(on)	Drain-Source On-State Resistance	VGS=10V, ID=20A	--	9.0	10.5	mΩ
		VGS=4.5V, ID=15A	--	12.7	15	mΩ
Dynamic Characteristics						
Ciss	Input Capacitance	VDS=50V,VGS=0V, F=1MHZ	--	1978	--	pF
Coss	Output Capacitance		--	565	--	pF
Crss	Reverse Transfer Capacitance		--	26	--	pF
Rg	Gate resistance	VGS=0V, VDS=0V,f=1.0MHz	--	1.65	--	Ω
Switching Times						
td(on)	Turn-on Delay Time	VGS=10V,VDS=50V, ID=20A,RGEN=3Ω	--	17	--	nS
tr	Turn-on Rise Time		--	4.0	--	nS
td(off)	Turn-Off Delay Time		--	30	--	nS
tf	Turn-Off Fall Time		--	8.0	--	nS
Qg	Total Gate Charge	VGS=10V, VDS=50V, ID=20A	--	36.5	--	nC
Qgs	Gate-Source Charge		--	7.0	--	nC
Qgd	Gate-Drain Charge		--	9.0	--	nC
Source-Drain Diode Characteristics						
ISD	Source-Drain Current(Body Diode)		--	--	80	A
VSD	Forward on Voltage	VGS=0V,IS=20A	--	0.9	1.0	V
trr	Reverse Recovery Time	IF=20A , dI/dt=100A/μs , TJ=25°C	--	53.4	--	ns
Qrr	Reverse Recovery Charge		--	62	--	nc

Notes 1.The maximum current rating is package limited.

Notes 2.Repetitive Rating: Pulse width limited by maximum junction temperature

Notes 3.EAS condition: T_J=25°C

Typical Performance Characteristics

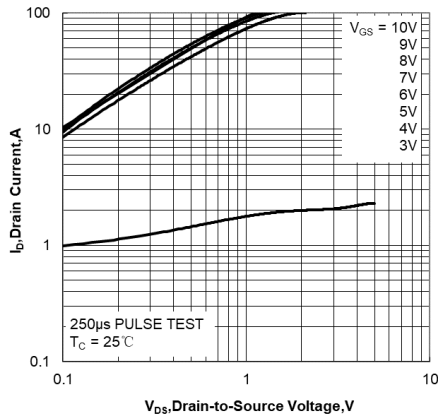

Figure 1. Output Characteristics

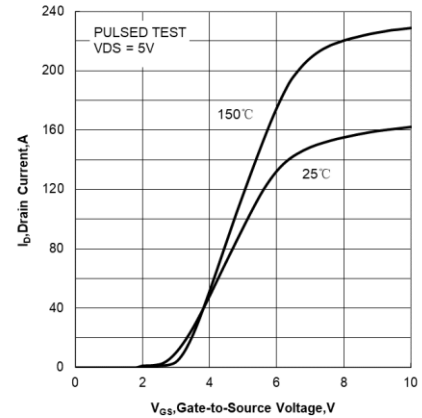

Figure 2. Transfer Characteristics

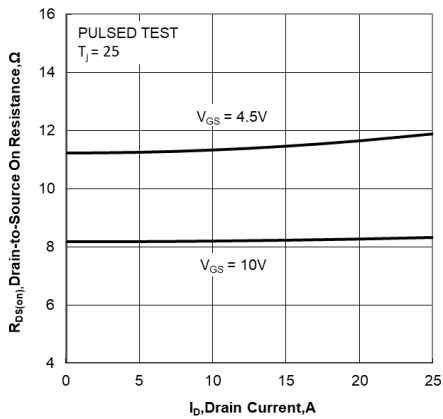

Figure 3. Drain-to-Source On Resistance vs Drain Current

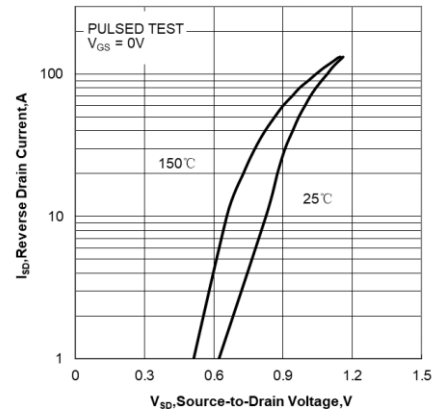

Figure 4. Body Diode Forward Voltage vs Source Current and Temperature

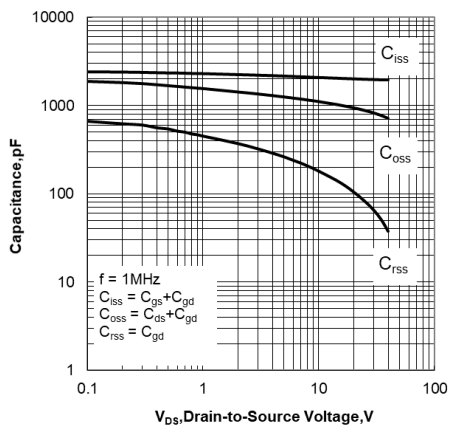

Figure 5. Capacitance Characteristics

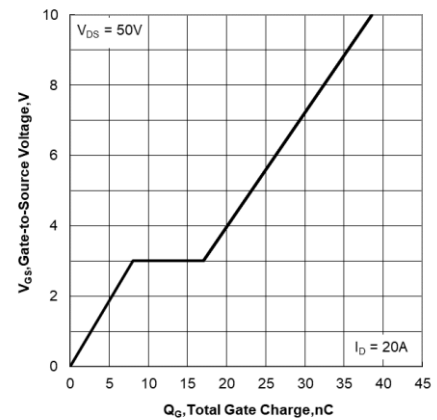

Figure 6. Gate Charge Characteristics

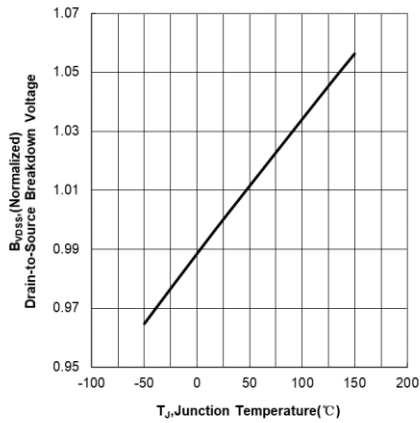

Figure 7. Normalized Breakdown Voltage vs Junction Temperature

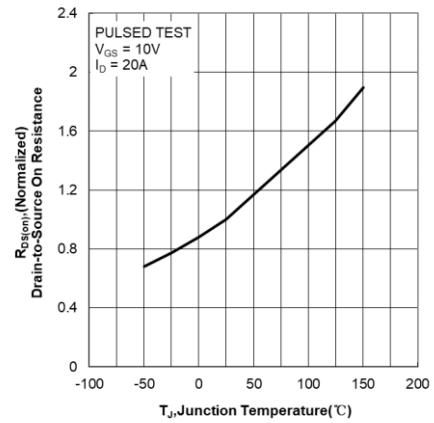

Figure 8. Normalized On Resistance vs Junction Temperature

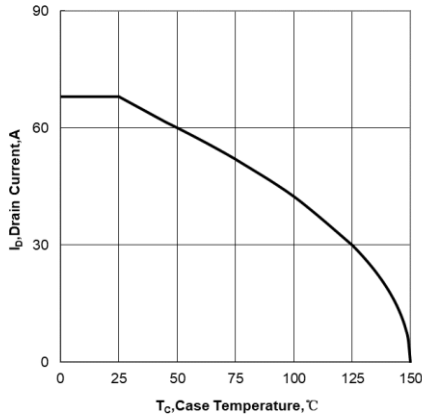

Figure 9. Maximum Continuous Drain Current vs Case Temperature

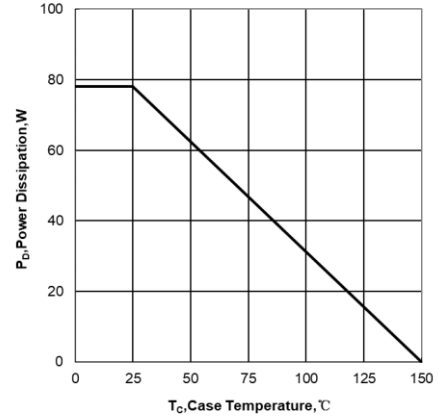

Figure 10. Maximum Power Dissipation vs Case Temperature

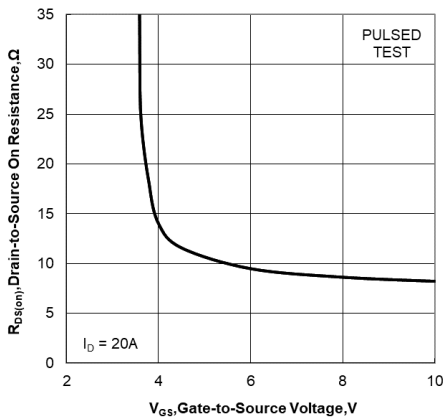

Figure 11. Drain-to-Source On Resistance vs Gate Voltage and Drain Current

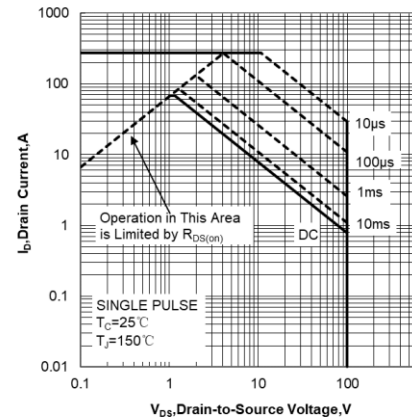

Figure 12. Maximum Safe Operating Area

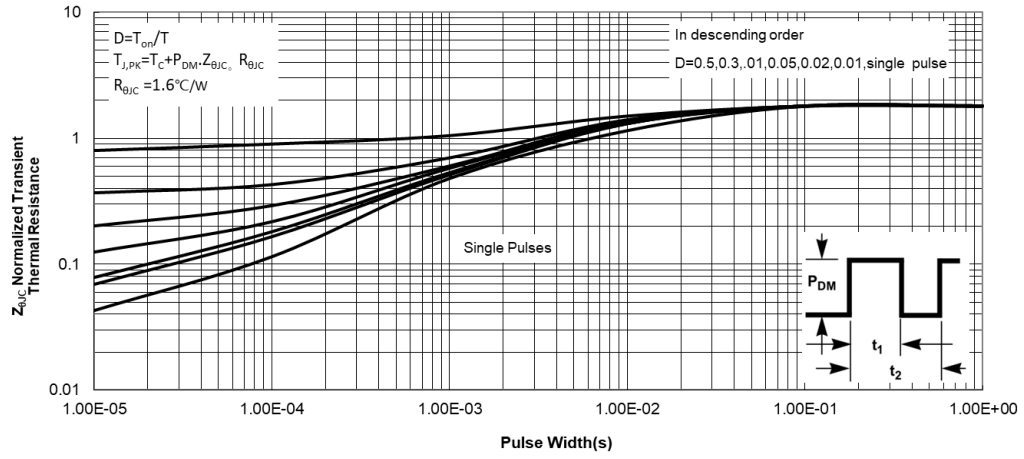
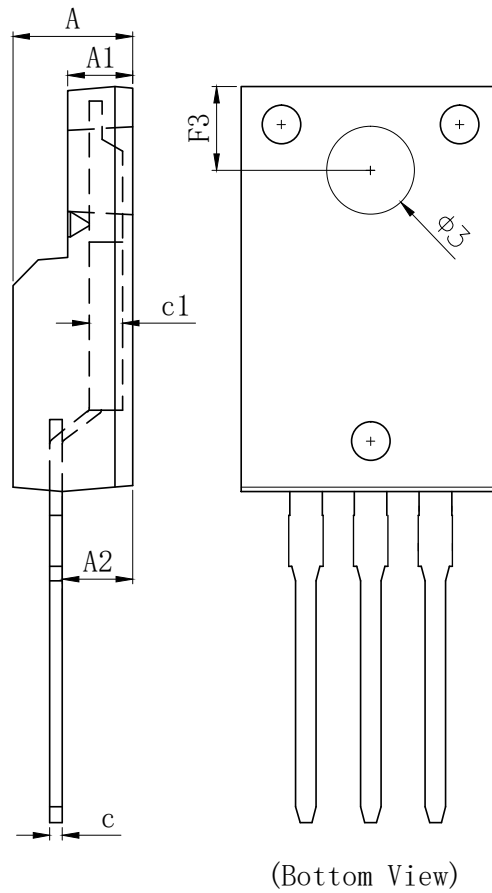
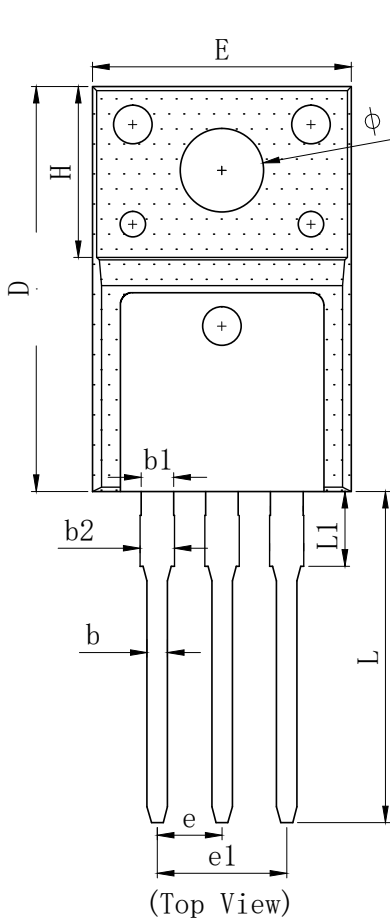
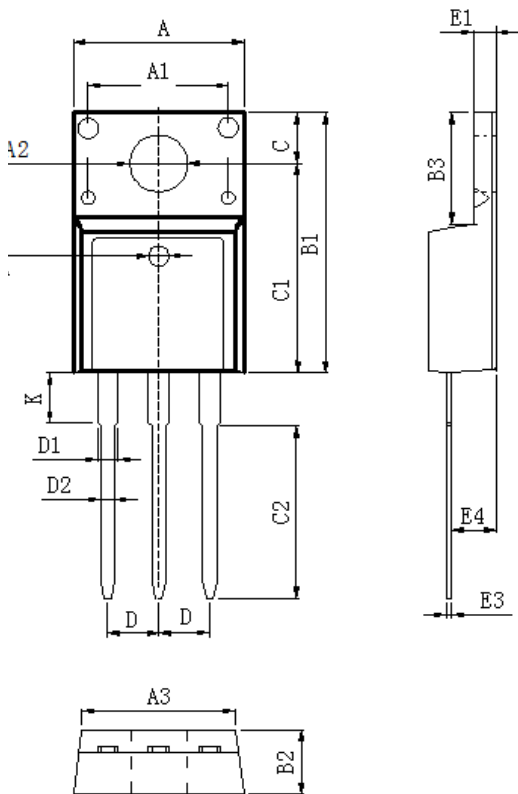

Figure 13. Maximum Effective Transient Thermal Impedance, Junction-to-Case

TO-220F Package Mechanical Data



SYMBOL	MILLIMETER		
	MIN	Typ.	MAX
A	4.500	4.700	4.900
A1	2.340	2.540	2.740
A2	2.560	2.760	2.960
b	0.700	0.800	0.950
b1	1.180	1.280	1.430
b2	1.250	1.350	1.550
c	0.400	0.500	0.650
c1	1.200	1.300	1.350
D	15.570	15.870	16.170
H	6.700 REF		
E	9.960	10.160	10.360
e	2.540 BSC		
e1	5.080 BSC		
L	12.680	12.980	13.280
L1	2.780	2.930	3.080
F3	3.150	3.300	3.450
φ	3.030	3.180	3.450
φ3	3.150	3.450	3.650



DIM	MILLIMETERS
A	10.16 ± 0.3
A1	7.00 ± 0.1
A2	3.3 ± 0.2
A3	9.5 ± 0.2
B1	15.87 ± 0.3
B2	4.7 ± 0.2
B3	6.68 ± 0.4
C	3.3 ± 0.2
C1	12.57 ± 0.3
C2	10.02 ± 0.5
D	2.54 ± 0.05
D1	1.28 ± 0.2
D2	0.8 ± 0.1
K	3.1 ± 0.3
E1	2.54 ± 0.1
E3	0.5 ± 0.1
E4	2.76 ± 0.2
DIA	⊙1.5 (deep 0.2)

Unit :mm

Disclaimer:

The information provided in this document is believed to be accurate and reliable. however, Shenzhen Core Control Electronics Technology Co., Ltd. does not assume any responsibility for the following consequences. Do not consider the use of such information or use beyond its scope.

The information mentioned in this document may be changed at any time without notice.

The products and information provided in this document do not infringe patents. Shenzhen Core Control Electronics Technology Co., Ltd. assumes no responsibility for any infringement of any other rights of third parties. The result of using such products and information.

This document is the third version issued on April 10, 2023. This document replaces all previously provided information.

 It is a registered trademark of Shenzhen Core Control Electronics Technology Co., Ltd.

Copyright © 2017 Shenzhen Core Control Electronics Technology Co., Ltd. all rights reserved.