

## IVST12020DB1L – 1200V 10A\*2 SiC MODULE

### Features

- Max Junction Temperature 175°C
- High Surge Current Capacity
- Zero Reverse Recovery Current
- Zero Forward Recovery Voltage
- High-Frequency Operation
- Temperature independent switching behavior
- Positive Temperature Coefficient on  $V_F$

### Package

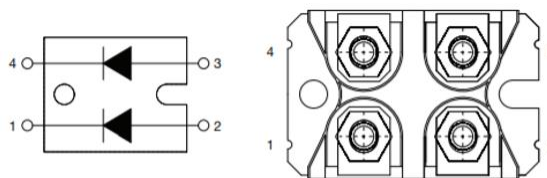

### Applications

- Inverter Free Wheeling Diodes
- Snubber Diodes
- Rectifiers in Switch Mode Power Supplies
- UPS application

Part Number	Package
IVST12020DB1L	SOT 227

### Absolute Maximum Ratings (Per SBD/Tc=25°C unless otherwise specified)

Symbol	Parameter	Value	Unit
$V_{RRM}$	Reverse voltage (repetitive peak)	1200	V
$V_{DC}$	DC blocking voltage	1200	V
$I_F$	Forward current (continuous) @Tc=25°C	29	A
	Forward current (continuous) @Tc=135°C	14	A
	Forward current (continuous) @Tc=152°C	10	A
$I_{FSM}$	Surge non-repetitive forward current sine halfwave @Tc=25°C tp=10ms	72	A
$I_{FRM}$	Surge repetitive forward current (Freq=0.1Hz, 100cycles) sine halfwave @Tamb=25°C tp=10ms	56	A
$P_{tot}$	Total power dissipation @ Tc=25°C	151	W
	Total power dissipation @ Tc=150°C	25	
$\int i^2 dt$	$I^2t$ value @Tc=25°C tp=10ms	26	A <sup>2</sup> s
Tstg	Storage temperature range	-55 to 175	°C
Tj	Operating junction temperature range	-55 to 175	°C

Stresses exceeding those listed in the Maximum Ratings table may damage the device. If any of these limits are exceeded, device functionality should not be assumed, damage may occur and reliability may be affected.

## Electrical Characteristics (Per SBD)

Symbol	Parameter	Typ.	Max.	Unit	Test Conditions	Note
V <sub>F</sub>	Forward Voltage	1.48	1.7	V	I <sub>F</sub> = 10 A T <sub>J</sub> =25°C	Fig. 1
		2.0	3.0		I <sub>F</sub> = 10 A T <sub>J</sub> =175°C	
I <sub>R</sub>	Reverse Current	1	100	μA	V <sub>R</sub> = 1200 V T <sub>J</sub> =25°C	Fig. 2
		10	250		V <sub>R</sub> = 1200 V T <sub>J</sub> =175°C	
C	Total Capacitance	575		pF	V <sub>R</sub> = 1 V, T <sub>J</sub> = 25°C, f = 1 MHz	Fig. 3
		59			V <sub>R</sub> = 400 V, T <sub>J</sub> = 25°C, f = 1 MHz	
		42.5			V <sub>R</sub> = 800 V, T <sub>J</sub> = 25°C, f = 1 MHz	
Q <sub>c</sub>	Total Capacitive Charge	62		nC	V <sub>R</sub> = 800 V, T <sub>J</sub> = 25°C, $Q_c = \int_0^{V_R} C(V) dV$	Fig. 4
E <sub>c</sub>	Capacitance Stored Energy	16.8		μJ	V <sub>R</sub> = 800 V, T <sub>J</sub> = 25°C, $E_c = \int_0^{V_R} C(V) \cdot V dV$	Fig. 5

## Thermal Characteristics (Per SBD)

Symbol	Parameter	Typ.	Unit	Note
R <sub>th(j-c)</sub>	Thermal Resistance from Junction to Case	0.988	°C/W	Fig.7

## Module Characteristics

Symbol	Parameter	Conditions	Value			Unit
			Min.	Typ.	Max.	
V <sub>ISOL</sub>	Isolation test voltage	RMS, f=50Hz, t=1min			2.5	kV
T <sub>stg</sub>	Storage temperature		-40		150	°C
M	Terminal connection torque	Screw M4	1.1		1.5	N·m
	Mounting torque	Screw M4	1.1		1.5	N·m
G	Weight of module			27		g
	Creepage distance	Terminal to heatsink		10.61		mm
		Terminal to terminal		10.37		mm
	Clearance	Terminal to heatsink		6.7		mm
		Terminal to terminal		4.05		mm

### Typical Performance (Per SBD)

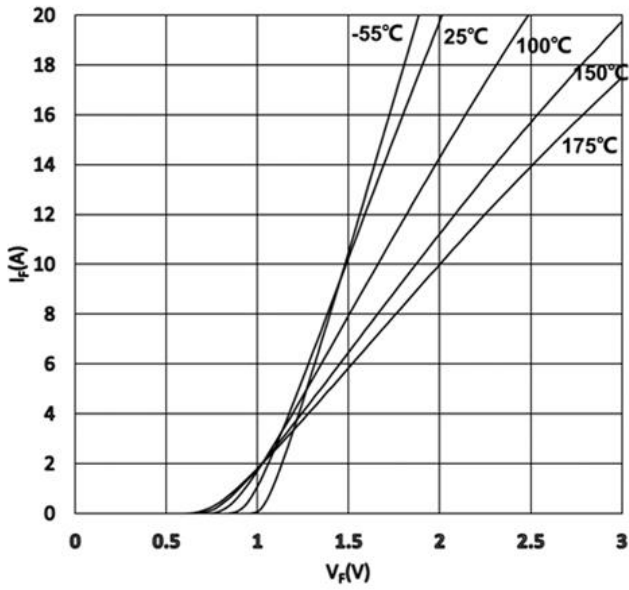

Figure 1. Typical Forward Characteristics

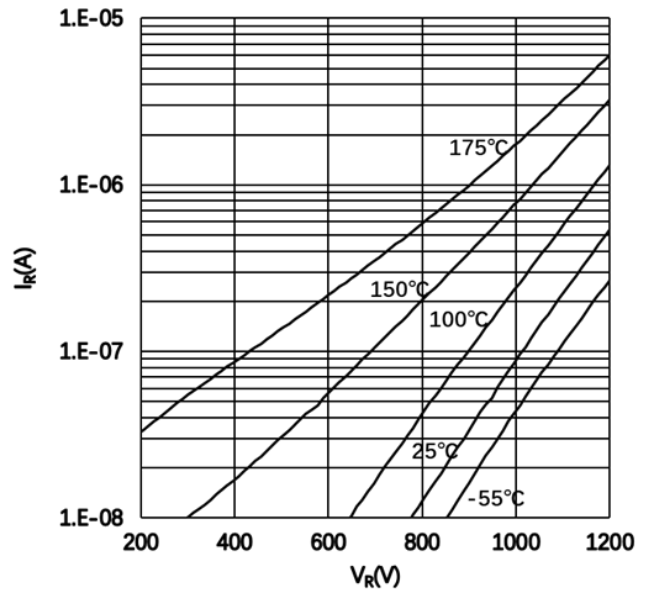

Figure 2. Typical Reverse Characteristics

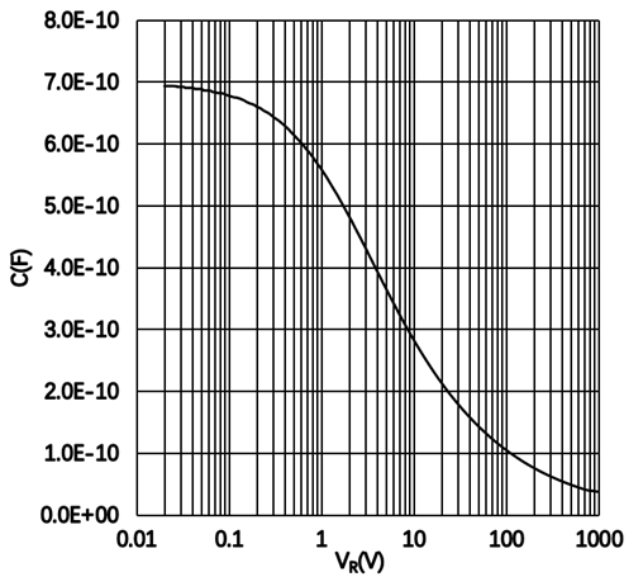

Figure 3. Capacitance vs. Reverse Voltage

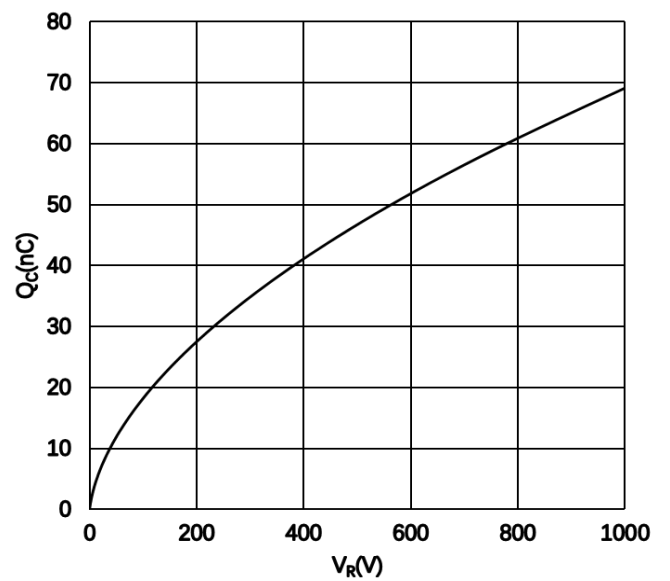

Figure 4. Recovery Charge vs. Reverse Voltage

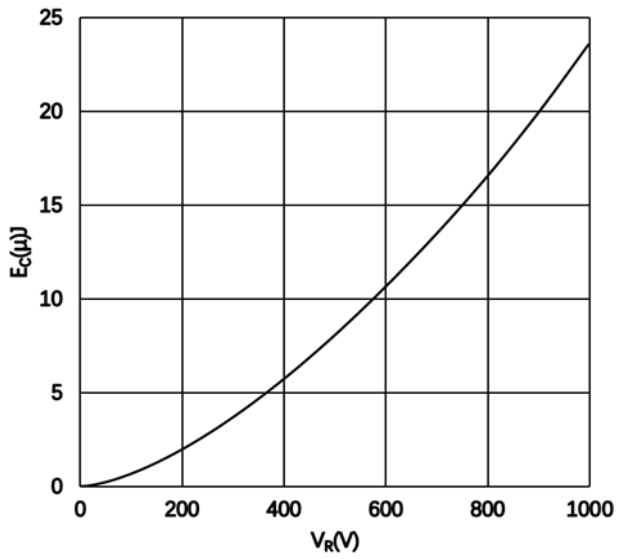

Figure 5. Capacitance Stored Energy

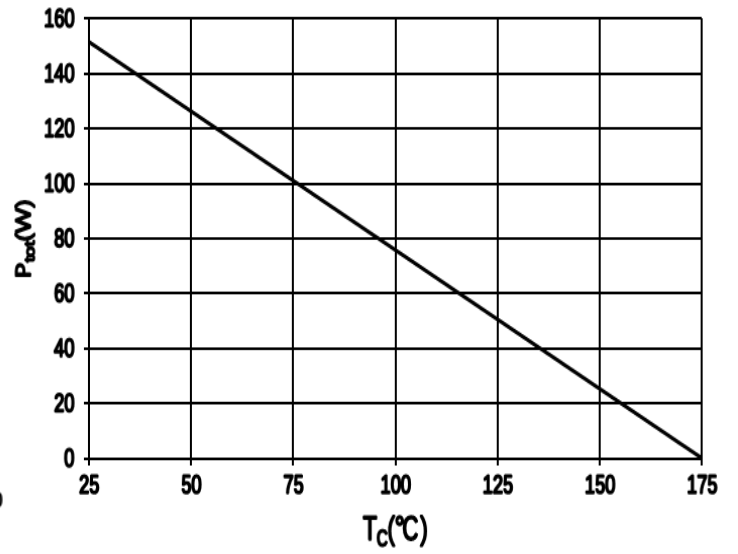

Figure 6. Power Derating

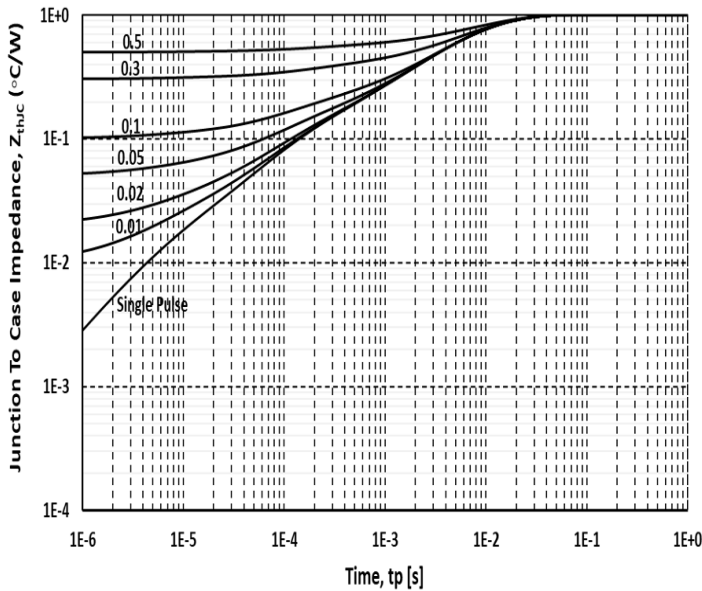

Figure 7. Transient Thermal Impedance

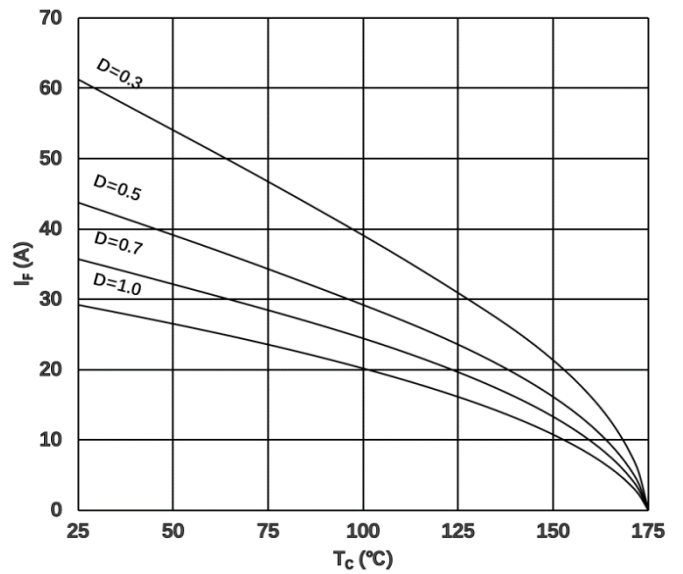
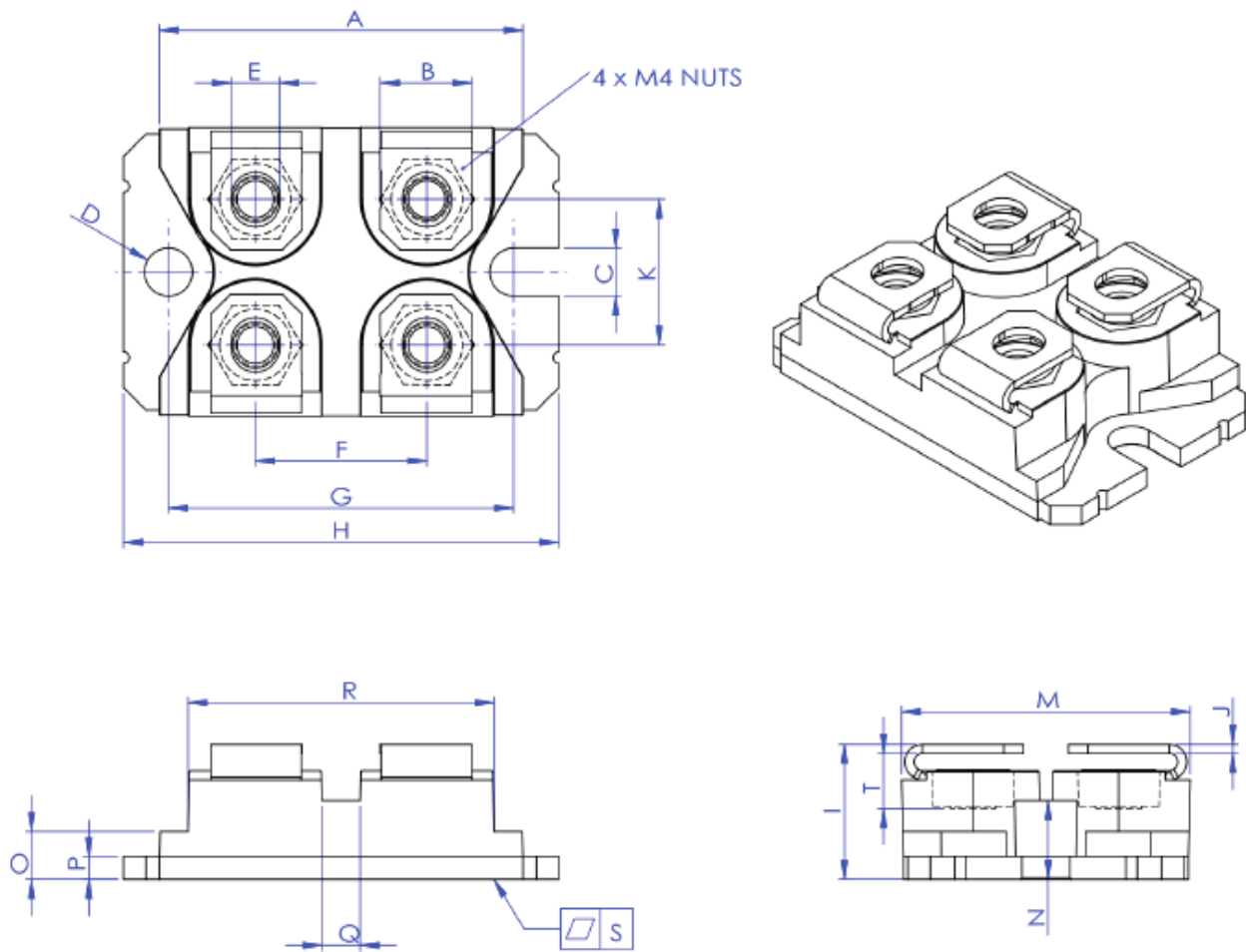

Figure 8. Forward Current as a Function of Temp

## Package Dimensions



Dimension	Millimeter		Typical
	Min	Max	
A	31.50	32.00	31.70
B	7.70	8.30	8.00
C	4.10	4.30	4.20
D	4.10	4.30	4.20
E	4.10	4.30	4.20
F	14.90	15.15	15.0
G	29.80	30.40	30.10
H	37.80	38.30	38.05
I	11.80	12.30	12.05
J	0.75	0.85	0.80
K	12.50	13.00	12.75
M	25.00	25.50	25.30
N	6.75	7.10	6.90
O	4.00	4.40	4.20
P	1.90	2.10	2.00
Q	3.20	3.60	3.40
R	26.60	27.00	26.80
S	-0.03	0.10	0.01
T	4.85	5.25	5.05

## Notes

For further information please contact IVCT's Office.

Copyright©2022 InventChip Technology Co., Ltd. All rights reserved.

The information in this document is subject to change without notice.

## Related Links

<http://www.inventchip.com.cn>

