

REV.	ECN Number	Description	Drawn
1	E17070069	RELEASE	XPG_2017.07.20
②	E18030021	ADD PART NUMBER	XPG_2018.03.26
③	E18050026	DEFINE PIN NO.	XPG_2018.05.23
④	E19010035	ADD PLATING CODE:Z	XPG_2019.01.22
⑤	E19110007	ADD PLATING CODE:3	WSY_2019.11.01
⑥	E20060033	CORRECT PRODUCT NUMBER MATRIX	Peak_2020.06.07
⑦	E20070009	BA42-XXAT ADD DATE CODE	Peak_2020.07.06
⑧	E22070023	ADD 120Pin etc.	Peak_2022.07.29

NOTES: (UNLESS OTHERWISE SPECIFIED)
 1. DIMENSION SHALL BE INTERPRETED PER ASME Y14.5M-2009
 2. MATERIAL:
 HOUSING MATERIAL: HIGH TEMPERATURE PLASTICS.
 CONTACT MATERIAL: COPPER ALLOY,
 VACUUM COVER MATERIAL: STAINLESS STEEL.
 3. PRODUCT NUMBER MATRIX:

Series code: B A 4 2-XX X T-X X -X H X
 0.80 Pitch
 Receptacle
 PIN No.: N
 40~80:40~80PIN
 A0:100PIN
 C0:120PIN
 E0:140PIN
 Height
 B: H=7.75mm
 C: H=11.75mm
 Soldering Type
 T:SMT
 0:Without Chamfer
 1:With Chamfer
 Housing Color
 Null:Nature
 B:Black

Packing:
 B:REEL+MPAD
 Q:HOT SEALING
 REEL+MPAD
 H:Halogen free
 Plating

Definition	Code
Contact area:8u"	Z
Solder area:GF	
⊙ Duplex plated	
flash	K 1u" S 3u" L
5u"	M 10u" N 15u" P
20u"	Q 25u" T 30u" U
2u"	3
⊙ All plated is lead free.	

PIN NO.	CIRCUITS	DIM.A	DIM.B	DIM.C	DIM.D	DIM.E	DIM.G
40	40PIN	15.20	21.80	20.20	20.10	18.7	0.10
60	60PIN	23.20	29.80	28.20	28.10	26.7	
80	80PIN	31.20	37.80	36.20	36.10	34.7	
A0	100PIN	39.20	45.80	44.20	44.10	42.70	0.12
C0	120PIN	47.20	53.80	52.20	52.10	50.76	
E0	140PIN	55.20	61.80	60.20	60.10	58.76	



TOLERANCE UNLESS OTHERWISE SPECIFIED			
X.X	±0.30	X.°	±3°
X.XX	±0.20	X.X°	±2°
X.XXX		X.XX°	±1°

SCALE	1:1
UNIT	mm
SIZE	A4

ORIGINAL DRAWN: Peak
 CHECK: Xu Peiguang
 APPROVE: Ady Zhou

DATE 2022.07.29
 DATE 2022.07.29
 DATE 2022.07.29

DWG. NO. 600-0000-0223
 PARTS NO. (INTENDED USE) BA42-XXXT-XX-XHX

TITLE 0.80 Pitch BTB Receptacle SMT

REV. 8
 SHEET 1/3

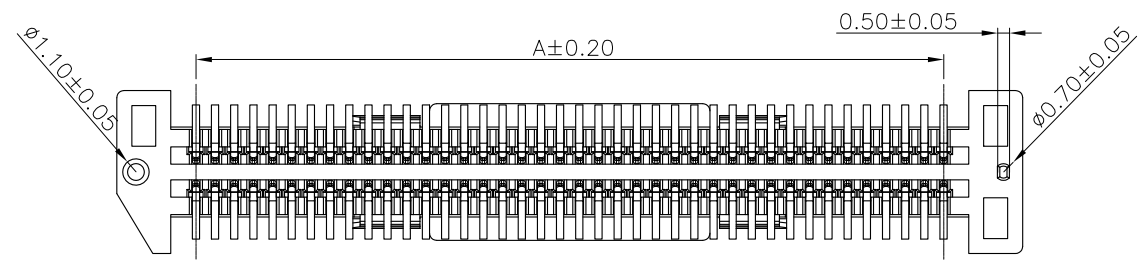
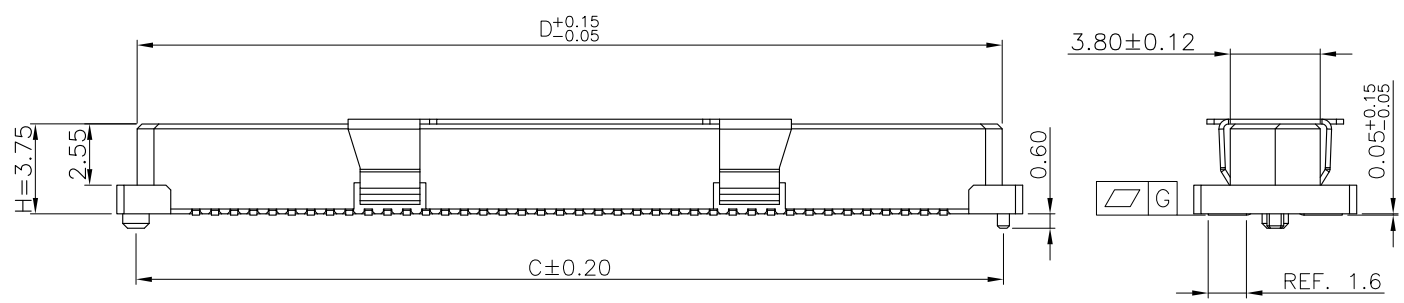
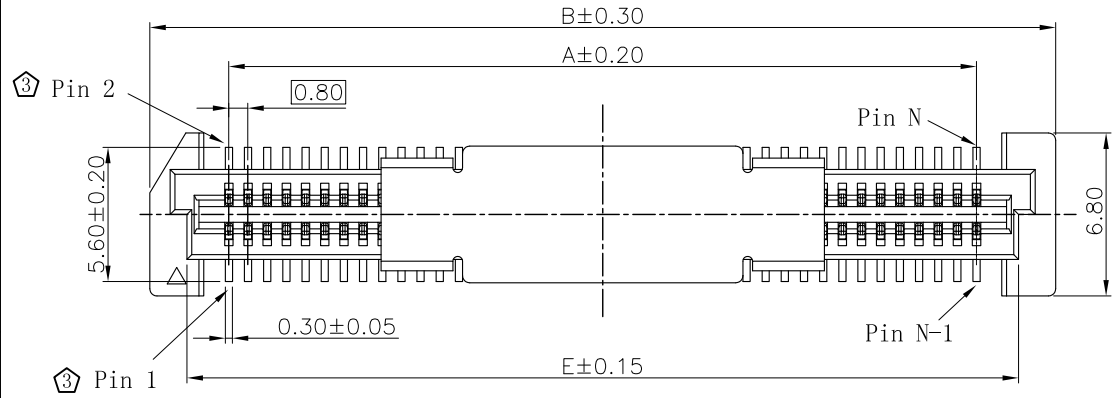

NOTES: (UNLESS OTHERWISE SPECIFIED)
 1. DIMENSION SHALL BE INTERPRETED PER ASME Y14.5M-2009
 2. MATERIAL:
 HOUSING MATERIAL: HIGH TEMPERATURE PLASTICS.
 CONTACT MATERIAL: COPPER ALLOY,
 VACUUM COVER MATERIAL: STAINLESS STEEL.
 3. PRODUCT NUMBER MATRIX:

Series code: B A 4 2-XX X T-1 X -X H X

0.80 Pitch
 Receptacle
 PIN No.: N
 40: 40PIN
 80: 80PIN

Height
 A: H=3.75mm

Soldering Type
 T: SMT
 1: With Chamfer

Housing Color
 Null: Nature
 B: Black

Packing:
 B: REEL+MPAD
 Q: HOT SEALING
 REEL+MPAD
 H: Halogen free
 Plating

Definition	Code
Contact area: 8u"	Z
Solder area: GF	
© Duplex plated	
flash	K
1u"	S
3u"	L
5u"	M
10u"	N
15u"	P
20u"	Q
25u"	T
30u"	U
2u"	3
© All plated is lead free.	

PIN NO.	CIRCUITS	DIM.A	DIM.B	DIM.C	DIM.D	DIM.E	DIM.G
40	40PIN	15.20	21.80	20.20	20.10	18.7	0.10
80	80PIN	31.20	37.80	36.20	36.10	34.7	0.12



TOLERANCE UNLESS OTHERWISE SPECIFIED			
X.X	±0.30	X.°	±3°
X.XX	±0.20	X.X°	±2°
X.XXX		X.XX°	±1°

SCALE	1:1
UNIT	mm
SIZE	A4

ORIGINAL DRAWN: Peak
 CHECK: Xu Peiguang
 APPROVE: Ady Zhou

DATE: 2022.07.29
 DATE: 2022.07.29
 DATE: 2022.07.29

DWG. NO. 600-0000-0223
 PARTS NO. (INTENDED USE) BA42-XXXT-XX-XHX

TITLE: 0.80 Pitch BTB Receptacle SMT

REV. 8
 SHEET 2/3

PRODUCT NUMBER MATRIX: BA42-XXXT-XX-XHX

0: Without Chamfer
1: With Chamfer

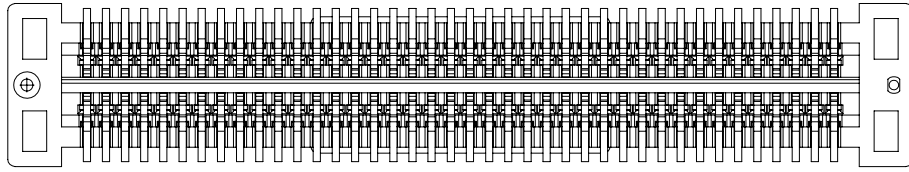

BA42-XXXT-0X-XHX

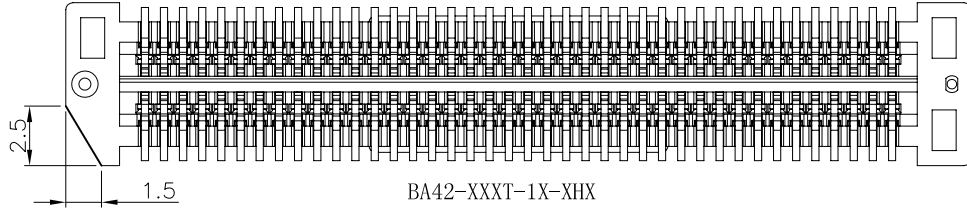

BA42-XXXT-1X-XHX

②

OLD AND PART NO. COMPARISION	
OLD	NEW
ZIV-40S4-VN-1-B	BA42-40CT-0-NHB
ZIV-80S4-N-1-B	BA42-80CT-0-NHB
ZIV80S4N1B	
AB42-80NB-H-003	
AB42-80NB-1-003	BA42-80CT-1-NHB
ZIV-40S5-N-1-B-S01	BA42-40BT-1-NHB
ZIV-80S5-N-1-B-S01	BA42-80BT-1-NHB
AB42-80NB-H-001	BA42-80AT-1-NHB
AB42-A0NB-H-002	BA42-A0BT-0-NHB

RECOMMENDED PCB LAYOUT

TOLERANCE ± 0.05

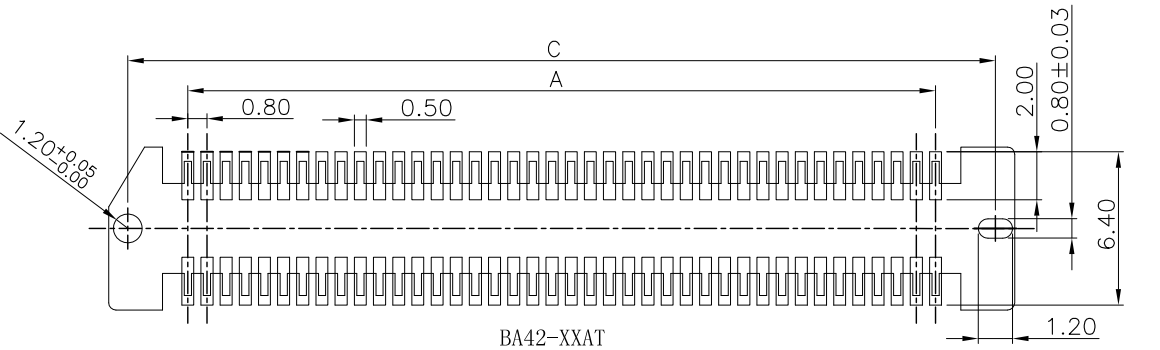
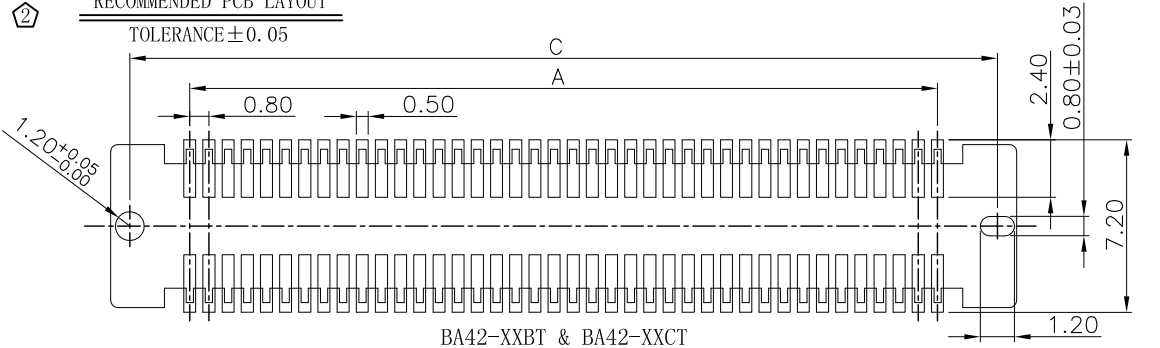

⑧

PIN NO.	CIRCUITS	DIM.A	DIM.C
40	40PIN	15.20	20.20
60	60PIN	23.20	28.20
80	80PIN	31.20	36.20
A0	100PIN	39.20	44.20
C0	120PIN	47.20	52.20
E0	140PIN	55.20	60.20



ShenZhen ShenTai weixiang Electronics Co., Ltd.

TOLERANCE UNLESS OTHERWISE SPECIFIED

X.X	± 0.30	X.°	$\pm 3^\circ$
X.XX	± 0.20	X.X°	$\pm 2^\circ$
X.XXX		X.XX°	$\pm 1^\circ$

SCALE	1:1
UNIT	mm
SIZE	A4

ORIGINAL DRAWN: Peak
CHECK: Xu Peiguang
APPROVE: Ady Zhou

DATE 2022.07.29
DATE 2022.07.29
DATE 2022.07.29

DWG. NO. 600-0000-0223
PARTS NO. (INTENDED USE) BA42-XXXT-XX-XHX

TITLE 0.80 Pitch BTB Receptacle SMT

REV. 8
SHEET 3/3