

»Features

- Excellent clamping capability
- Low leakage current
- Low capacitance
- High surge capability
- Glass passivated chip
- Epoxy resin package
- Built-in strain relief
- Will not fatigue
- RoHS Compliant
- Fast response time:
typically less than 1.0ps from 0 Volts to V_{BR} min



SMA (DO-214AC)

»Mechanical Characteristics

- Package: SMA plastic package.
- Lead Finish: Matte Tin
- Case Material: Epoxy Molding Compound.
- UL Flammability Classification Rating 94V-0
- Moisture Sensitivity: Level 1 per J-STD-020

»Applications

- Telecom
- Computer
- Industrial electronic
- Consumer electronic

»Electrical Parameters

Parameter	Definition
C_J	Junction Capacitance - typical capacitance measured with 0V or V_R bias
I_{PP}	Peak Pulse Current - maximum rated peak impulse current
V_C	Clamping Voltage - Peak voltage measured across the suppressor at a specified I_{ppm} (peak impulse current)
V_{BR}	Breakdown Voltage - Maximum voltage that flows through the TVS at a specified test current (I_T)
I_R	Leakage Current - maximum peak off-state current measured at V_R
V_R	Peak Off-state Voltage - maximum voltage that can be applied while maintaining off state

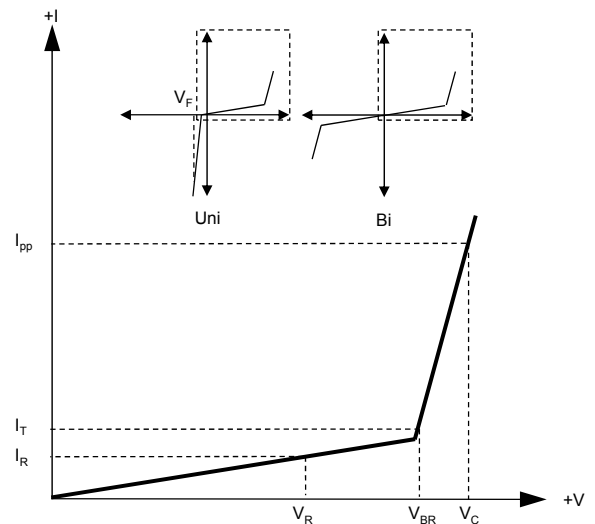

»Summary of Packing Options

Package	Packing Description	Packing Quantity	Industry Standard
SMA	Tape/Reel, 13" reel	5000	EIA-481-1
	Tape/Reel, 7" reel	2000	EIA-481-1

»Absolute Maximum Ratings ($T_A=25^{\circ}\text{C}$ unless otherwise noted)

Parameter	Symbol	Value	Units	Remarks
Peak Pulse Power Dissipation	P_{PPM}	400	W	(Note1)(Note2)
Steady State Power Dissipation	P_D	3.3	W	(Note3)
Peak Forward Surge Current	I_{FSM}	40	A	(Note4)
Maximum Instantaneous Forward Voltage at 20A	V_{FM}	3.5/6.5	V	(Note5)
Typical Thermal Resistance Junction to Lead	$R_{\theta JL}$	30	$^{\circ}\text{C}/\text{W}$	
Typical Thermal Resistance Junction to Ambient	$R_{\theta JA}$	120	$^{\circ}\text{C}/\text{W}$	
Operating Temperature Range	T_J	-55 to 150	$^{\circ}\text{C}$	
Storage Temperature Range	T_{STG}	-55 to 150	$^{\circ}\text{C}$	

Notes1: Non-repetitive current pulse , 10/1000us Waveform.

Notes2: Mounted on copper pad area of 5×5mm to each terminal.

Notes3: Infinite HeatSink at $T_A=50^{\circ}\text{C}$

Notes4: Measured on 8.3ms single half sine wave or equivalent square wave, duty cycle=4 perminute maximum.

Notes5: For UnidirectionalOnly, $V_{FM}<3.5\text{V}$ for $V_{BR} \leq 200\text{V}$ and $V_{FM}<6.5\text{V}$ for $V_{BR} \geq 201\text{V}$.

»Electrical Characteristics ($T_A=25^{\circ}\text{C}$ unless otherwise noted)

Part Number (Uni)	Part Number (Bi)	Marking Code		Reverse Stand off Voltage V_R (V)	Breakdown Voltage $V_{BR} @ I_T$ (V)		Test Current I_T (mA)	Maximum Clamping Voltage $V_C @ I_{PP}$ (V)	Maximum Peak Pulse Current I_{PP} (A)	Maximun Reverse Leakage $I_R @ V_R$ (μA)
		Uni	Bi		Min	Max				
SMAJ5.0A	SMAJ5.0CA	HE	TE	5	6.4	7	10	9.2	43.5	800
SMAJ6.0A	SMAJ6.0CA	HG	TG	6	6.67	7.37	10	10.3	38.8	800
SMAJ6.5A	SMAJ6.5CA	HK	TK	6.5	7.22	7.98	10	11.2	35.7	500
SMAJ7.0A	SMAJ7.0CA	HM	TM	7	7.78	8.6	10	12	33.3	200
SMAJ7.5A	SMAJ7.5CA	HP	TP	7.5	8.33	9.21	1	12.9	31	100
SMAJ8.0A	SMAJ8.0CA	HR	TR	8	8.89	9.83	1	13.6	29.4	50
SMAJ8.5A	SMAJ8.5CA	HT	TT	8.5	9.44	10.4	1	14.4	27.8	20
SMAJ9.0A	SMAJ9.0CA	HV	TV	9	10	11.1	1	15.4	26	10
SMAJ10A	SMAJ10CA	HX	TX	10	11.1	12.3	1	17	23.5	5
SMAJ11A	SMAJ11CA	HZ	TZ	11	12.2	13.5	1	18.2	22	1
SMAJ12A	SMAJ12CA	IE	UE	12	13.3	14.7	1	19.9	20.1	1
SMAJ13A	SMAJ13CA	IG	UG	13	14.4	15.9	1	21.5	18.6	1
SMAJ14A	SMAJ14CA	IK	UK	14	15.6	17.2	1	23.2	17.2	1
SMAJ15A	SMAJ15CA	IM	UM	15	16.7	18.5	1	24.4	16.4	1
SMAJ16A	SMAJ16CA	IP	UP	16	17.8	19.7	1	26	15.4	1
SMAJ17A	SMAJ17CA	IR	UR	17	18.9	20.9	1	27.6	14.5	1
SMAJ18A	SMAJ18CA	IT	UT	18	20	22.1	1	29.2	13.7	1
SMAJ20A	SMAJ20CA	IV	UV	20	22.2	24.5	1	32.4	12.3	1
SMAJ22A	SMAJ22CA	IX	UX	22	24.4	26.9	1	35.5	11.3	1
SMAJ24A	SMAJ24CA	IZ	UZ	24	26.7	29.5	1	38.9	10.3	1

»Electrical Characteristics ($T_A=25^\circ\text{C}$ unless otherwise noted)

Part Number (Uni)	Part Number (Bi)	Marking Code		Reverse Stand off Voltage V_R (V)	Breakdown Voltage $V_{BR} @ I_T$ (V)		Test Current I_T (mA)	Maximum Clamping Voltage $V_C @ I_{PP}$ (V)	Maximum Peak Pulse Current I_{PP} (A)	Maximun Reverse Leakage $I_R @ V_R$ (μA)
		Uni	Bi		Min	Max				
SMAJ26A	SMAJ26CA	JE	VE	26	28.9	31.9	1	42.1	9.5	1
SMAJ28A	SMAJ28CA	JG	VG	28	31.1	34.4	1	45.4	8.8	1
SMAJ30A	SMAJ30CA	JK	VK	30	33.3	36.8	1	48.4	8.3	1
SMAJ33A	SMAJ33CA	JM	VM	33	36.7	40.6	1	53.3	7.5	1
SMAJ36A	SMAJ36CA	JP	VP	36	40	44.2	1	58.1	6.9	1
SMAJ40A	SMAJ40CA	JR	VR	40	44.4	49.1	1	64.5	6.2	1
SMAJ43A	SMAJ43CA	JT	VT	43	47.8	52.8	1	69.4	5.8	1
SMAJ45A	SMAJ45CA	JV	VV	45	50	55.3	1	72.7	5.5	1
SMAJ48A	SMAJ48CA	JX	VX	48	53.3	58.9	1	77.4	5.2	1
SMAJ51A	SMAJ51CA	JZ	VZ	51	56.7	62.7	1	82.4	4.9	1
SMAJ54A	SMAJ54CA	RE	WE	54	60	66.3	1	87.1	4.6	1
SMAJ58A	SMAJ58CA	RG	WG	58	64.4	71.2	1	93.6	4.3	1
SMAJ60A	SMAJ60CA	RK	WK	60	66.7	73.7	1	96.8	4.1	1
SMAJ64A	SMAJ64CA	RM	WM	64	71.1	78.6	1	103	3.9	1
SMAJ70A	SMAJ70CA	RP	WP	70	77.8	86	1	113	3.5	1
SMAJ75A	SMAJ75CA	RR	WR	75	83.3	92.1	1	121	3.3	1
SMAJ78A	SMAJ78CA	RT	WT	78	86.7	95.8	1	126	3.2	1
SMAJ85A	SMAJ85CA	RV	WV	85	94.4	104	1	137	2.9	1
SMAJ90A	SMAJ90CA	RX	WX	90	100	111	1	146	2.7	1
SMAJ100A	SMAJ100CA	RZ	WZ	100	111	123	1	162	2.5	1
SMAJ110A	SMAJ110CA	SE	XE	110	122	135	1	177	2.3	1
SMAJ120A	SMAJ120CA	SG	XG	120	133	147	1	193	2.1	1
SMAJ130A	SMAJ130CA	SK	XK	130	144	159	1	209	1.9	1
SMAJ150A	SMAJ150CA	SM	XM	150	167	185	1	243	1.6	1
SMAJ160A	SMAJ160CA	SP	XP	160	178	197	1	259	1.5	1
SMAJ170A	SMAJ170CA	SR	XR	170	189	209	1	275	1.5	1
SMAJ180A	SMAJ180CA	ST	XT	180	201	222	1	292	1.4	1
SMAJ200A	SMAJ200CA	SX	XX	200	224	247	1	324	1.2	1
SMAJ220A	SMAJ220CA	ZE	YE	220	246	272	1	356	1.1	1
SMAJ250A	SMAJ250CA	ZG	YG	250	279	309	1	405	1	1
SMAJ300A	SMAJ300CA	ZK	YK	300	335	371	1	486	0.8	1
SMAJ350A	SMAJ350CA	ZM	YM	350	391	432	1	567	0.7	1
SMAJ400A	SMAJ400CA	ZP	YP	400	447	494	1	648	0.6	1
SMAJ440A	SMAJ440CA	ZR	YR	440	492	543	1	713	0.6	1

»Rating And Characteristic Curves ($T_A=25^\circ\text{C}$ unless otherwise noted)

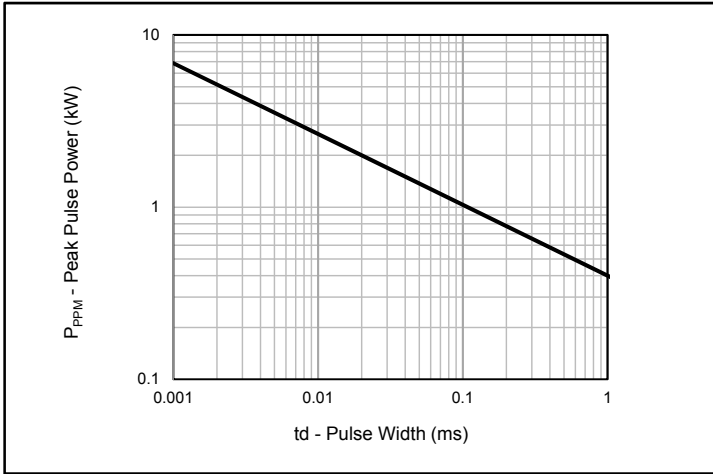

Fig.1 - Peak Pulse Power Rating

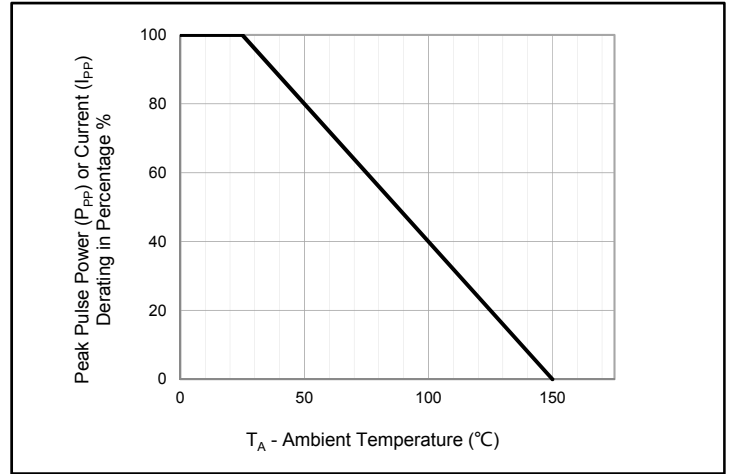

Fig.2 - Pulse Derating Curve

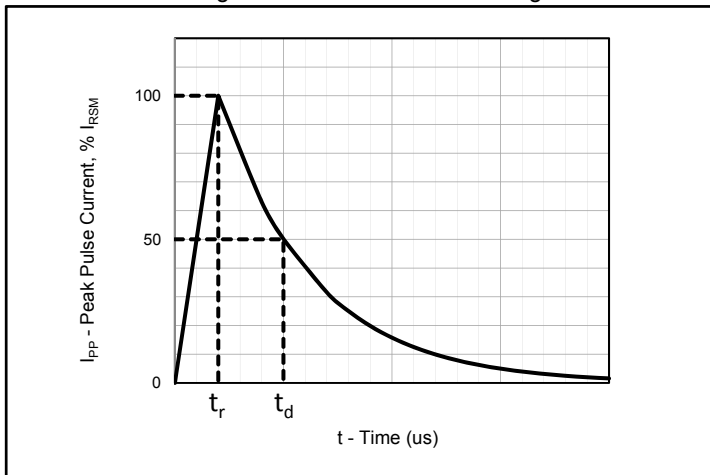

Fig.3 - Pulse Waveform

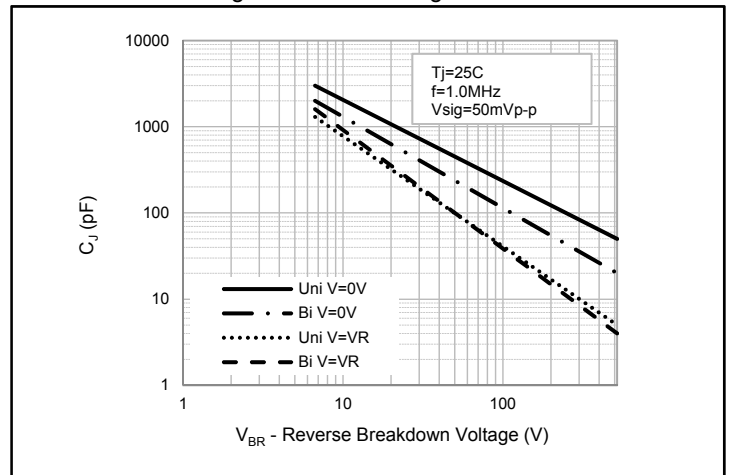

Fig.4 - Typical Junction Capacitance

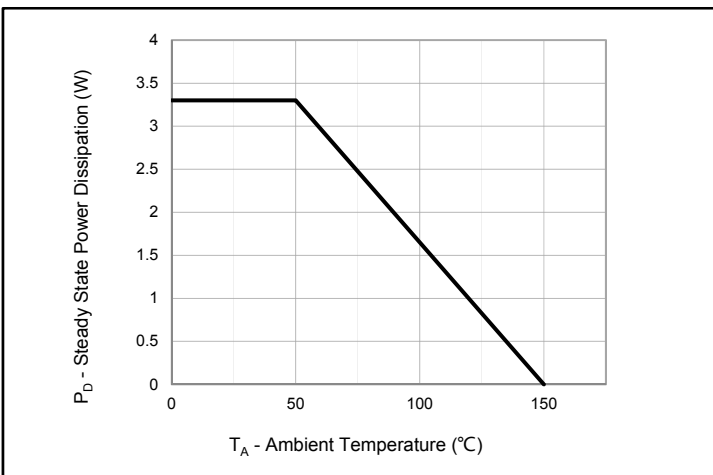

Fig.5 - Steady State Power Dissipation Derating Curve

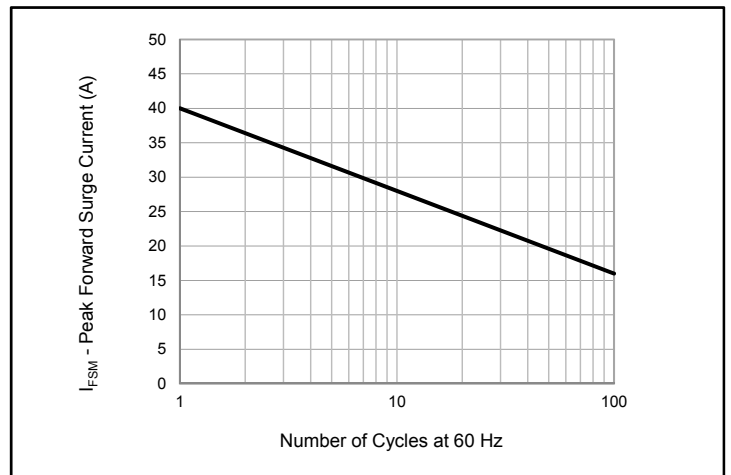
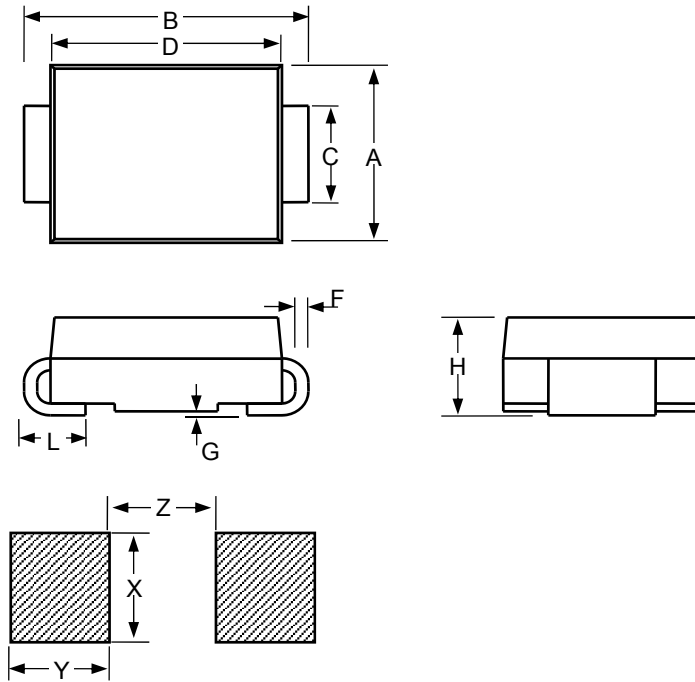

Fig.6 - Maximum Non-Repetitive Peak Forward Surge Current
Uni-Directional Only

»Package Dimensions



SMA						
Dimension	Inches			Millimeters		
	MIN	NOM	MAX	MIN	NOM	MAX
A	0.1		0.11	2.54		2.8
B	0.194		0.223	4.93		5.66
C	0.051		0.067	1.3		1.7
D	0.157		0.177	3.99		4.5
F	0.006		0.012	0.152		0.305
G	-		0.008	-		0.203
H	0.078		0.095	1.98		2.42
L	0.03		0.06	0.76		1.52
X		0.085			2.16	
Y		0.07			1.78	
Z		0.079			2	

»Marking Information

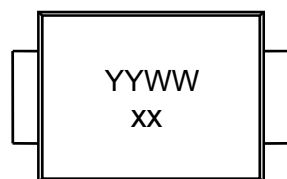

YYWW = Date Code
xx = Type Code

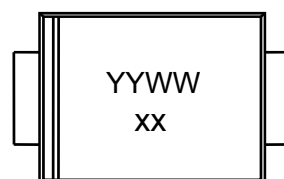

YYWW = Date Code
xx = Type Code

»Soldering Parameters



Reflow Condition		Lead-free assembly
Pre Heat	- Temperature Min ($T_{s(min)}$)	150°C
	- Temperature Max ($T_{s(max)}$)	200°C
	- Time (min to max) (t_s)	60 – 180 secs
Average ramp up rate (Liquidus Temp (T_L) to peak)		3°C/second max
$T_{s(max)}$ to T_L - Ramp-up Rate		3°C/second max
Reflow	- Temperature (T_L) (Liquidus)	217°C
	- Time (t_L)	60 – 150 secs
Peak Temperature (T_P)		260 ^{+0/-5} °C
Time within 5°C of actual peak Temperature (t_p)		20 – 40 secs
Ramp-down Rate		6°C/second max
Time 25°C to peak Temperature (t)		8 minutes Max.
Do not exceed		260°C

»Tape and Reel Specification

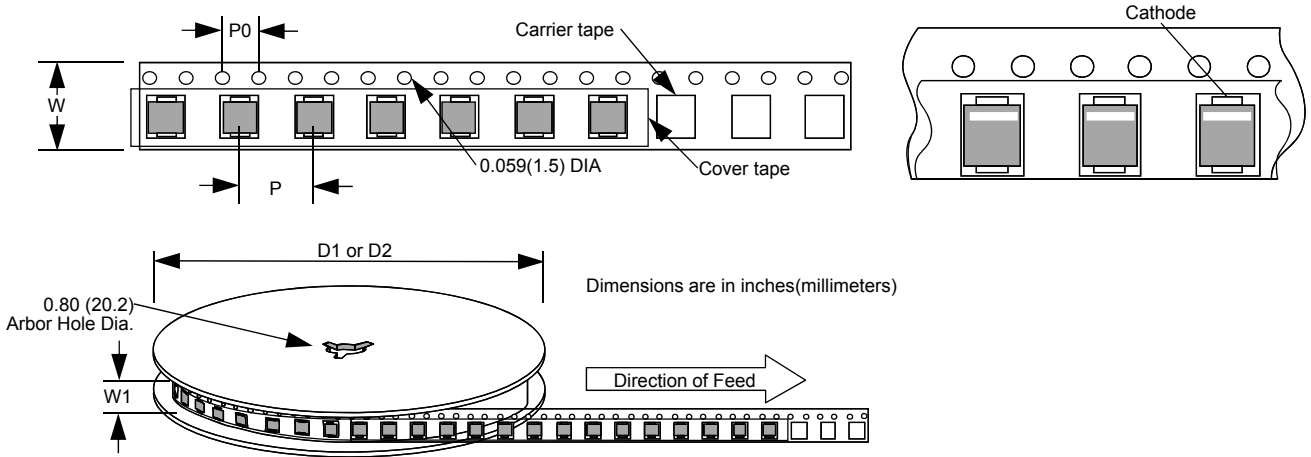

Dimension	Inches			Millimeters		
	MIN	NOM	MAX	MIN	NOM	MAX
P		0.157			4	
P0		0.157			4	
W		0.472			12	
W1		0.492			12.5	
D1		7			177.8	
D2		13			330.2	