

为您的产品保驾护航

PRODUCT DATASHEET

PTC Devices · Surface Mount

ASMD1812 Series Surface Mount PTC Devices

Description

The ASMD1812 series provides surface mount resettable overcurrent protection with holding current from 0.1A to 4.0A.

This series offers complete portfolio in terms of holding current and working voltage, and is suitable for wide range of applications.

Features

- RoHS compliant and lead-free
- Low profile
- Halogen-free
- Fast response to fault current
- Compact design saves board space
- Compatible with high temperature solders

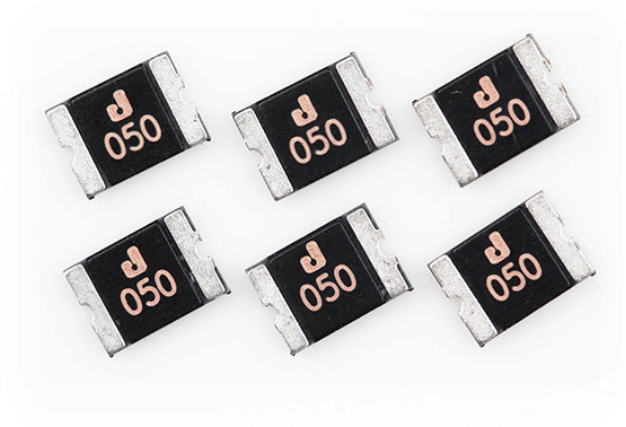

Applications

- USB hubs, ports and peripherals
- Motherboard USB & IEEE 1394 protection
- Set-top-box and HDMI
- Optical disk drives
- Game console port protection
- General electronics



Agency Approvals

Agency	File Number
	E472196

Regulation	Standard
	2002/95/EC
	EN14582

Performance Specification

Model	V _{max} (V dc)	I _{max} (A)	I _{hold} @25°C (A)	I _{trip} @25°C (A)	P _d Typ. (W)	Maximum Time To Trip		Resistance	
						Current (A)	Time (Sec)	R _{i min} (Ω)	R _{1max} (Ω)
ASMD1812-010	30.0	100	0.10	0.30	0.8	0.5	1.50	0.75	15.0
ASMD1812-010-33V	33.0	100	0.10	0.30	0.8	0.5	1.50	0.75	15.0
ASMD1812-010-60V	60.0	100	0.10	0.30	0.8	0.5	1.50	0.75	15.0
ASMD1812-014	60.0	100	0.14	0.34	0.8	1.5	0.15	0.65	6.00
ASMD1812-014-33V	33.0	100	0.14	0.34	0.8	1.5	0.15	0.65	6.00
ASMD1812-020	30.0	100	0.20	0.40	0.8	8.0	0.02	0.35	5.00
ASMD1812-020-33V	33.0	100	0.20	0.40	0.8	8.0	0.02	0.35	5.00
ASMD1812-020-60V	60.0	100	0.20	0.40	0.8	8.0	0.02	0.35	5.00
ASMD1812-030	30.0	100	0.30	0.60	0.8	8.0	0.10	0.25	3.00
ASMD1812-030-33V	33.0	100	0.30	0.60	0.8	8.0	0.10	0.25	3.00
ASMD1812-030-60V	60.0	100	0.30	0.60	0.8	8.0	0.10	0.25	3.00
ASMD1812-050	15.0	100	0.50	1.00	0.8	8.0	0.15	0.15	1.00
ASMD1812-050-33V	33.0	100	0.50	1.00	0.8	8.0	0.15	0.15	1.00
ASMD1812-050-60V	60.0	100	0.50	1.00	0.8	8.0	0.15	0.15	1.40
ASMD1812-075	13.2	100	0.75	1.50	0.8	8.0	0.20	0.09	0.45
ASMD1812-075-24V	24.0	100	0.75	1.50	0.8	8.0	0.20	0.09	0.45
ASMD1812-075-33V	33.0	100	0.75	1.50	0.8	8.0	0.20	0.09	0.45
ASMD1812-110	8.00	100	1.10	2.20	0.8	8.0	0.30	0.045	0.25
ASMD1812-110-16V	16.0	100	1.10	2.20	0.8	8.0	0.30	0.045	0.25
ASMD1812-110-24V	24.0	100	1.10	2.20	0.8	8.0	0.30	0.045	0.25
ASMD1812-110-33V	33.0	100	1.10	2.20	0.8	8.0	0.30	0.045	0.25
ASMD1812-125	16.0	100	1.25	2.50	0.8	8.0	0.40	0.05	0.20
ASMD1812-150	8.00	100	1.50	3.00	0.8	8.0	0.50	0.04	0.16
ASMD1812-150-12V	12.0	100	1.50	3.00	0.8	8.0	0.50	0.04	0.16
ASMD1812-150-24V	24.0	100	1.50	3.00	0.8	8.0	0.50	0.04	0.16
ASMD1812-160	8.00	100	1.60	2.80	0.8	8.0	1.00	0.03	0.13
ASMD1812-200	8.00	100	2.00	4.00	0.8	8.0	2.00	0.02	0.10
ASMD1812-200-16V	16.0	100	2.00	4.00	0.8	8.0	2.00	0.02	0.10
ASMD1812-200-24V	24.0	100	2.00	4.00	0.8	8.0	2.00	0.02	0.10
ASMD1812-200-30V	30.0	100	2.00	4.00	0.8	8.0	2.00	0.02	0.10
ASMD1812-260	8.00	100	2.60	5.00	0.8	8.0	2.50	0.01	0.05
ASMD1812-260-16V	16.0	100	2.60	5.00	0.8	8.0	2.50	0.01	0.05
ASMD1812-300	8.00	100	3.00	5.00	0.8	8.0	4.00	0.01	0.04
ASMD1812-300-12V	12.0	100	3.00	5.00	0.8	8.0	4.00	0.01	0.04
ASMD1812-300-16V	16.0	100	3.00	5.00	0.8	8.0	4.00	0.01	0.04
ASMD1812-350	6.00	100	3.50	6.00	2.0	10.0	4.00	0.008	0.035
ASMD1812-350-16V	16.0	100	3.50	6.00	2.0	10.0	4.00	0.008	0.035
ASMD1812-400	6.00	100	4.00	7.00	2.0	10.0	4.00	0.005	0.025

I_{hold} = Hold Current. Maximum current device will not trip in 25°C still air.

I_{trip} = Trip Current. Minimum current at which the device will always trip in 25°C still air.

V_{max} = Maximum operating voltage device can withstand without damage at rated current (I_{max}).

I_{max} = Maximum fault current device can withstand without damage at rated voltage (V_{max}).

P_d = Power dissipation when device is in the tripped state in 25°C still air environment at rated voltage.

$R_{i\ min/max}$ = Minimum/Maximum device resistance prior to tripping at 25°C.

$R_{1\ max}$ = Maximum device resistance is measured one hour post reflow.

CAUTION : Operation beyond the specified ratings may result in damage and possible arcing and flame.

Environmental Specifications

	Conditions	Resistance change
Passive aging	+85°C, 1000 hrs.	±5% typical
Humidity aging	+85°C, 85% R.H. , 168 hours	±5% typical
Thermal shock	+85°C to -40°C, 20 times	±33% typical
Resistance to solvent	MIL-STD-202,Method 215	No change
Vibration	MIL-STD-202,Method 201	No change
Ambient operating conditions : - 40 °C to +85 °C		
Maximum surface temperature of the device in the tripped state is 125 °C		

Thermal Derating Curve

Derating Curves for ASMD1812 Series

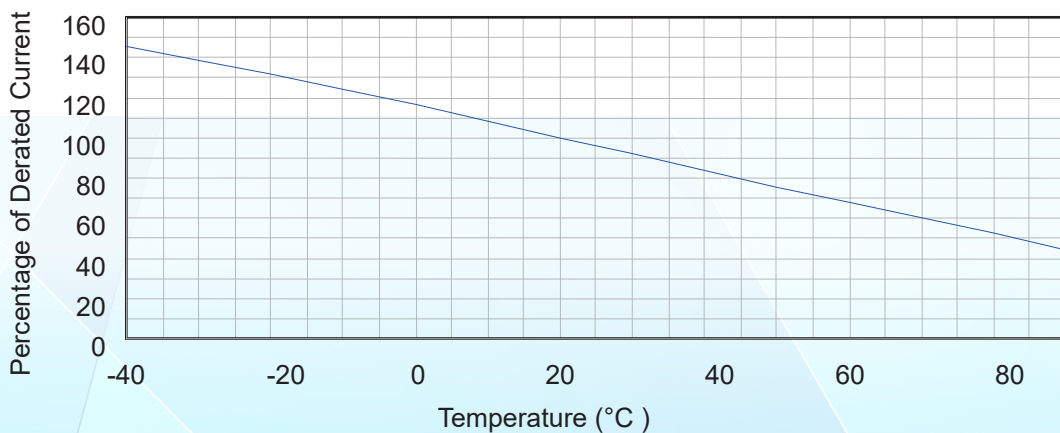

Average Time-Current Curve

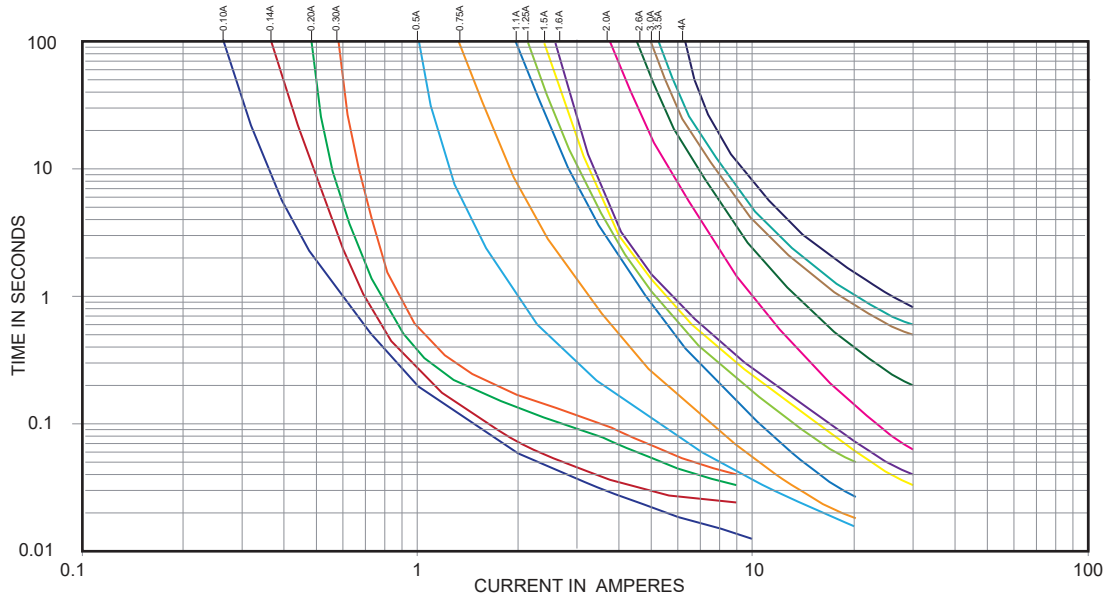

Thermal Derating Chart

Model	Maximum ambient operating temperature (T_{max}) vs. hold current (I_{hold})								
	- 40°C	- 20°C	0°C	25°C	40°C	50°C	60°C	70°C	85°C
ASMD1812-010	0.16	0.14	0.12	0.10	0.08	0.07	0.06	0.05	0.03
ASMD1812-014	0.23	0.19	0.17	0.14	0.12	0.10	0.09	0.08	0.06
ASMD1812-020	0.29	0.26	0.23	0.20	0.17	0.15	0.14	0.12	0.10
ASMD1812-030	0.44	0.39	0.35	0.30	0.26	0.23	0.21	0.18	0.15
ASMD1812-050	0.59	0.57	0.55	0.50	0.45	0.43	0.35	0.30	0.23
ASMD1812-075	1.10	0.99	0.87	0.75	0.63	0.57	0.49	0.45	0.35
ASMD1812-110	1.60	1.45	1.28	1.10	0.92	0.83	0.71	0.66	0.52
ASMD1812-125	2.00	1.75	1.52	1.25	1.00	0.95	0.90	0.75	0.53
ASMD1812-150	2.10	1.96	1.77	1.50	1.23	1.09	0.95	0.82	0.61
ASMD1812-160	2.30	2.05	1.88	1.60	1.26	1.12	0.98	0.84	0.63
ASMD1812-200	2.88	2.61	2.25	2.00	1.80	1.66	1.45	1.09	0.80
ASMD1812-260	3.90	3.42	2.96	2.60	2.33	2.07	1.94	1.35	1.00
ASMD1812-300	4.15	3.76	3.46	3.00	2.55	2.28	2.01	1.61	1.33
ASMD1812-350	4.84	4.39	4.04	3.50	2.98	2.66	2.35	1.88	1.55
ASMD1812-400	5.80	5.20	4.60	4.00	3.35	3.12	2.75	2.45	2.10

Soldering Parameters

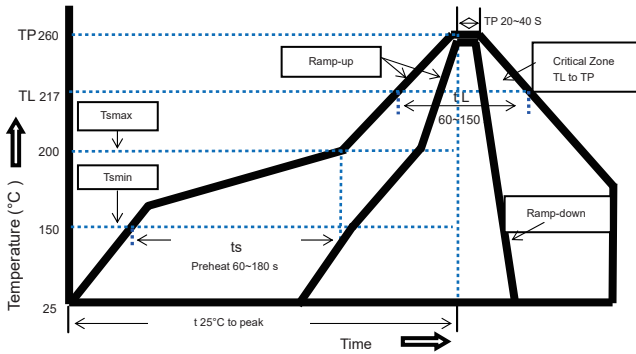

Recommended reflow methods: IR, vapor phase oven, hot air oven, N2 environment for lead-free
 Recommended maximum paste thickness is 0.25mm
 Devices can be cleaned using standard industry methods and solvents.

Note 1: All temperature refer to topside of the package, measured on the package body surface.

Note 2: If reflow temperatures exceed the recommended profile, devices may not meet the performance requirements.

Profile Feature	Pb-Free Assembly
Average Ramp-Up Rate (Ts max to T p)	3 C/second mac.
Preheat	
-Temperature Min(Ts min)	150 C
-Temperature Max(Ts max)	200 C
-Time(Ts min to Ts max)	60~180 seconds
Time maintained above:	
-Temperature(TL)	217 C
-Time(tL)	60~150 seconds
Peak Temperature(Tp)	260 C
Ramp-Down Rate	6 C/second max.
Time 25 C to Peak Temperature	8 minutes max
Storage Condition	0 C ~35 C , ≤70%RH

Physical Dimensions(mm.)

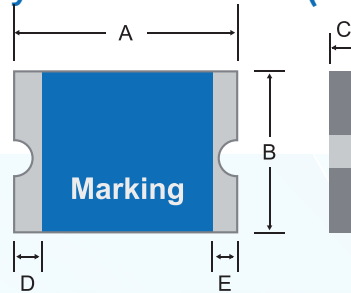

Termination Pad Characteristics

Terminal pad materials: Tin-plated Nickel-Copper

Terminal pad solder ability: Meets EIA specification RS186-9E and ANSI/J-STD-002 Category 3.

Model	A		B		C		D	E
	Min.	Max.	Min.	Max.	Min.	Max.	Min.	Min.
ASMD1812-010	4.37	4.73	3.07	3.41	0.5	1.1	0.3	0.25
ASMD1812-010-33V	4.37	4.73	3.07	3.41	0.5	1.1	0.3	0.25
ASMD1812-010-60V	4.37	4.73	3.07	3.41	0.5	1.1	0.3	0.25
ASMD1812-014	4.37	4.73	3.07	3.41	0.5	1.1	0.3	0.25
ASMD1812-014-33V	4.37	4.73	3.07	3.41	0.5	1.1	0.3	0.25
ASMD1812-020	4.37	4.73	3.07	3.41	0.5	1.1	0.3	0.25
ASMD1812-020-33V	4.37	4.73	3.07	3.41	0.5	1.1	0.3	0.25
ASMD1812-020-60V	4.37	4.73	3.07	3.41	0.5	1.1	0.3	0.25
ASMD1812-030	4.37	4.73	3.07	3.41	0.5	1.1	0.3	0.25
ASMD1812-030-33V	4.37	4.73	3.07	3.41	0.5	1.1	0.3	0.25
ASMD1812-030-60V	4.37	4.73	3.07	3.41	0.5	1.1	0.3	0.25
ASMD1812-050	4.37	4.73	3.07	3.41	0.4	1.0	0.3	0.25
ASMD1812-050-33V	4.37	4.73	3.07	3.41	0.4	1.0	0.3	0.25
ASMD1812-050-60V	4.37	4.73	3.07	3.41	0.6	1.5	0.3	0.25
ASMD1812-075	4.37	4.73	3.07	3.41	0.5	1.1	0.3	0.25
ASMD1812-075-24V	4.37	4.73	3.07	3.41	0.6	1.3	0.3	0.25
ASMD1812-075-33V	4.37	4.73	3.07	3.41	0.6	1.3	0.3	0.25
ASMD1812-110	4.37	4.73	3.07	3.41	0.4	1.0	0.3	0.25
ASMD1812-110-16V	4.37	4.73	3.07	3.41	0.4	1.0	0.3	0.25
ASMD1812-110-24V	4.37	4.73	3.07	3.41	0.6	1.3	0.3	0.25
ASMD1812-110-33V	4.37	4.73	3.07	3.41	0.6	1.3	0.3	0.25
ASMD1812-125	4.37	4.73	3.07	3.41	0.4	1.0	0.3	0.25
ASMD1812-150	4.37	4.73	3.07	3.41	0.5	1.1	0.3	0.25
ASMD1812-150-12V	4.37	4.73	3.07	3.41	0.5	1.1	0.3	0.25
ASMD1812-150-24V	4.37	4.73	3.07	3.41	0.5	1.1	0.3	0.25
ASMD1812-160	4.37	4.73	3.07	3.41	0.5	1.1	0.3	0.25
ASMD1812-200	4.37	4.73	3.07	3.41	0.5	1.1	0.3	0.25
ASMD1812-200-16V	4.37	4.73	3.07	3.41	0.5	1.1	0.3	0.25
ASMD1812-200-24V	4.37	4.73	3.07	3.41	0.5	1.5	0.3	0.25
ASMD1812-200-30V	4.37	4.73	3.07	3.41	0.5	1.5	0.3	0.25
ASMD1812-260	4.37	4.73	3.07	3.41	0.5	1.5	0.3	0.25
ASMD1812-260-16V	4.37	4.73	3.07	3.41	0.5	1.5	0.3	0.25
ASMD1812-300	4.37	4.73	3.07	3.41	0.8	1.5	0.3	0.25
ASMD1812-300-12V	4.37	4.73	3.07	3.41	0.8	1.5	0.3	0.25
ASMD1812-300-16V	4.37	4.73	3.07	3.41	0.8	1.5	0.3	0.25
ASMD1812-350	4.37	4.73	3.07	3.41	0.8	1.5	0.3	0.25
ASMD1812-350-16V	4.37	4.73	3.07	3.41	0.8	1.5	0.3	0.25
ASMD1812-400	4.37	4.73	3.07	3.41	0.8	1.5	0.3	0.25

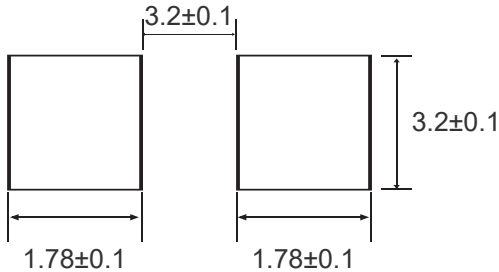
Packaging Quantity and Marking

Part Number	Quantity
ASMD1812 Series	1,500 pcs/reel
ASMD1812-350-16V	1,000 pcs/reel
ASMD1812-400	1,000 pcs/reel

Tape & reel packaging per EIA481-1

Tape And Reel Specifications (mm)

Governing Specifications	EIA 481-1
W	12 ± 0.3
P0	4.0 ± 0.10
P1	8.0 ± 0.10
P2	2.0 ± 0.05
A0	3.5 ± 0.10
B0	5.1 ± 0.10
B1max.	5.9
D0	1.50 + 0.1, -0
F	5.5 ± 0.05
E1	1.75 ± 0.10
E2min.	10.25
T	0.6
T1max.	0.1
K0	0.9 ± 0.1
Leader min.	390
Trailer min.	160
Reel Dimensions	
A max.	178
N min.	60
W1	12.4 ± 0.5
W2	18.4

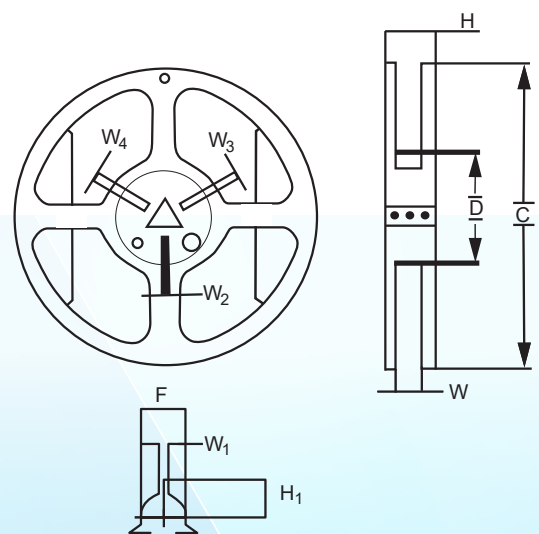
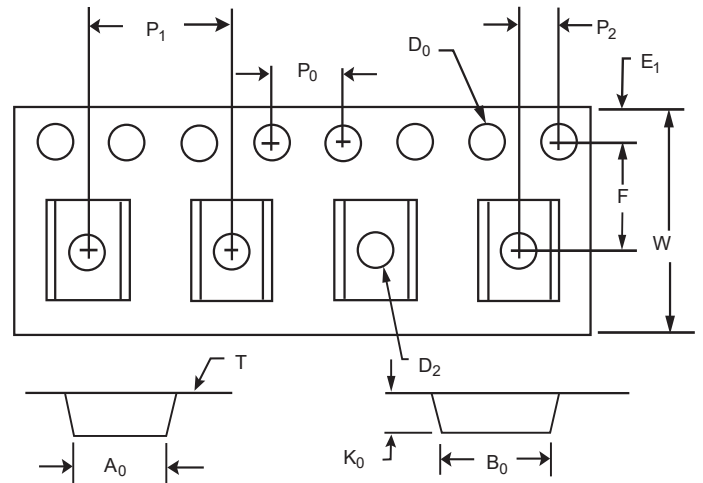
Storage And Handling

- Storage conditions: 40°C max, 70% R.H.
- Devices may not meet specified performance if storage conditions are exceeded. Technology Corp.

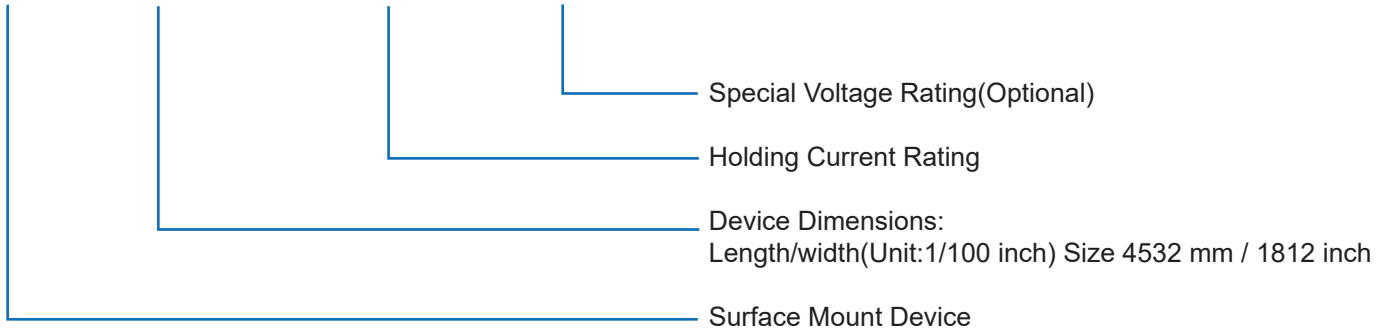
Part Number System
ASMD 1812 - □□□ - □□

Cross Reference

Model	Cross Reference		
	Tyco / PolySwitch®	Littelfuse / POLY-FUSE®	Polytronics / EVERFUSE®
ASMD1812-010	miniSMDC010F	1812L010	SMD1812P010TF
ASMD1812-014	miniSMDC014F	1812L014	SMD1812P014TF
ASMD1812-020	miniSMDC020F	1812L020	SMD1812P020TF
ASMD1812-030	-	1812L035	SMD1812P030TF
ASMD1812-050	miniSMDC050F	1812L050	SMD1812P050TF
ASMD1812-050-33V	miniSMDC050F/33V	1812L050/30	SMD1812P050TF/30
ASMD1812-050-60V	-	-	-
ASMD1812-075	miniSMDC750F	1812L075	SMD1812P075TF
ASMD1812-075-24V	miniSMDC750F/24V	1812L075/24	SMD1812P075TF/24
ASMD1812-110	miniSMDC110F	1812L110	SMD1812P110TF
ASMD1812-110-16V	miniSMDC110F/16	1812L110/16	SMD1812P110TF/16
ASMD1812-110-24V	miniSMDC110F/24	1812L110/24	SMD1812P110TF/24
ASMD1812-110-33V	miniSMDC110F/33	1812L110/33	SMD1812P110TF/33
ASMD1812-125	miniSMDC125F	1812L125	SMD1812P125TF
ASMD1812-150	miniSMDC150F	1812L150	SMD1812P150TF
ASMD1812-150-16V	miniSMDC150F/12	1812L150/12	SMD1812P150TF/12
ASMD1812-150-24V	miniSMDC150F/24	1812L150/24	SMD1812P150TF/24
ASMD1812-160	miniSMDC160F	1812L160	SMD1812P160TF
ASMD1812-200	miniSMDC200F	1812L200	SMD1812P200TF
ASMD1812-260	miniSMDC260F	1812L260	SMD1812P260TF
ASMD1812-300	miniSMDC300F	1812L300	SMD1812P300TF
ASMD1812-300-30V	miniSMDC300F/30	1812L300/30	SMD1812P300TF/30
ASMD1812-350	-	-	-
ASMD1812-400	-	-	-

"PolySwitch" is a registered trademark of Tyco Electronics.

"POLY-FUSE" is a registered trademark of Littelfuse, Inc.

"EVERFUSE" is a registered trademark of Polytronics Technology Corp.

Application Notice

1. Operation of these PPTC devices beyond the stated maximum ratings could result in damage to the devices and lead to electrical arcing and/or fire;

PPTC 器件在超过规定的最大值额定值运行可能会导致器件损坏以及导致电弧和/或火灾。

2. These PPTC devices are intended to protect against the effects of temporary over-current or over-temperature conditions and shall not be taken for use as switch.

PPTC 的作用是防止临时的过流或过温造成的不良影响，不能当作开关使用。

3. Exposure to lubricants, silicon-based oils, solvents, gels, electrolytes, acids, and other related or similar materials may adversely affect the performance of PPTC devices.

PPTC 接触润滑剂、硅基油、溶剂、凝胶、电解质、酸和其他相关或类似材料可能会对 PPTC 器件的性能有不利影响。

4. Circuits with inductance may generate a voltage above the rated voltage of the PPTC device and should be thoroughly evaluated within the user's application during the PPTC selection and qualification process.

带有电感的电路可能产生高于 PPTC 额定电压的电压，因此客户在选型和认定过程中应进行彻底的评估。

5. Please do not smash, clamp, pull, dent or twist by tool during assembling process, as they may result in the PPTC damage.

在装配过程中，避免有砸、挤、拉、扭等方式外力作用于 PPTC 本体上，因为它们可能导致 PPTC 损坏。

6. Hand-soldering of PPTC devices on boards is generally not recommended. Users shall define and verify this process if needed.

不推荐使用手工焊接的方式焊接 PPTC。如果需要，用户需要定义和验证此过程。

7. Recommended storage conditions should be followed at all times, The MSL classification of PPTC is grade 2a.

必须始终遵守推荐的保存条件要求，PPTC 的 MSL 等级为 2 a级。