

### JM RATINGS

Rating	Symbol	BC549	BC550	Unit
Collector–Emitter Voltage	$V_{CEO}$	30	45	Vdc
Collector–Base Voltage	$V_{CBO}$	30	50	Vdc
Emitter–Base Voltage	$V_{EBO}$	5.0		Vdc
Collector Current — Continuous	$I_C$	100		mAdc
Total Device Dissipation @ $T_A = 25^\circ\text{C}$ Derate above $25^\circ\text{C}$	$P_D$	625	5.0	mW mW/ $^\circ\text{C}$
Total Device Dissipation @ $T_C = 25^\circ\text{C}$ Derate above $25^\circ\text{C}$	$P_D$	1.5	12	Watt mW/ $^\circ\text{C}$
Operating and Storage Junction Temperature Range	$T_J, T_{stg}$	–55 to +150		$^\circ\text{C}$

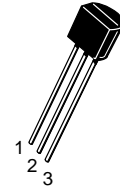

CASE 29–04, STYLE 17  
TO–92 (TO–226AA)

### THERMAL CHARACTERISTICS

Characteristic	Symbol	Max	Unit
Thermal Resistance, Junction to Ambient	$R_{\theta JA}$	200	$^\circ\text{C}/\text{W}$
Thermal Resistance, Junction to Case	$R_{\theta JC}$	83.3	$^\circ\text{C}/\text{W}$

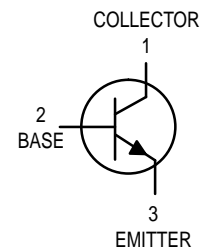

### ELECTRICAL CHARACTERISTICS ( $T_A = 25^\circ\text{C}$ unless otherwise noted)

Characteristic	Symbol	Min	Typ	Max	Unit
----------------	--------	-----	-----	-----	------

### OFF CHARACTERISTICS

Collector–Emitter Breakdown Voltage ( $I_C = 10 \text{ mAdc}, I_B = 0$ )	BC549B,C BC550B,C	$V_{(BR)CEO}$	30 45	— —	— —	Vdc
Collector–Base Breakdown Voltage ( $I_C = 10 \mu\text{Adc}, I_E = 0$ )	BC549B,C BC550B,C	$V_{(BR)CBO}$	30 50	— —	— —	Vdc
Emitter–Base Breakdown Voltage ( $I_E = 10 \mu\text{Adc}, I_C = 0$ )		$V_{(BR)EBO}$	5.0	—	—	Vdc
Collector Cutoff Current ( $V_{CB} = 30 \text{ V}, I_E = 0$ ) ( $V_{CB} = 30 \text{ V}, I_E = 0, T_A = +125^\circ\text{C}$ )		$I_{CBO}$	— —	— —	15 5.0	nAdc $\mu\text{Adc}$
Emitter Cutoff Current ( $V_{EB} = 4.0 \text{ Vdc}, I_C = 0$ )		$I_{EBO}$	—	—	15	nAdc

**ELECTRICAL CHARACTERISTICS** ( $T_A = 25^\circ\text{C}$  unless otherwise noted) (Continued)

Characteristic	Symbol	Min	Typ	Max	Unit
<b>ON CHARACTERISTICS</b>					
DC Current Gain ( $I_C = 10 \mu\text{A}$ , $V_{CE} = 5.0 \text{ Vdc}$ )  ( $I_C = 2.0 \text{ mA}$ , $V_{CE} = 5.0 \text{ Vdc}$ )	$h_{FE}$	100 100 200 420	150 270 290 500	— — 450 800	—
Collector–Emitter Saturation Voltage ( $I_C = 10 \text{ mA}$ , $I_B = 0.5 \text{ mA}$ ) ( $I_C = 10 \text{ mA}$ , $I_B = \text{see note 1}$ ) ( $I_C = 100 \text{ mA}$ , $I_B = 5.0 \text{ mA}$ , see note 2)	$V_{CE(sat)}$	— — —	0.075 0.3 0.25	0.25 0.6 0.6	Vdc
Base–Emitter Saturation Voltage ( $I_C = 100 \text{ mA}$ , $I_B = 5.0 \text{ mA}$ )	$V_{BE(sat)}$	—	1.1	—	Vdc
Base–Emitter On Voltage ( $I_C = 10 \mu\text{A}$ , $V_{CE} = 5.0 \text{ Vdc}$ ) ( $I_C = 100 \mu\text{A}$ , $V_{CE} = 5.0 \text{ Vdc}$ ) ( $I_C = 2.0 \text{ mA}$ , $V_{CE} = 5.0 \text{ Vdc}$ )	$V_{BE(on)}$	— — 0.55	0.52 0.55 0.62	— — 0.7	Vdc

**SMALL–SIGNAL CHARACTERISTICS**

Current–Gain — Bandwidth Product ( $I_C = 10 \text{ mA}$ , $V_{CE} = 5.0 \text{ Vdc}$ , $f = 100 \text{ MHz}$ )	$f_T$	—	250	—	MHz
Collector–Base Capacitance ( $V_{CB} = 10 \text{ Vdc}$ , $I_E = 0$ , $f = 1.0 \text{ MHz}$ )	$C_{cbo}$	—	2.5	—	pF
Small–Signal Current Gain ( $I_C = 2.0 \text{ mA}$ , $V_{CE} = 5.0 \text{ V}$ , $f = 1.0 \text{ kHz}$ )	$h_{fe}$	240 450	330 600	500 900	—
Noise Figure ( $I_C = 200 \mu\text{A}$ , $V_{CE} = 5.0 \text{ Vdc}$ , $R_S = 2.0 \text{ k}\Omega$ , $f = 1.0 \text{ kHz}$ ) ( $I_C = 200 \mu\text{A}$ , $V_{CE} = 5.0 \text{ Vdc}$ , $R_S = 100 \text{ k}\Omega$ , $f = 1.0 \text{ kHz}$ )	$NF_1$ $NF_2$	— —	0.6 —	2.5 10	dB

NOTES:

- $I_B$  is value for which  $I_C = 11 \text{ mA}$  at  $V_{CE} = 1.0 \text{ V}$ .
- Pulse test =  $300 \mu\text{s}$  – Duty cycle = 2%.

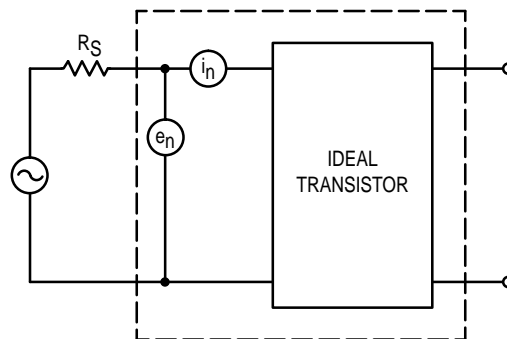
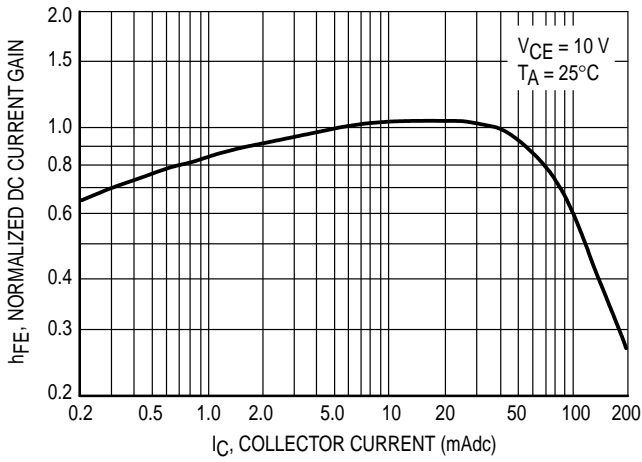
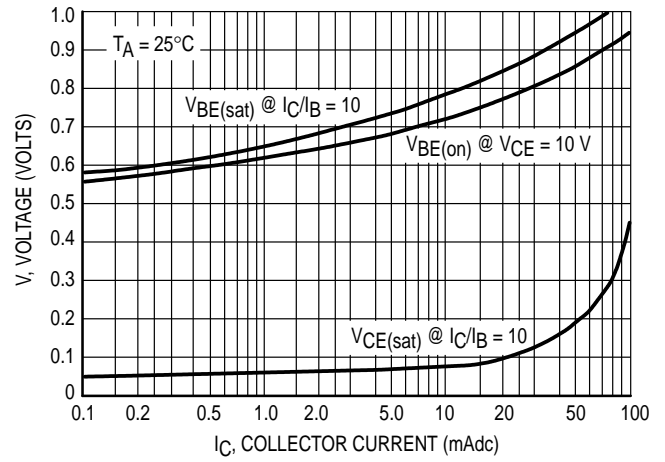
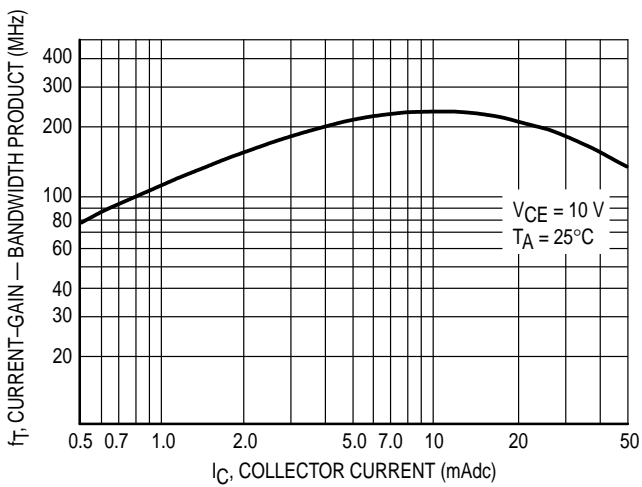
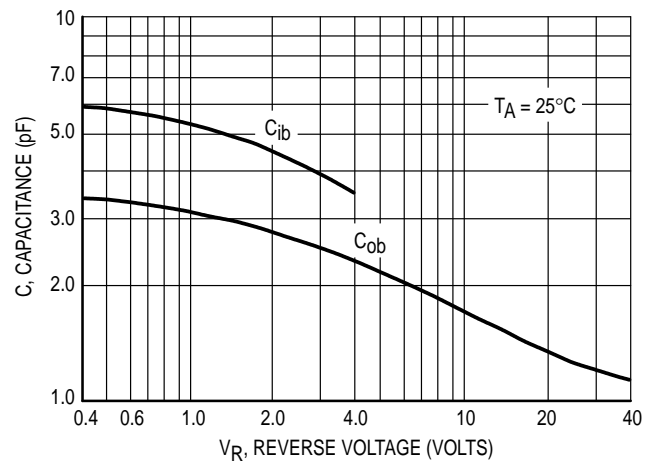
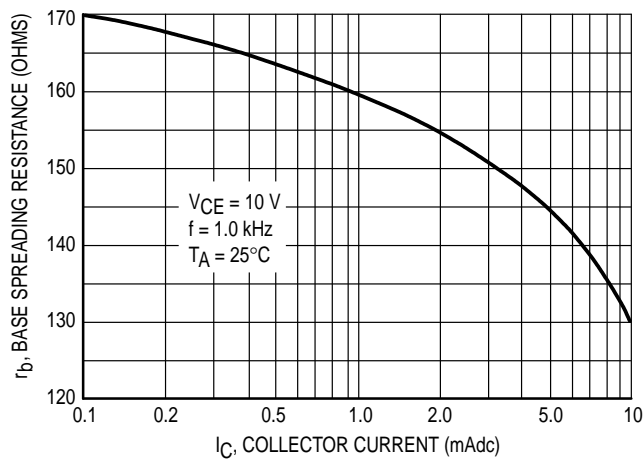
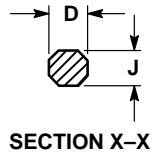
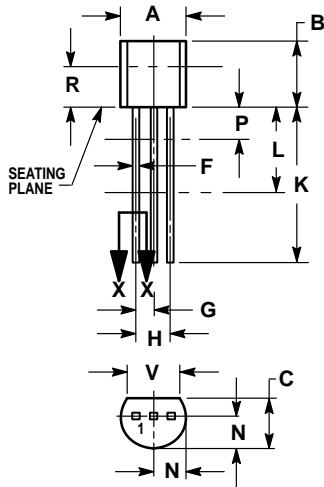

Figure 1. Transistor Noise Model

**Figure 2. Normalized DC Current Gain**

**Figure 3. "Saturation" and "On" Voltages**

**Figure 4. Current-Gain — Bandwidth Product**

**Figure 5. Capacitance**

**Figure 6. Base Spreading Resistance**

**PACKAGE DIMENSIONS**

**NOTES:**

1. DIMENSIONING AND TOLERANCING PER ANSI Y14.5M, 1982.
2. CONTROLLING DIMENSION: INCH.
3. CONTOUR OF PACKAGE BEYOND DIMENSION R IS UNCONTROLLED.
4. DIMENSION F APPLIES BETWEEN P AND L. DIMENSION D AND J APPLY BETWEEN L AND K. MINIMUM. LEAD DIMENSION IS UNCONTROLLED IN P AND BEYOND DIMENSION K MINIMUM.

DIM	INCHES		MILLIMETERS	
	MIN	MAX	MIN	MAX
A	0.175	0.205	4.45	5.20
B	0.170	0.210	4.32	5.33
C	0.125	0.165	3.18	4.19
D	0.016	0.022	0.41	0.55
F	0.016	0.019	0.41	0.48
G	0.045	0.055	1.15	1.39
H	0.095	0.105	2.42	2.66
J	0.015	0.020	0.39	0.50
K	0.500	—	12.70	—
L	0.250	—	6.35	—
N	0.080	0.105	2.04	2.66
P	—	0.100	—	2.54
R	0.115	—	2.93	—
V	0.135	—	3.43	—

**CASE 029-04  
(TO-226AA)  
ISSUE AD**

**STYLE 17:**

- PIN 1. COLLECTOR
2. BASE
3. EMITTER