

## Features

- ◆ Ultra small package: 1.0x0.6x0.5mm
- ◆ Ultra low capacitance: 15pF typical
- ◆ Ultra low leakage: nA level
- ◆ Low operating voltage: 5V
- ◆ Low clamping voltage
- ◆ 2-pin leadless package
- ◆ Complies with following standards:
  - IEC 61000-4-2 (ESD) immunity test
    - Air discharge:  $\pm 30\text{kV}$
    - Contact discharge:  $\pm 30\text{kV}$
  - IEC61000-4-5 (Lightning) 6A (8/20 $\mu\text{s}$ )
- ◆ RoHS Compliant

## Description

The ESDJ5B0U4D2 is a bi-directional TVS diode, utilizing leading monolithic silicon technology to provide fast response time and low ESD clamping voltage, making this device an ideal solution for protecting voltage sensitive data and power line. The ESDJ5B0U4D2 complies with the IEC 61000-4-2 (ESD) standard with  $\pm 30\text{ kV}$  air and  $\pm 30\text{kV}$  contact discharge. It is assembled into an ultra-small 1.0x0.6x0.5mm lead-free 0402 package. The small size and high ESD surge protection make ESDJ5B0U4D2 an ideal choice to protect cell phone, digital cameras, audio players and many other portable applications.

## Circuit Diagram

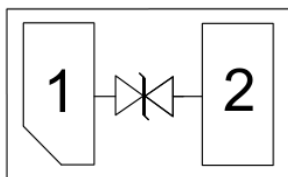

## Applications

- ◆ Cellular Handsets and Accessories
- ◆ Personal Digital Assistants
- ◆ Notebooks and Handhelds
- ◆ Portable Instrumentation
- ◆ Digital Cameras
- ◆ Peripherals
- ◆ Audio Players
- ◆ Keypads, Side Keys, LCD Displays

**Absolute Maximum Ratings :** ( $T_c=25^{\circ}\text{C}$  unless otherwise noted)

Parameter	Symbol	Value	Unit
Peak Pulse Power (8/20 $\mu\text{s}$ )	Ppk	72	W
Peak Pulse Current (8/20 $\mu\text{s}$ )	IPP	6	A
ESD per IEC 61000-4-2 (Air)	VESD	$\pm 30$	kV
ESD per IEC 61000-4-2 (Contact)		$\pm 30$	
Operating Temperature Range	TJ	-55 to +125	$^{\circ}\text{C}$
Storage Temperature Range	Tstg	-55 to +150	$^{\circ}\text{C}$

**Electrical Characteristics :** ( $T_c=25^{\circ}\text{C}$  unless otherwise noted)

Parameter	Symbol	Test Condition	Min	Typ	Max	Unit
Reverse Working Voltage	$V_{RWM}$				5.0	V
Breakdown Voltage	$V_{BR}$	$I_T = 1\text{mA}$	5.6	7.5	8.5	V
Reverse Leakage Current	$I_R$	$V_{RWM} = 5.0\text{V}$			0.1	$\mu\text{A}$
Clamping Voltage	$V_C$	$I_{PP} = 1\text{A}$ (8 / 20 $\mu\text{s}$ pulse)			9.0	V
Clamping Voltage	$V_C$	$I_{PP} = 6\text{A}$ (8 / 20 $\mu\text{s}$ pulse)			12.0	V
Junction Capacitance	$C_J$	$V_R = 0\text{V}$ , $f = 1\text{MHz}$		15	22	pF

**Portion Electronics Parameter**

Symbol	Parameter
$V_{RWM}$	Peak Reverse Working Voltage
$I_R$	Reverse Leakage Current @ $V_{RWM}$
$V_{BR}$	Breakdown Voltage @ $I_T$
$I_T$	Test Current
$I_{PP}$	Maximum Reverse Peak Pulse Current
$V_C$	Clamping Voltage @ $I_{PP}$

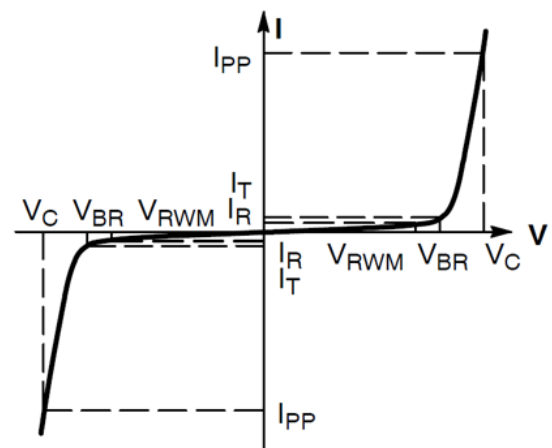

**Bi-Directional TVS**

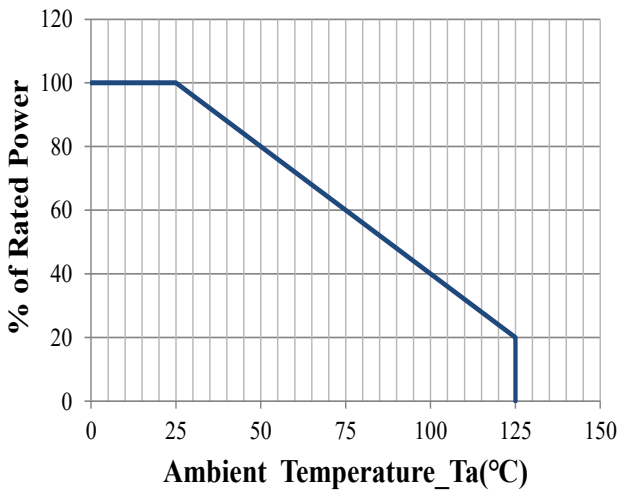
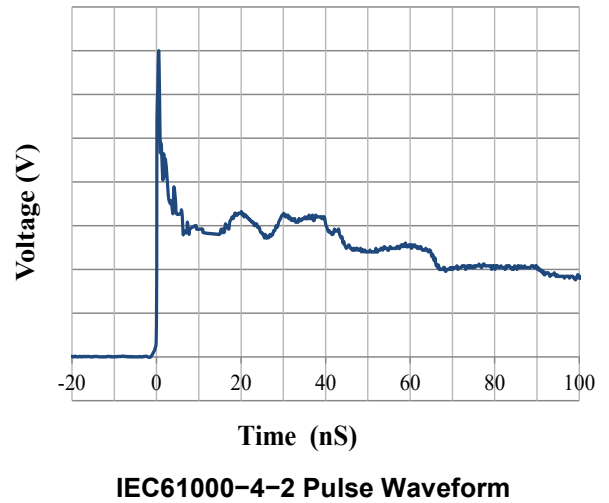
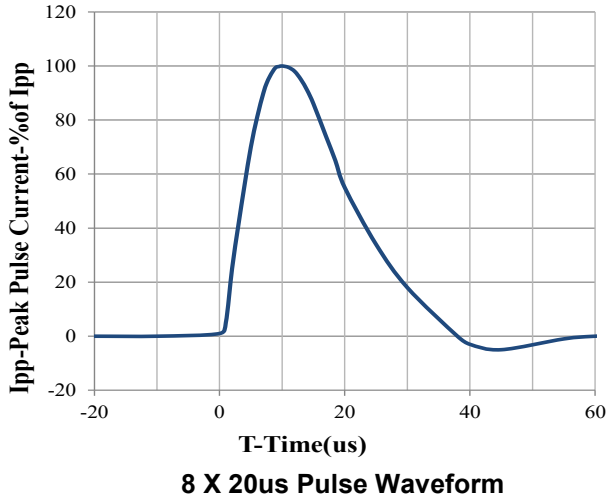
Typical Characteristics: ( $T_c=25^\circ\text{C}$  unless otherwise noted)

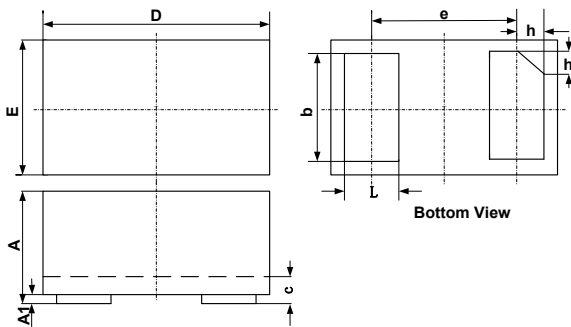

## Package Dimension

### DFN1006-2(0402) Package Outline



SYM	DIMENSIONS					
	MILLIMETERS			INCHES		
	MIN	NOM	MAX	MIN	NOM	MAX
A	0.45	0.50	0.55	0.018	0.020	0.022
A1	0.00	0.02	0.05	0.000	0.001	0.002
b	0.45	0.50	0.55	0.018	0.020	0.022
c	0.12	0.15	0.18	0.005	0.006	0.007
D	0.95	1.00	1.05	0.037	0.039	0.041
e	0.65 BSC			0.026 BSC		
E	0.55	0.60	0.65	0.022	0.024	0.026
L	0.20	0.25	0.30	0.008	0.010	0.012
h	0.07	0.12	0.17	0.003	0.005	0.007

## Suggested Land Pattern

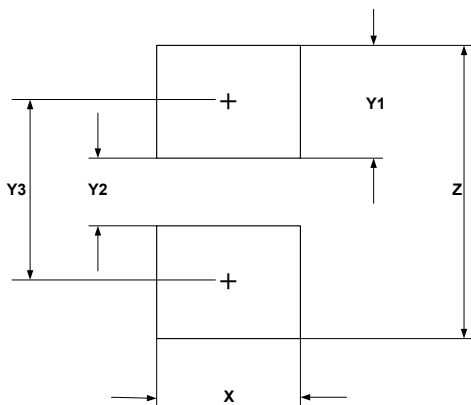

SYM	DIMENSIONS	
	MILLIMETERS	INCHES
X	0.60	0.024
Y1	0.50	0.020
Y2	0.30	0.012
Y3	0.80	0.032
Z	1.30	0.052

### Soldering Parameters

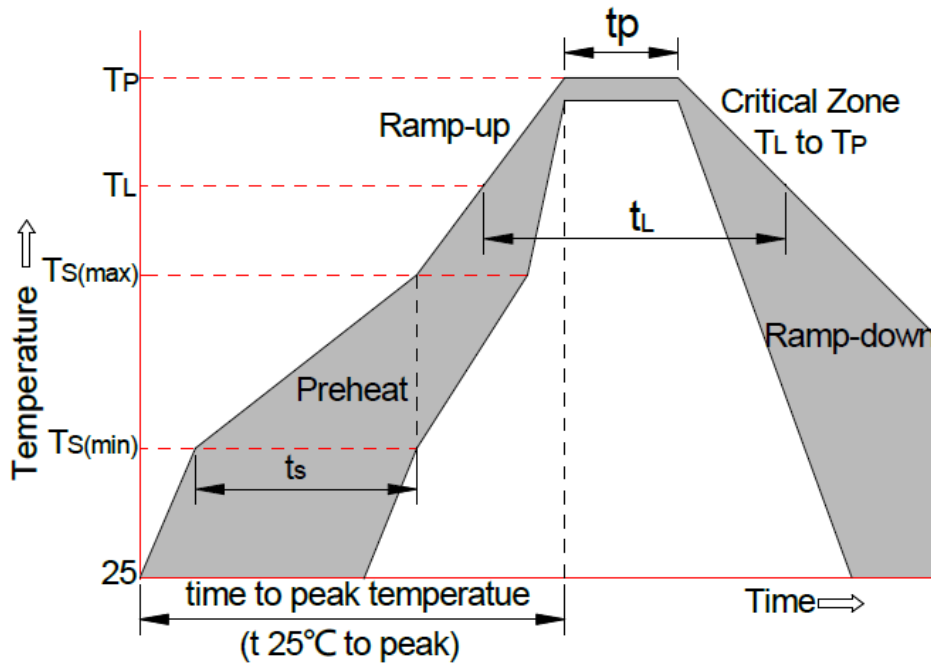

Reflow Condition		Pb-Free Assembly
Pre-heat	-Temperature Min (Ts (min))	+150°C
	-Temperature Max (Ts (max))	+200°C
	-Time (Min to Max) (ts)	60-180 secs
Average ramp up rate( Liquid us Temp (TL) to peak)		3°C/sec. Max
Ts (max) to TL-Ramp-up Rate		3°C/sec. Max
Reflow	-Temperature (TL) (Liquid us)	+217°C
	-Temperature (tL)	60-150 secs
Peak Temp (Tp)		+260(+0/-5)°C
Time within 5°C of actual Peak Temp (tp)		30 secs. Max
Ramp-down Rate		6 °C/secs. Max
xTime 25°C to Peak Temp (Tp)		8 min. Max
Do not exceed		+260°C