

目錄 MAPX	設變內容 MODIFICATION	日期 DATE

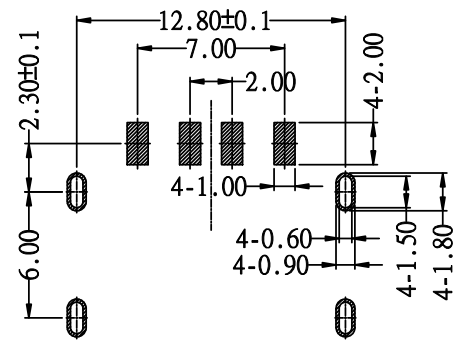

RECOMMENDED P.C.B LAYOUT

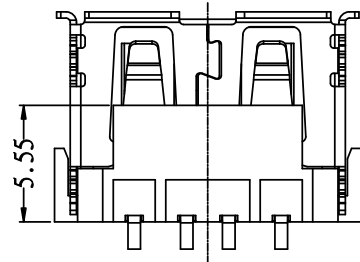
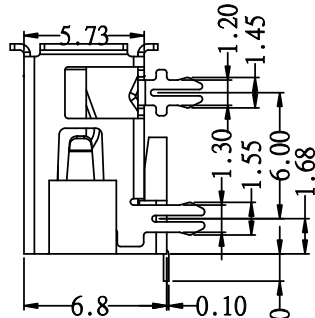
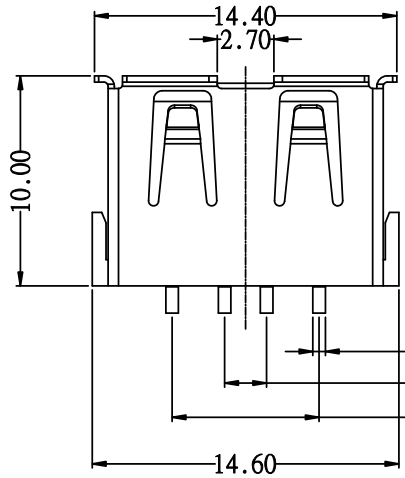
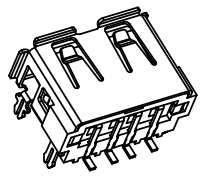
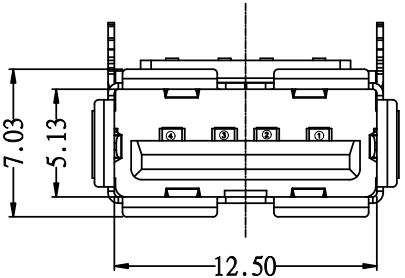
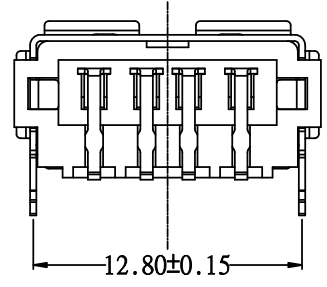

电气特性:Electrical:

1. 额定电流: Current Rating
1.5A/contact terminal
2. 额定电压: Voltage Rating
30V DC
3. 接触阻抗: Contact Resistance
30 milliohms MAX
4. 耐电压: Dielectric Withstanding Voltage:
500 V AC AT Sea Level
5. 绝缘阻抗: Insulation Resistance:
1000MEGA ohms MIN

物理性能: Mechanical:

1. 插拔力: Connector Mate and Unmate Force
Mate force: 3.57kgf (MAX)
Unmate force: 1.02kgf (MIN)
2. 端子保持力: Terminal Retention
1.2kgf (MIN)
3. 寿命: 1500次

原材料: Material:

1. 塑胶: Housing: LCP BK
2. 端子: Contact: Copper Alloy C2680
3. 外壳: Shell: SPCC

电镀: Finish:

1. 端子 Contact: Au 0.7u" Plated on contact area
Tin50u" Plated on solder area
Nickel 50u" Plated underplating over all.
2. 外壳 Shell: Nickel 50u" Min plating over all.

深圳市精拓金电子有限公司

产品图 PRODUCT CHART DWG		单位 UNITS		MM	制图 DRAWING	林属升	产品料号 PRODUCT PART NO.	908-371A2022S10100	
公差一览表 TOLERANCE UNLESS OTHERWISE		比例 SCALE		1:1	审核 CHKD	郭志富	产品名称 PRODUCT NO.		AF10.0A款四脚有边有缺口铁壳 LCP黑胶6.8SMT
Pin NUMBER	SIGNAL NAME	.X	±0.25	.X'	±5'	日期 DATE	2015/10/20	核准 APPD	黄国荣
1	VBUS	.XX	±0.15	.XX'	±1'	角法 VIEW	⊕	版本 VER	A0
2	D-	.XXX	±0.10	.XXX'	±0.5'				
3	D+								
4	GND								