

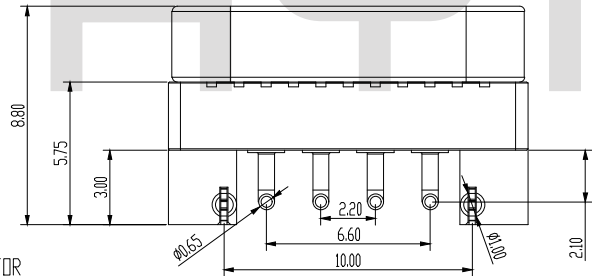

<https://www.hyte.pro/product/m411p.html>

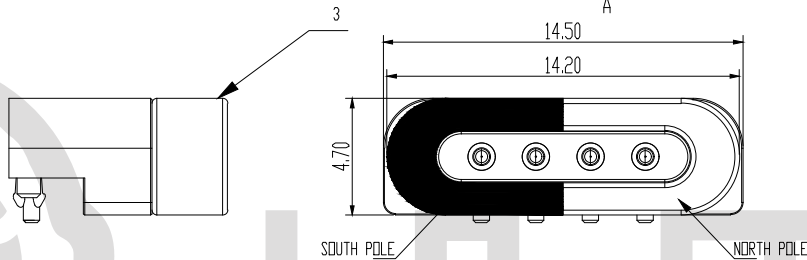
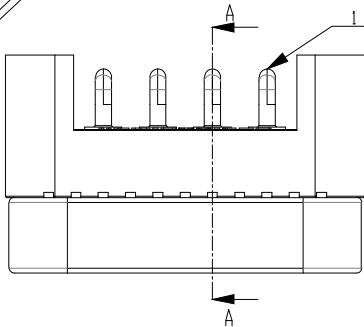
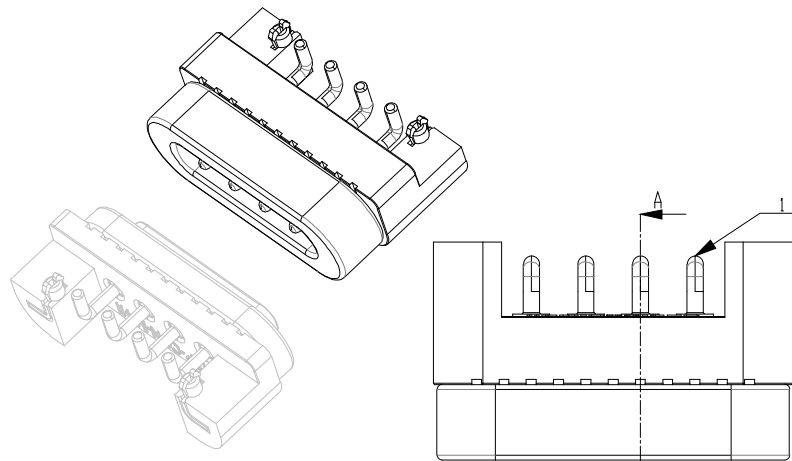

- NOTE:
- THE HEIGHT OF POGO PINS MUST BE 100% CHECKED;
 - AFTER ASSEMBLING, THE PROBE REBOUNDS WELL AFTER BEING PRESSED 5 TIMES, WITHOUT ANY HIGH OR LOW PHENOMENDN.
 - DO THE ADSORPTION TEST AFTER THE MAGNET IS GLUED FOR 24 HOURS.
 - RATED CURRENT : 2A
 - SPRING : STAINLESS STEEL SUS304/SWP
 - NEEDLE : BRASS C2700 / C3604

BOM:

ITEM	NAME	MATERIAL	SURFACE	QT'Y
4	CLIP	STAINLESS STEEL	NICKEL PLATED	2 PCS
3	MAGNET	NDFEB	NICKEL PLATED	1 PCS
2	HOUSING	PBT	BLACK	1 PCS
1	POGO PIN	BRASS	GOLD PLATED 5U''	4 PCS

REV.	MODIFICATION	ECN NO.	NAME	DATE
A/0	NEW SPECIFICATIONS	2016090101	WINNIE	09/01
A/1	ADD PART NUMBER IDENTIFICATION AND DISPENSING GROOVE	2019052701	WINNIE	05/27

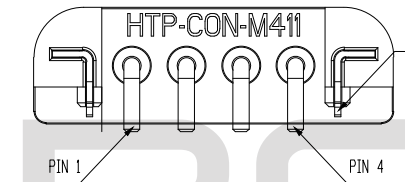
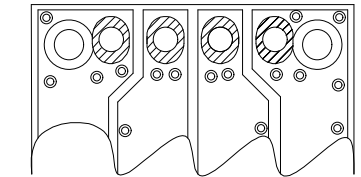
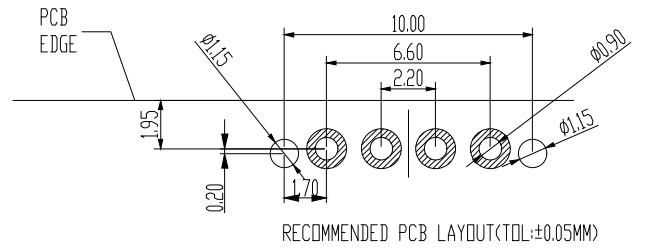

PIN ASSIGNMENT			
PIN	SIGNAL	DESCRIPTION	COLOR
1	VCC	+5V DC	RED
2	D-	DATA -	WHITE
3	D+	DATA +	GREEN
4	GND	GROUND	BLACK

REV:	A/1	SCALE:	FIT
UNIT:	MM	SHEET:	1 OF 1

HYTEPRO TECHNOLOGIES LIMITED



GENERAL TOLERANCES	
X. ±0.30	X*. ±2°
.X ±0.20	.X* ±0.5°
.XX ±0.10	.XX* ±0.3°

THIRD ANGLE

产品名称 PRODUCT NAME		4 PINS MAGNETIC CONNECTOR MALE	
缩水率 SHRINKAGE		零件名称 PART NAME	
材质 MATERIAL		料号 PART NO.	HTP-CON-M411P
表面 SURFACE		模号 MOLD NO.	HTP-CON-M411PR-M

核准 APPROVED BY		JAMES	
审核 CHECKED BY		制表 DRAWN BY	WINNIE
日期 DATE		日期 DATE	2016/09/01



<https://www.hyte.pro/product/m411p.html>

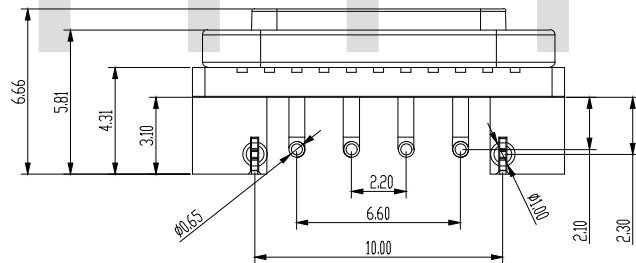
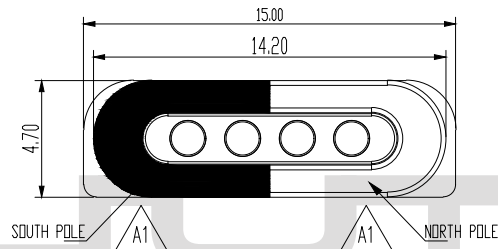
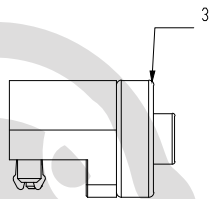
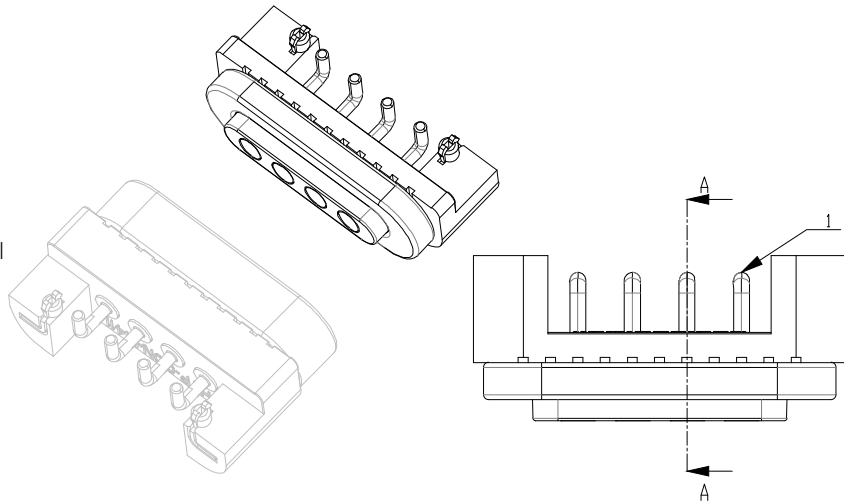

REV.	MODIFICATION	ECN NO.	NAME	DATE
A/0	NEW SPECIFICATIONS	2016090101	WINNIE	09/01
A/1	ADD PART NUMBER IDENTIFICATION AND DISPENSING GROOVE	2019052701	WINNIE	05/27

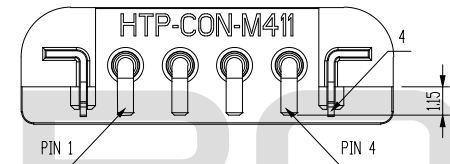
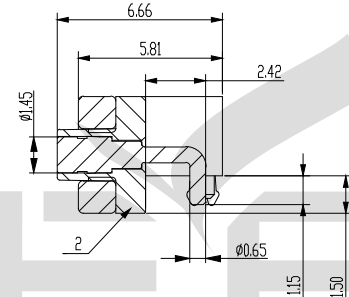
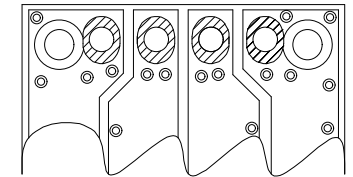
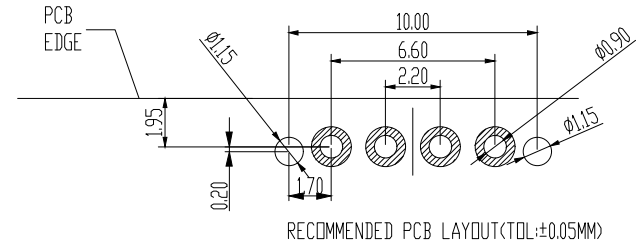

PIN ASSIGNMENT			
PIN	SIGNAL	DESCRIPTION	COLOR
4	VCC	+5V DC	RED
3	D-	DATA -	WHITE
2	D+	DATA +	GREEN
1	GND	GROUND	BLACK

NOTE:
- DO THE ADSORPTION TEST AFTER THE MAGNET IS GLUED FOR 24 HOURS.

REV:	A/1	SCALE:	FIT
UNIT:	MM	SHEET:	1 OF 1

HYTEPRO TECHNOLOGIES LIMITED

HYTEPRO
[HTTPS://WWW.HYTE.PRO](https://www.hyte.pro)

GENERAL TOLERANCES		产品名称 PRODUCT NAME		POSITIVE 4 PINS MAGNETIC CONNECTOR FEMALE		核准 APPROVED BY		JAMES	
X.	±0.30	X*	±2°	缩水率 SHRINKAGE	/	零件名称 PART NAME	/	审核 CHECKED BY	BRUCE
X	±0.20	X*	±0.5°	材质 MATERIAL	/	料号 PART NO.	HTP-CON-M411P	制表 DRAWN BY	WINNIE
.XX	±0.10	.XX*	±0.3°	表面 SURFACE	/	模号 MOLD NO.	HTP-CON-M411P-F	日期 DATE	2016/09/01
THIRD ANGLE									

BOM:

ITEM	NAME	MATERIAL	SURFACE	QT'Y
4	CLIP	STAINLESS STEEL	NICKEL PLATED	2 PCS
3	MAGNET	NDFEB	NICKEL PLATED	1 PCS
2	HOUSING	PBT	BLACK	1 PCS
1	SOLDER PIN	BRASS	GOLD PLATED 5U"	4 PCS