

RoHS

Specification

规格书

Client Name :

客户名称 : _____

Client P/N :

客户品号 : _____

Product P/N :
HL-C3535F10V405-D1-LVR9(Au120)

产品型号 : _____

Sending Date:

送样日期 : _____

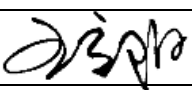
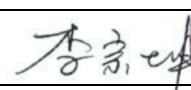
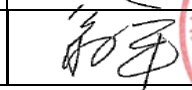
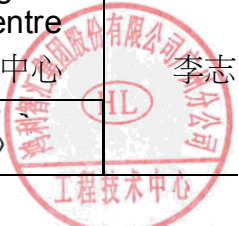
Client approval 客户审核		HongliZhihui approval 鸿利智汇审核			
Approval 核准	Audit 确认	Audit 确认			Confirmation 制作
		Sales department 营销中心	Quality department 品质部	Engineering technology centre 工程技术中心	李志强
					
<input type="checkbox"/> Qualified 接受 <input type="checkbox"/> Disqualified 不接受		DATE: 日期: _____			

Adr : No. 1, Xianke Yi Road, Huadong Town, Huadu District, Guangzhou, China

地址 : 中国广州市花都区花东镇先科一路1号

Tel/电话 : 020-86733333

Fax/传真 : 020-86733883 86733938 86733265

Web/网址 : www.honglitronic.com

注: 1. 此规格书以中英文方式书写,若有冲突以中文版本为准文本.

2. 此规格书的最终解释权归鸿利智汇集团股份有限公司

3. 此规格书的有效期限为两年,自盖章或签字之日起计算,期满时双方可以续签协议,但应采用书面形式

Catalog目录

1. Product naming rules

产品命名规则 ······ 3

2. Features

特点 ······ 3

3. Application range

应用范围 ······ 3

4. Specifications

规格 ······ 4

5. Product bins

产品分级 ······ 5

6. Typical Optical/Electrical Characteristics Curves

典型光学/电性特征曲线 ······ 6

7. Package Dimensions

封装尺寸 ······ 7

8. Welded plate and steel mesh Dimensions

焊盘及钢网尺寸 ······ 7

9. Tape Specifications

包装规格 ······ 8

10. Reflow soldering instructions

回流焊说明 ······ 9

11. Reliability Test

可靠性测试 ······ 10

12. Use the matters needing attention

使用注意事项 ······ 11-13

Product naming rules 产品命名规则

HL-C 3535 F10 V 405- D 1 LVR9 (Au 120)
1 2 3 4 5 6 7 8 9 10 11

- 1 : HongLi code 鸿利光电代码
- 2 : Product family code 产品系列代码
- 3 : Size 尺寸代码
- 4 : Chip code 芯片代码
- 5 : The color of the light 表示发光颜色
- 6 : Product wavelength 400~410nm
产品波长400~410nm
- 7 : Chip circuit 表示晶片线路
- 8 : Number of chips 芯片数量
- 9 : Zener code 表示齐纳代码
- 10 : Coating process 基板镀层工艺
- 11 : Radiation Angle 辐射角度120°

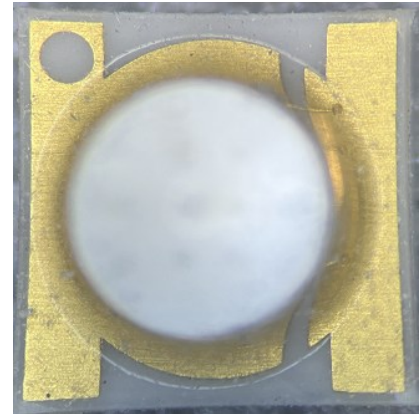

ATTENTION
OBSERVE PRECAUTIONS
FOR HANDLING
ELECTROSTATIC
DISCHARGE
SENSITIVE
DEVICES

Features 特点

- Near ultraviolet LED 近紫外LED
- Size 外形尺寸: 3.45mm*3.45mm*2.0mm
- SMT solderable SMT焊接
- Low thermal resistance 低热阻
- EDS Electrostatic Protection ESD静电防护
- RoHS compliant 符合RoHS标准

Application range 应用范围

- UV-cure UV固化
- UV Printing UV印刷
- UV Exposure UV曝光
- Counterfeit Detection/ Security 伪造品检测/安全
- Air Purification 空气净化

Specifications规格

(1)Optical Characteristics at Ta=25°C

在Ta=25°C 时典型光学特性

Symbol 符号	Item名称	Min. 最低	Typ. 典型	Max. 最大	Units 单位	Test Conditions 测试条件
Φe	Radiation Flux 辐射功率	1400	—	1800	mW	IF=1000mA
VF	Forward Voltage 正向电压	3.2	—	4.2	V	IF=1000mA
λP	Peak Wavelength 峰值波长	400	405	410	nm	IF=1000mA
2θ1/2	50% Radiation Angle 辐射角度	—	120	—	deg	IF=1000mA
R th	thermal resistance 热阻	—	—	10	°C/W	IF=1000mA
Δλ	Spectrum Half Width 半波宽	—	16.5	—	nm	IF=1000mA

(2)Absolute Maximum Ratings at Ta=25°C

在Ta=25°C时绝对极限条件

Parameter参数	Symbol符号	Rating 值	Units单位
Power dissipation 功率	Pd	4.8	W
Peak Forward Current 正向电流	IFP	1200	mA
Junction Temperature 结温	Tj	115	°C
Operating Temperature Range 工作温度	Topr	-20°C To +60°C	
Storage Temperature Range 储藏温度	Tstg	-40°C To +100°C	

Notes: 备注

- The above forward voltage measurement allowance tolerance is ±3%. 以上所示电压测量误差±3%。
- The above peak wavelength measurement allowance tolerance is ±3nm. 以上所示峰值波长测量误差±3nm。
- The above total radiant flux measurement allowance tolerance ±10%. 上述辐射功率的测试公差为±10%。
- Care is to be taken that power dissipation does not exceed the absolute maximum rating of the product.
使用功率不能超过规定的最大值。
- All measurements were made under the standardized environment.所有的测试都是基于现有的标准测试平台。
- When the LEDs are in operation the maximum current should be decided after measuring the package temperature, junction temperature should not exceed the maximum rate.
LED使用的最大电流需要根据散热条件确定，结温不能超过最大值。

Product bins 产品分级

(IF=1000mA, Ta=25°C, RH=40%)

(1) Forward Voltage bins

电压分级

BIN	Min (V)	Max (V)
V32	3.2	3.4
V34	3.4	3.6
V36	3.6	3.8
V38	3.8	4.0
V40	4.0	4.2

(2) Peak wavelength bins

峰值波长分级

BIN	Min (nm)	Max (nm)
P40-1	400	405
P40-2	405	410

(3) Radiant Flux bins

辐射通量分级

BIN	Min (mw)	Max (mw)
N140	1400	1600
N160	1600	1800

Notes :

1. Peak Wavelength Measurement tolerance : $\pm 3\text{nm}$. 以上所示峰值波长测量误差 $\pm 3\text{nm}$ 。
2. Radiant Flux Measurement tolerance : $\pm 10\%$. 以上辐射功率的测试公差为 $\pm 10\%$ 。
3. Forward Voltage Measurement tolerance : $\pm 3\%$. 以上所示电压测量误差 $\pm 3\%$ 。

Typical Optical/Electrical Characteristics Curves ($T_a=25^\circ\text{C}$)

典型光学/电性特征曲线 ($T_a=25^\circ\text{C}$)

Fig.1- 相对光谱功率分布图

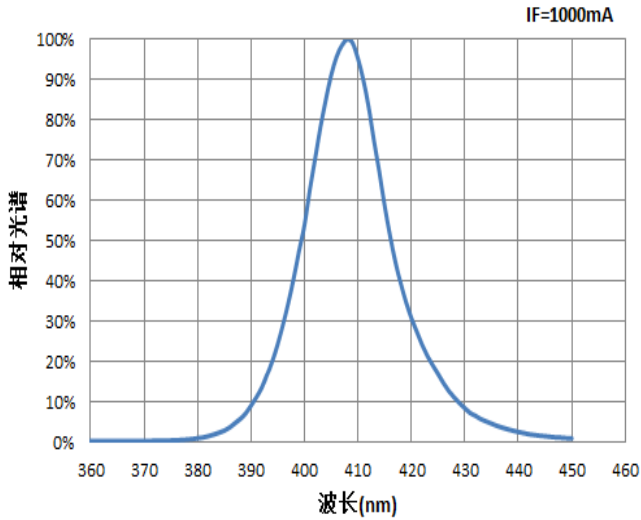

Fig.2- 伏安特性曲线

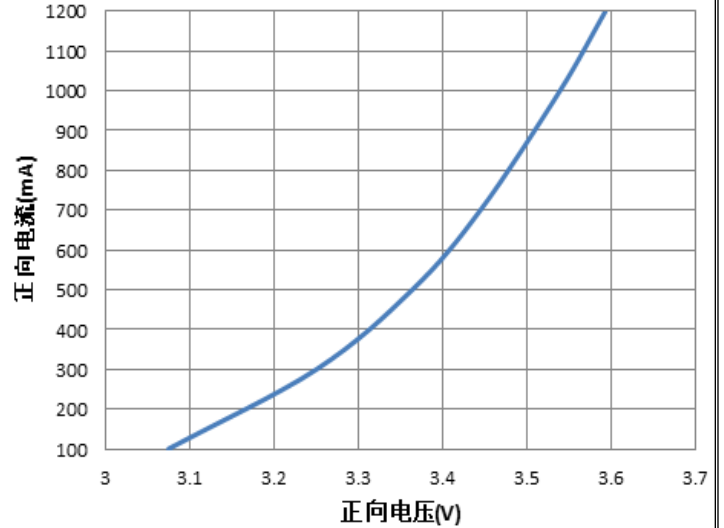

Fig.3- 相对辐射通量与正向电流图

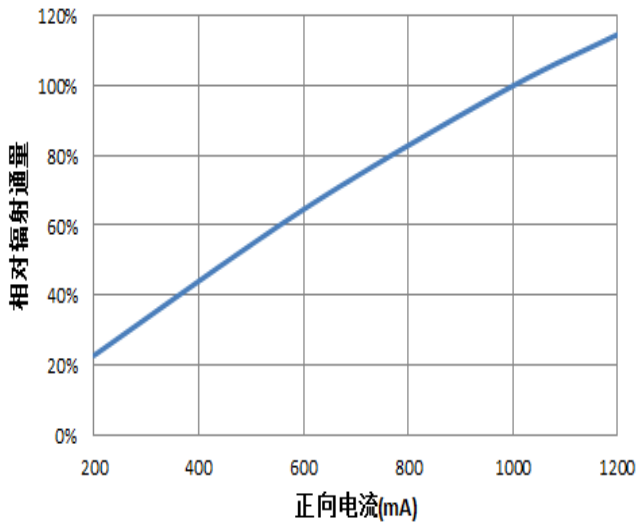

Fig.4- 峰值波长与正向电流图

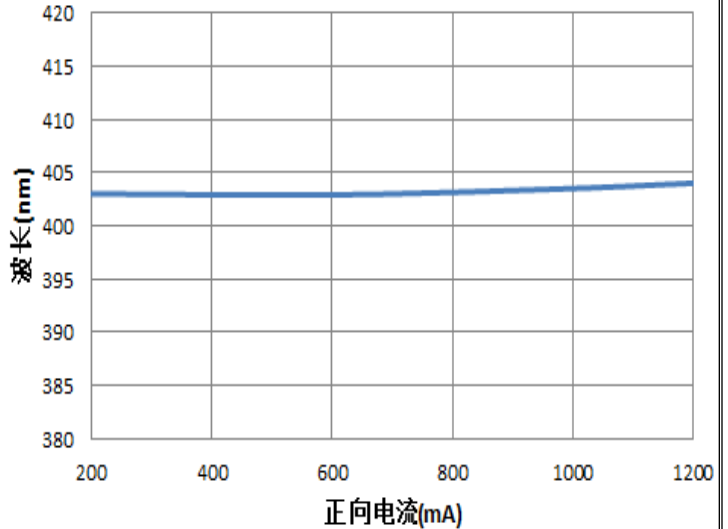
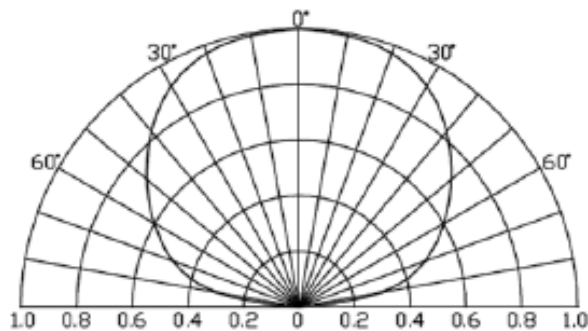
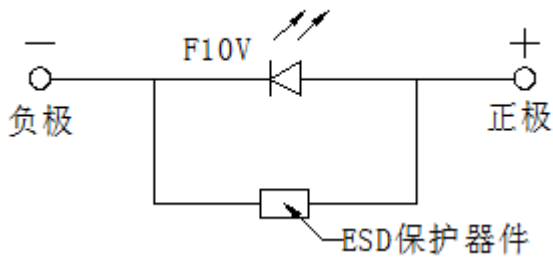
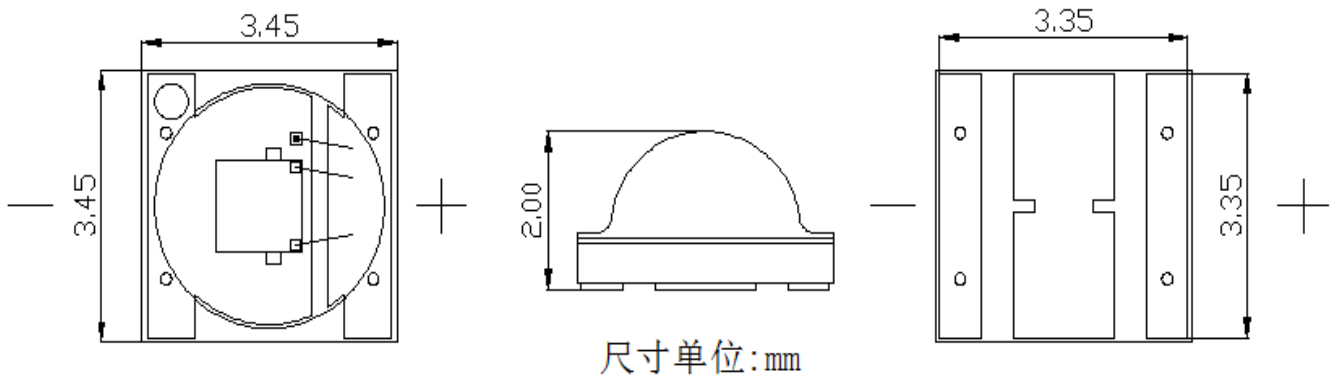

Fig.5- 空间光谱分布图



Package Dimensions 封装尺寸



Welded plate and steel mesh Dimensions 焊盘及钢网尺寸

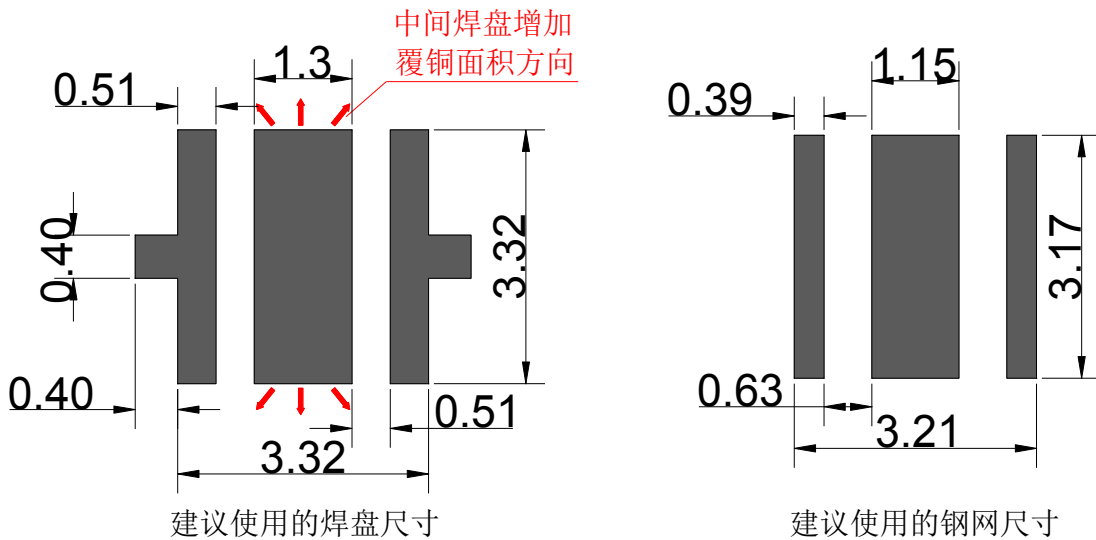

PCB pad dimensions (unit: mm)
PCB焊盘外形尺寸 (单位: mm)



Steel mesh size (unit: mm)
钢网尺寸 (单位: mm)

Notes 注:

[1]. Tolerances unless otherwise mentioned are $\pm 0.15\text{mm}$. 公差为 $\pm 0.15\text{mm}$, 除非另有说明.

Label 标签

 HONGLITRONIC 鸿利光电		
TYPE:XXXXXXXXXX	QTY:XXX PCS	
Bin:		
Φe:	WP:	VF:
DATE:	LOT.NO:	

 HONGLITRONIC 鸿利光电	成品标示卡 (Product Identity Card) 
品名(Description):	
产品型号(Type):	
发光颜色(Color):	
数量(QTY):	
生产批号(LOT NO):	
出货日期(Date):	
操作员(Operator):	

Label on ESD shielding 静电袋上标签

Φe: Luminous Flux rank 辐射通量档次范围

VF: Forward voltage rank 正向电压档次范围

WP: Peak Length 峰值波长

LOT.NO: Lot Number 生产批号

Label on box 外箱标签

Tape Specifications(Units:mm)载带规格 (单位:mm)

已装入产品的格子 (1000PCS)

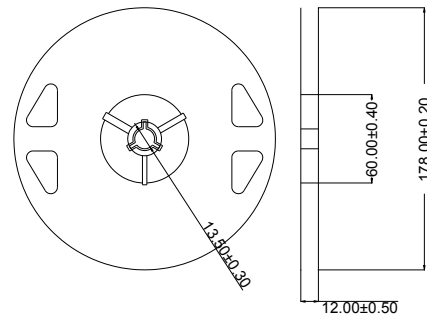
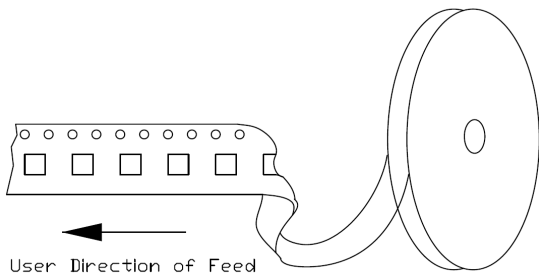
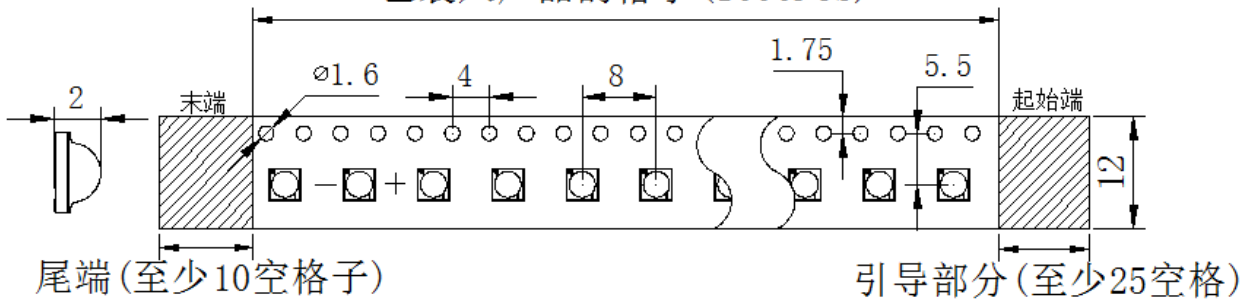

Moisture resistant packaging 防潮包装

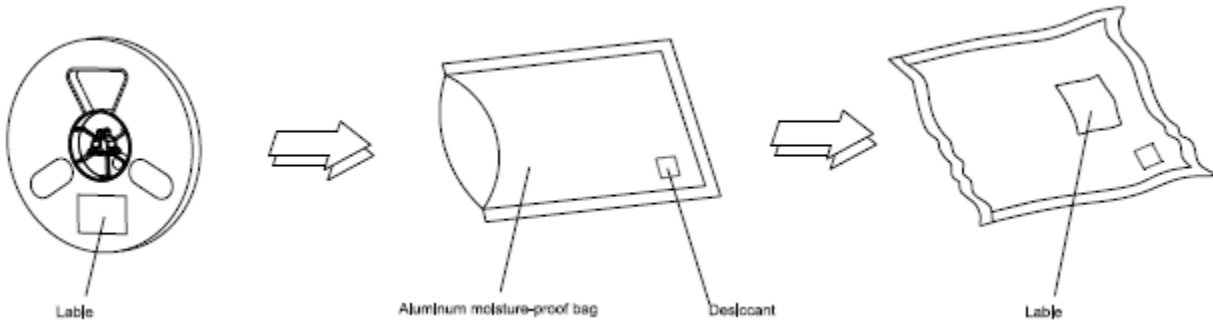



Reflow soldering instructions 回流焊说明

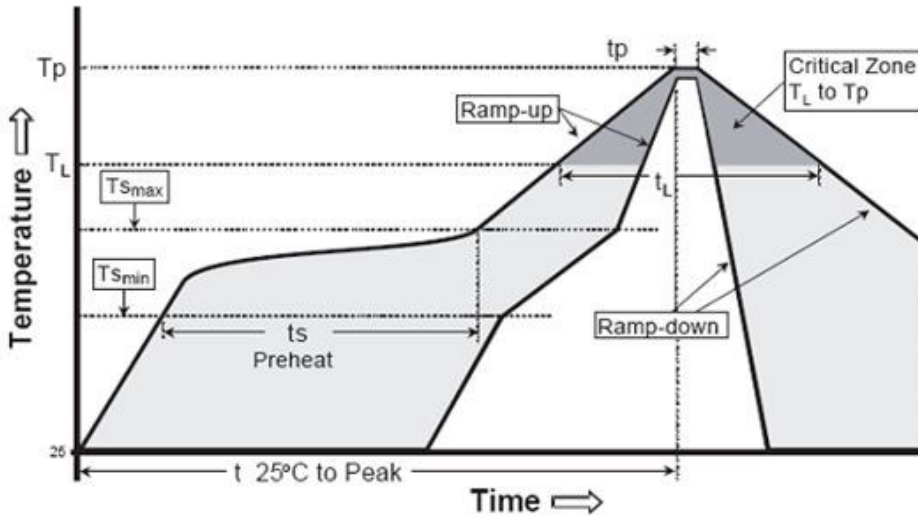

Profile Feature	Lead-Based solder	Lead-Free Solder
Average Ramp-Rate ($T_{s_{max}}$ to T_p)	3°C/second max	3°C/second max
Preheat: Temperature Min ($T_{s_{min}}$)	100°C	150°C
Preheat: Temperature Max ($T_{s_{max}}$)	150°C	200°C
Preheat: Time ($t_{s_{min}}$ to $t_{s_{max}}$)	60-120 seconds	60-180 seconds
Time Maintained Above: Temperature (T_L)	183°C	217°C
Time Maintained Above: Time (t_L)	60-150 seconds	60-150 seconds
Peak/Classification Temperature (T_p)	215°C	260°C
Time Within 5°C of Actual Peak Temperature (t_p)	10-15 seconds	20-40 seconds
Ramp-Down Rate	6°C/second max	6°C/second max
Time 25°C to Peak Temperature	6 minutes max	8 minutes max

Note:

- 1.Reflow soldering should not be done more than two times. In the case of more than 24 hours passed soldering after first, LEDs will be damaged. 回流焊次数不可以超过两次，两次回流焊的时间间隔如果超过24小时，LED可能由于吸湿而损坏。
- 2.When soldering , do not put stress on the LEDs during heating. 当焊接时，不要在材料受热时用力压透镜表面。
- 3.It is commended that use the middle temperature solder past. 推荐使用中温锡膏生产加工。
- 4.After soldering, do not deal with the product before its temperature drop down to room temperature. 在焊接完成后，待产品温度下降到室温后，再进行其它处理。
- 5.When hand soldering, keep the temperature of iron below less 350°C less than 5 seconds. 当手工焊接时，烙铁的温度必须小于350°C，时间不可超过5秒。
- 6.The hand solder should be done only one time. 手工焊接只可焊接一次。
7. Repair should not be done after the LEDs have been soldered. When repairing is unavoidable, a double-head soldering iron should be used (as below figure). It should be confirmed in advance whether the characteristics of LEDs will or will not be damaged by repairing. LED回流焊后不应该修复，当必须修复时，必须使用双头烙铁，而且事先应确认此种方式会不会损坏LED本身的特性。

Reliability Test Items And Conditions 信赖性测试项目及条件

Test Items 项目	Test Condition 测试条件	Time 时间	Quantity 数量	Ac/Re 接收/拒收
Reflow 回流焊	Temp:260°Cmax T=10 sec	3 times.	11Pcs.	0/1
Thermal Shock 冷热冲击	-45°C-125°C 15min/10s/15min	100 Cycles	11Pcs.	0/1
High Temperature Storage 高温保存	Temp:100°C±5°C	500Hrs.	11Pcs.	0/1
Low Temperature Storage 低温保存	Temp:-40°C±5°C	500Hrs.	11Pcs.	0/1
Life Test 常温通电	Ta=25°C±5°C IF=1000mA	1000Hrs.	11Pcs.	0/1

Failure Criteria 失效判定标准

Test Items 项目	Symbol 符号	Test Condition 测试条件	Failure Criteria 判定标准	
			Min. 最小	Max. 最大
Forward Voltage 正向电压	VF	IF=1000mA	--	U.S.L*)x1.1
Radiation Flux 辐射通量	Φ e	IF=1000mA	L.S.L*)x0.7	--

U.S.L: Upper Specification Limit 规格上限

L.S.L: Lower Specification Limit 规格下限

*The technical information shown in the data sheets are limited to the typical characteristics and circuit examples of the referenced products. It does not constitute the warranting of industrial property nor the granting of any license.
 数据工作表中所示的技术信息仅限于典型特征和电路实例引用的产品。它既不构成工业特性的保证，也不构成任何许可的授权。

Use the matters needing attention(使用注意事项)

1、LED operating environment and sulfur element composition cannot be over 100PPM in the LED mating usage material. This is provided for informational purposes only and is not a warranty or endorsement.

LED工作环境及与LED适配的材料中硫元素及化合物成份不可超过100PPM。这只是一个建议，不作任何品质担保。

2、In order to prevent external material from getting into the inside of LED, which may cause the malfunction of LED, the single content of Bromine element is required to be less than 900PPM, the single content of Chlorine element is required to be less than 900PPM, the total content of Bromine element and Chlorine element in the external materials of the application products is required to be less than 1500PPM. This is provided for informational purposes only and is not a warranty or endorsement.

为了防止外界物质进入LED内部以造成LED的损伤，所处环境及所用套件等等，单一的溴元素含量要求小于900PPM，单一氯元素含量要求小于900PPM，溴元素与氯元素总含量必须小于1500PPM。这只是一个建议，不作任何品质担保。

3、VOCs (Volatile organic compounds) emitted from materials used in the construction of fixtures can penetrate silicone encapsulants of LEDs and discolor when exposed to heat and photonic energy. The result can be a significant loss of light output from the fixture. Knowledge of the properties of the materials selected to be used in the construction of fixtures can help prevent these issues. Rafand advises against the use of any chemicals or materials that have been found or are suspected to have an adverse affect on device performance or reliability. To verify compatibility, Rafand recommends that all chemicals and materials be tested in the specific application and environment for which they are intended to be used. Attaching LEDs, do not use adhesives that outgas organic vapor.

应用套件中的挥发性物质会渗透到LED内部，在通电产生光子及热的条件下，会导致LED变色，进而造成严重光衰，提前了解套件材料能够避免产生这些问题。我司反对使用任何对LED器件的性能或者可靠性有害的物质或材料，不管这些材料是已经证实了的还是仅仅怀疑有害。针对特定的用途和使用环境，我司建议对所有的物质和材料进行相容性的测试。在贴装LED时候，不要使用能产生有机挥发性气体的粘结剂。

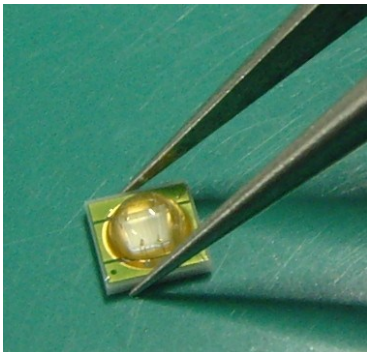

OK

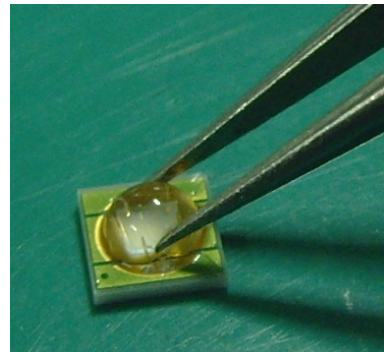

NG

Use the matters needing attention(使用注意事项)

4、 Handle the component along the side surface by using forceps or appropriate tools; do not directly touch or Handle the lens surface, it may damage the internal circuitry. 通过使用适当的工具从材料侧面夹取，不可直接用手或尖锐金属压透镜表面，它可能会损坏内部电路。

5、 In designing a circuit, the current through each LED must be exceed the absolute maximum rating specified for each LED. The driving circuit must be designed to allow forward voltage only when it is ON or OFF. If the reverse voltage is applied to LED, migration can be generated resulting in LED damage. 设计电路时，通过LED的电流不能超过规定的最大值。电路设计必须保证只有在开启或者关闭的时候出现正向电压的变化，不要施加反压，否则会损坏LED。

6、 Thermal Design is paramount importance because heat generation may result in the Characteristics decline, such as brightness decreased, color change and so on. Please consider the heat generation of the LEDs when making the system design. LED容易因为自身的发热和环境的温度改变而改变，温度升高会降低LED发光效率，影响发光颜色，所以在设计时应充分考虑散热问题。

7、 Compared to standard encapsulants and the surface is more likely to attract dust, requiring special care during processing. In cases where a minimal level of dirt and dust particles cannot be guaranteed, a suitable cleaning solution must be applied to the surface after the soldering of components. Rafand suggests using isopropyl alcohol for cleaning. In case other solvents are used, it must be assured that these solvents do not dissolve the package or resin. Ultrasonic cleaning is not recommended. Ultrasonic cleaning may cause damage to the LED. 与其他封装胶相比，应用时应特别注意，当对产品洁净度要求较高时，回流焊以后需要采用恰当的清洗方式，我们推荐用异丙醇作清洗剂，如需要用到其他清洗剂，必须保证不会破坏封装体，超声清洗可能会对LED带来损害，不推荐这种清洗方式。

8、 To avoid the moisture penetration, we recommend store in a dry box with a desiccant. The recommended storage temperature range is 5°C to 30°C and a maximum humidity of RH50%. If the color of the desiccant changes, components should be dried for 10-12hr at 60±5°C. 为了避免湿气进入，产品应该保存在干燥的地方，同时需要使用干燥剂，推荐的储存温度是5°C到30°C，最大湿度不能超过50%,如果湿度卡和干燥剂变色了，需要烘烤10-24小时，烘烤温度为60±5°C。

9、 Similar to most Solid state devices; LEDs are sensitive to Electro-Static Discharge (ESD) and Electrical Over Stress (EOS). 像其他的半导体电子器件一样，LED对静电过流击穿非常敏感，需要做好防护。

10、 Eye Safety Guidelines 眼睛安全准则

- Do not view directly in to the UV light of LED driven at low current or the LED with optical instruments for measuring such as radiant flux, light distribution and spectrum, etc. 请勿直视小电流驱动的LED或使用光学仪器测量辐射通量，光分布和光谱等的LED的紫外线。

- Do not expose to the human body and eyes during the LED light emitting because UV light can be hazardous for human. 在LED发光期间，请勿将其暴露于人体和眼睛，因为紫外线可能对人体有害。

-Please wear UV protective products such as UV protective glasses, mask, etc. 请佩戴防紫外线产品，例如防紫外线眼镜，面罩等。

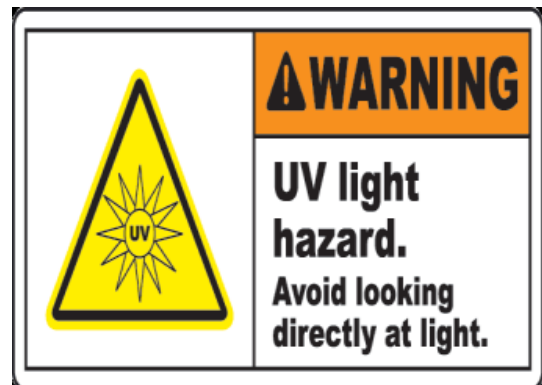

11、 Other points for attention, please refer to our LED usermanual. After the product life cycle for recycling. 其它注意事项请参照LED使用手册。产品生命周期后进行回收处理。

修订次数	修订人	修订内容	修订日期	版次
1	张强	新建文件	2016. 5. 16	A/0
2	赵明深	增加产品分级、可靠性测试、使用注意事项更新、特性曲线图更新	2020. 7. 31	A/1
3	李志强	更新产品使用电流, 分档范围及尺寸误差	2022. 1. 10	A/2
4				
5				
6				
7				
8				
9				
10				
11				
12				
13				
14				
15				
16				
17				
18				
19				
20				
21				
22				
23				
24				