

**Feature**

- 30V,150A  
 $R_{DS(on)} < 3.2m\Omega @ V_{GS}=10V$   
 $R_{DS(on)} < 6.2m\Omega @ V_{GS}=4.5V$
- Advanced Trench Technology
- Lead free product is acquired
- Excellent  $R_{DS(on)}$  and Low Gate Charge

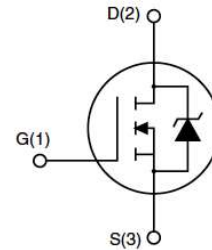

**Application**

- PWM applications
- Load Switch
- Power management

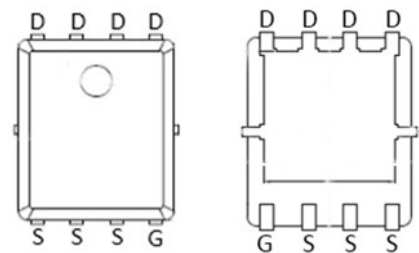

PDFN5X6-8L

**Package Marking and Ordering Information**

Device Marking	Device	Device Package	Reel Size	Tape width	Quantity (PCS)
150N03G	AP150N03G	PDFN5*6-8L	13 inch	-	5000

**ABSOLUTE MAXIMUM RATINGS ( $T_a=25^{\circ}C$  unless otherwise noted)**

Parameter	Symbol	Value	Unit
Drain-Source Voltage	$V_{DS}$	30	V
Gate-Source Voltage	$V_{GS}$	$\pm 20$	V
Continuous Drain Current ( $T_a = 25^{\circ}C$ )	$I_D$	150	A
Continuous Drain Current ( $T_a = 100^{\circ}C$ )	$I_D$	105	A
Pulsed Drain Current <sup>(1)</sup>	$I_{DM}$	570	A
Singel Pulsed Avalanche Energy <sup>(2)</sup>	$E_{AS}$	225	mJ
Power Dissipation	$P_D$	154	W
Thermal Resistance from Junction to Case	$R_{\theta JC}$	0.97	$^{\circ}C/W$
Junction Temperature	$T_J$	150	$^{\circ}C$
Storage Temperature	$T_{STG}$	-55~ +150	$^{\circ}C$

MOSFET ELECTRICAL CHARACTERISTICS( $T_a=25^{\circ}\text{C}$  unless otherwise noted)

Parameter	Symbol	Test Condition	Min	Type	Max	Unit
<b>Static Characteristics</b>						
Drain-source breakdown voltage	$V_{(BR)DSS}$	$V_{GS} = 0V, I_D = 250\mu A$	30	-	-	V
Zero gate voltage drain current	$I_{DSS}$	$V_{DS} = 30V, V_{GS} = 0V$	-	-	1	$\mu A$
Gate-body leakage current	$I_{GSS}$	$V_{GS} = \pm 20V, V_{DS} = 0V$	-	-	$\pm 100$	nA
Gate threshold voltage <sup>(3)</sup>	$V_{GS(th)}$	$V_{DS} = V_{GS}, I_D = 250\mu A$	1	1.7	2.5	V
Drain-source on-resistance <sup>(3)</sup>	$R_{DS(on)}$	$V_{GS} = 10V, I_D = 30A$	-	2.4	3.2	m $\Omega$
		$V_{GS} = 4.5V, I_D = 20A$	-	4.5	6.2	
<b>Dynamic characteristics</b>						
Input Capacitance	$C_{iss}$	$V_{DS} = 15V, V_{GS} = 0V, f = 1MHz$	-	3500	-	pF
Output Capacitance	$C_{oss}$		-	500	-	
Reverse Transfer Capacitance	$C_{rss}$		-	431	-	
<b>Switching characteristics</b>						
Turn-on delay time	$t_{d(on)}$	$V_{DD} = 15V, I_D = 30A, R_L = 1\Omega$ $V_{GS} = 10V, R_G = 3\Omega$	-	26	-	ns
Turn-on rise time	$t_r$		-	24	-	
Turn-off delay time	$t_{d(off)}$		-	91	-	
Turn-off fall time	$t_f$		-	39	-	
Total Gate Charge	$Q_g$	$V_{DS} = 15V, I_D = 30A,$ $V_{GS} = 10V$	-	38	-	nC
Gate-Source Charge	$Q_{gs}$		-	9	-	
Gate-Drain Charge	$Q_{gd}$		-	13	-	
<b>Source-Drain Diode characteristics</b>						
Diode Forward voltage <sup>(3)</sup>	$V_{DS}$	$V_{GS} = 0V, I_S = 30A$	-	-	1.2	V
Diode Forward current <sup>(4)</sup>	$I_S$		-	-	150	A

**Notes:**

1. Repetitive Rating: pulse width limited by maximum junction temperature
2. EAS Condition:  $T_J = 25^{\circ}\text{C}, V_{DD} = 15V, R_G = 25\Omega, L = 0.5mH, I_{AS} = 30A$
3. Pulse Test: pulse width  $\leq 300\mu s$ , duty cycle  $\leq 2\%$
4. Surface Mounted on FR4 Board,  $t \leq 10$  sec

**Test Circuit**

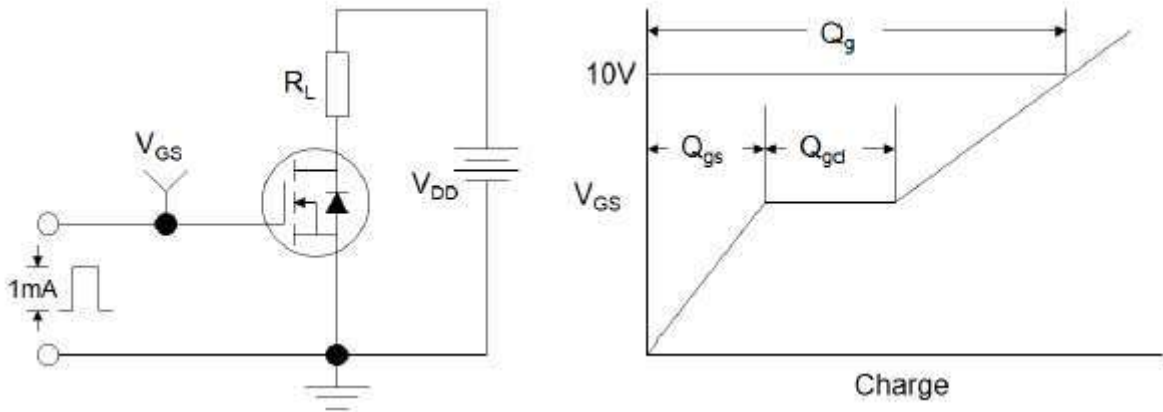

Figure1:Gate Charge Test Circuit & Waveform

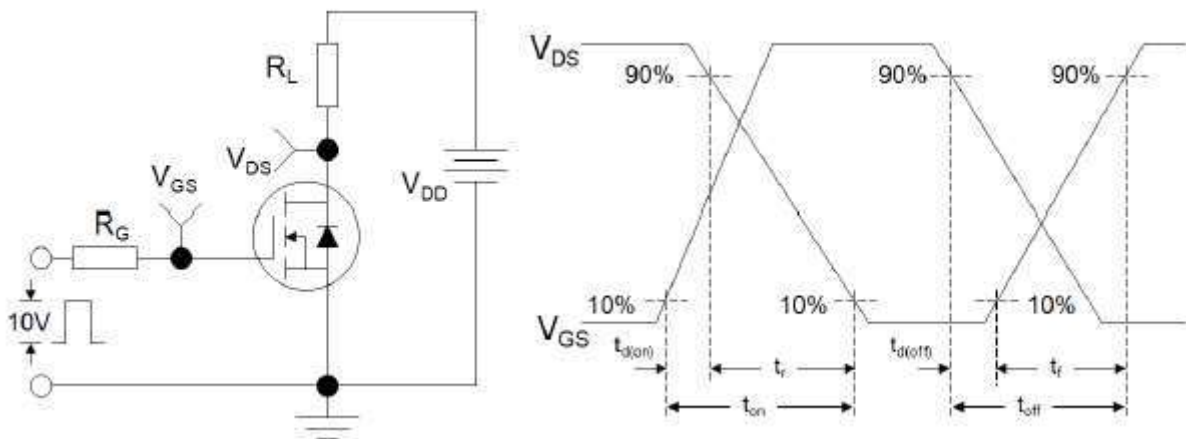

Figure 2: Resistive Switching Test Circuit & Waveforms

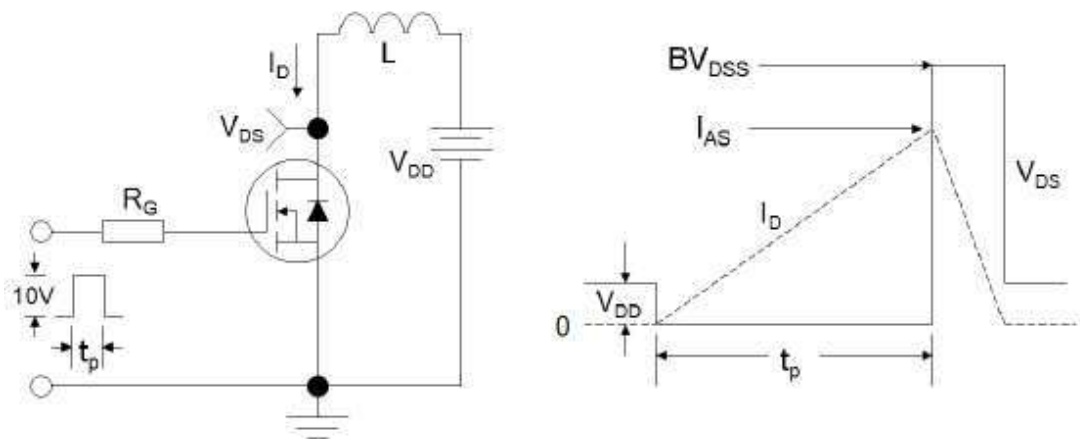
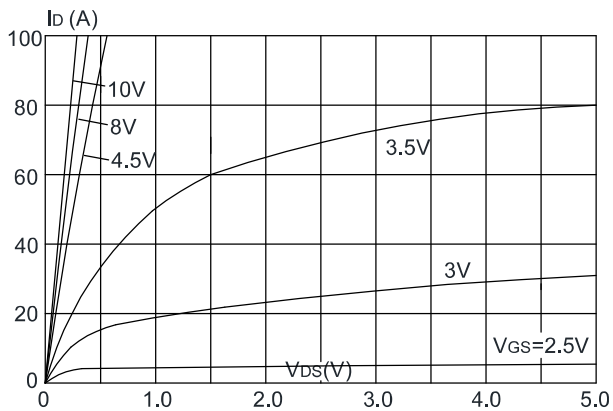
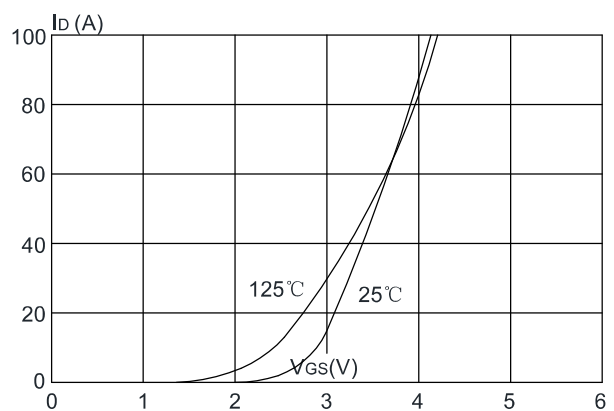

Figure 3:Unclamped Inductive Switching Test Circuit & Waveforms

**Figure 1: Output Characteristics**



**Figure 2: Typical Transfer Characteristics**



**Figure 3: On-resistance vs. Drain Current**

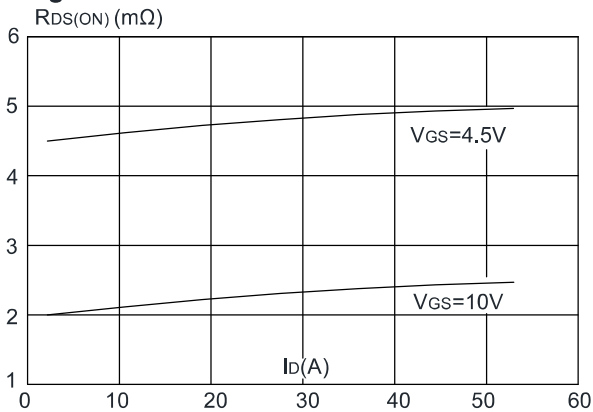

**Figure 4: Body Diode Characteristics**

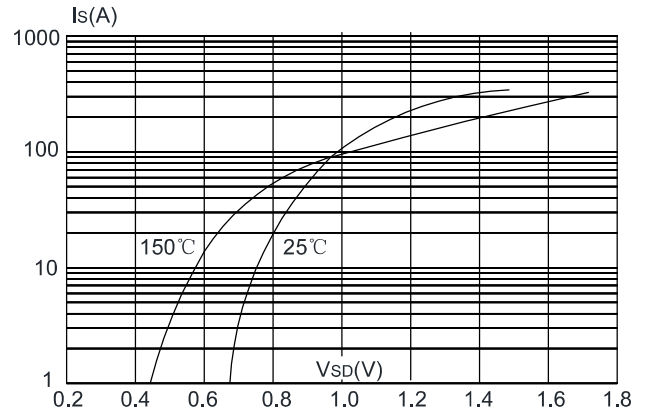

**Figure 5: Gate Charge Characteristics**

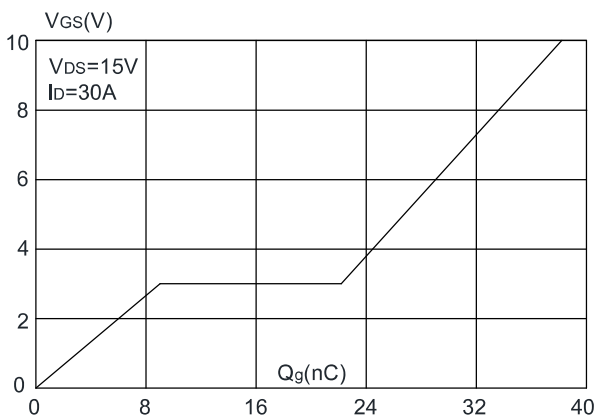

**Figure 6: Capacitance Characteristics**

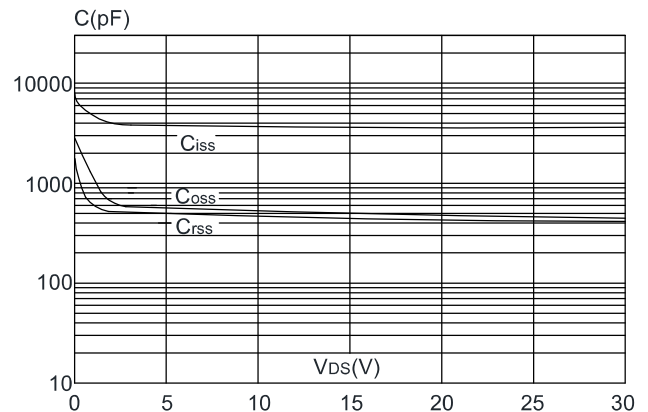

**Figure 7:** Normalized Breakdown Voltage vs. Junction Temperature

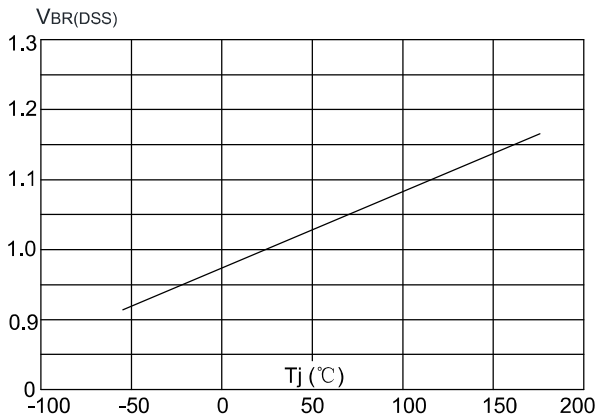

**Figure 8:** Normalized on Resistance vs. Junction Temperature

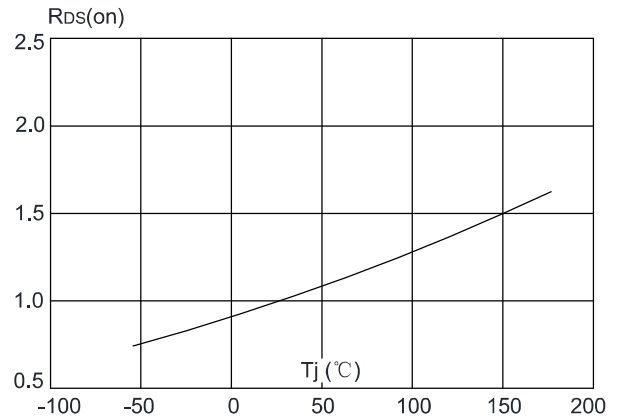

**Figure 9:** Maximum Safe Operating Area

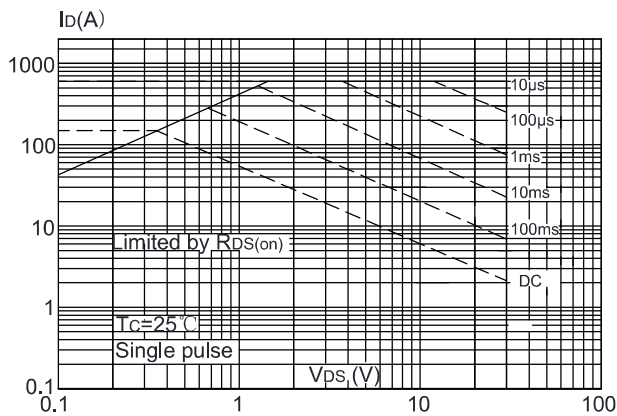

**Figure 10:** Maximum Continuous Drain Current vs. Case Temperature

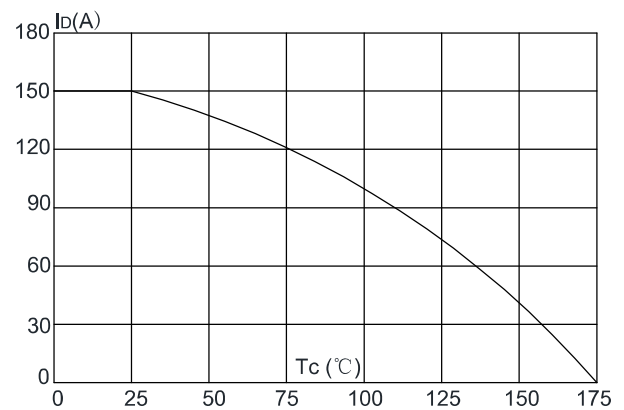

**Figure 11:** Maximum Effective Transient Thermal Impedance, Junction-to-Case

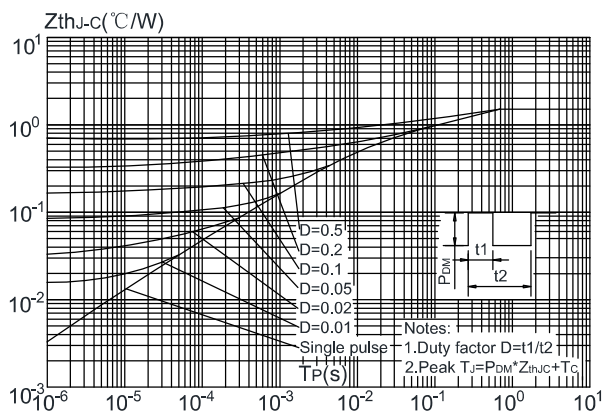

**PDFN5\*6-8L Package Information**

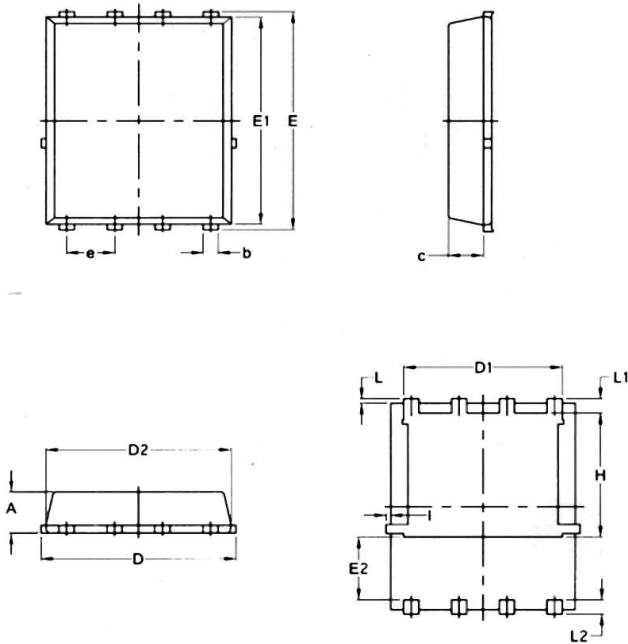

PDFN5X6-8L

SYMBOL	COMMON			
	MM		INCH	
	MIN.	MAX.	MIN.	MAX.
A	1.03	1.17	0.0406	0.0461
b	0.34	0.48	0.0134	0.0189
c	0.824	0.970	0.0324	0.0382
D	4.80	5.40	0.1890	0.2126
D1	4.11	4.31	0.1618	0.1697
D2	4.80	5.00	0.1890	0.1969
E	5.95	6.15	0.2343	0.2421
E1	5.65	5.85	0.2224	0.2303
E2	1.60	—	0.0630	—
e	1.27 BSC		0.05 BSC	
L	0.05	0.25	0.0020	0.0098
L1	0.38	0.50	0.0150	0.0197
L2	0.38	0.50	0.0150	0.0197
H	3.30	3.50	0.1299	0.1378
I	—	0.18	—	0.0070