

承认书

APPROVAL SHEET

厂商：丽智电子（昆山）有限公司

客户：_____

：丽智电子（南通）有限公司

Supplier:

customer:

| 核准 Approved by | 审核 Checked by | 制作 Prepared by |
|-------------------|------------------|-------------------|
| | | |

地址：江苏省昆山市汉浦路 989 号

Address: No. 989, Hanpu Road Kunshan City Jiangsu Province

Tel:0086-0512-57780531

Fax:0086-0512-57789581

地址：江苏省南通市通州区康富路 789 号

Address: No. 789, Kang Fu Road Tongzhou District Nantong city Jiangsu province

Tel: 0086-0513-68856666

Fax: 0086-0513-68383688

厚膜贴片电阻承认书-CR 系列

Approval Specification for Thick Film Chip Resistors - Type **CR**

1. 范围 (scope) :

1.1 适用于本公司所生产的无铅、无卤之厚膜贴片电阻 CR 系列

This specification applies to thick film chip resistors which meet requirements of Pb free and halogen free.

1.2 本公司的无铅产品指的贴片电阻端电极无铅，而存在于电阻层的玻璃中的符合 RoHS 豁免条款。

There no lead exists in terminal of resistor, and lead which exist in glass of resistor layer meets RoHS exemption.

2. 产品料号 (part number) :

0603 1/10W 5% 100 Ω





CR0603JA0101G

| <u>CR</u> | <u>0603</u> | <u>J</u> | <u>A</u> | <u>0101</u> | <u>G</u> |
|--|--|--|--|--|--|
| ↓ | ↓ | ↓ | ↓ | ↓ | ↓ |
| 类型(Type) CR: 厚膜贴片 电阻(thick film chip resistors) | 尺寸(Size) 0201 0402 0603 0805 1206 1210 1812 2010 2512 | 公差 Tolerance B=±0.1% D=±0.5% F=±1% G=±2% J=±5% K=±10% | 额定功率 Rated Power 1= 1W 2= 1/2W 2= 3/4W (for 2010) 3=1/3W 3= 1/2W (for 1210) 4= 1/4W 8= 1/8W A= 1/10W F= 1/16W H=1/20W | 阻值 Resistance value ±1% , ±0.5% : 49R9=49.9 Ω 1002=10K Ω ±2% , ±5% : 06R8=6.8 Ω 0564=560K Ω | 包装代码 Packing Code G= reel (卷装) V= bulk (散料) S= Double Standard Quantity (两倍卷 盘标准包装量) |

厚膜贴片电阻承认书-CR 系列

Approval Specification for Thick Film Chip Resistors - Type **CR**

3. 电阻本体字码标示(Marking on the Resistor's Body):

| | | |
|---|--|---|
| <p>※ 0201 及 0402 因本体太小，本体上无字码标示 For 0201 and 0402 size, no marking on the body due to the small size of the resistor</p> |  | <p>472=47×10²=4.7KΩ</p> |
| <p>※ 公差±5%的产品，以三字码标示，前两位表示阻值的有效数字，最后一位表示 10 的乘幂 ±5% tolerance product: the marking is 3 digits, the first 2 digits are significant figures of resistance value and the 3rd one denotes the power number of 10, (10^x)</p> |  | <p>10Ω 以下标示: 5R6=5.6Ω Below 10Ω: 5R6=5.6Ω</p> |
| <p>※ ±0.5%, ±1%的产品，以四字码标示，前三位表示阻值的有效数字，最后一位表示 10 的乘幂 ±0.5%, ±1% tolerance product: the marking is 4 digits, the first 3 digits are significant figures of resistance value and the 4th one denotes the power number of 10, (10^x)</p> |  | <p>4992=499×10²=49.9KΩ</p> |
| <p>※ 0603 ±1% E96 系列的标准阻值，因电阻本体太小，采用三位代码标示。 Standard E96 series values of 0603 ±1%: due to the small size of the resistor's body, use 3digits code to indicate the resistance value.</p> |  | <p>100Ω 以下标示: 6R81=6.81Ω Below 100Ω: 6R81=6.81Ω</p> |
| <p>※ 0 欧姆产品，采用 000 三位代码标示。 0Ω Products, use 000 3digits code to indicate the resistance value.</p> |  | <p>000=0Ω</p> |

厚膜贴片电阻承认书-CR 系列

Approval Specification for Thick Film Chip Resistors - Type **CR**

0603 ±1% E96 系列的标准阻值代码(Standard E96 Series Resistance Value Code for 0603 ±1% Marking)

| 代码 Code | 阻值 Value | 代码 Code | 阻值 Value | 代码 Code | 阻值 Value | 代码 Code | 阻值 Value | 代码 Code | 阻值 Value | 代码 Code | 阻值 Value |
|---------|----------|---------|----------|---------|----------|---------|----------|---------|----------|---------|----------|
| 01 | 100 | 17 | 147 | 33 | 215 | 49 | 316 | 65 | 464 | 81 | 681 |
| 02 | 102 | 18 | 150 | 34 | 221 | 50 | 324 | 66 | 475 | 82 | 698 |
| 03 | 105 | 19 | 154 | 35 | 226 | 51 | 332 | 67 | 487 | 83 | 715 |
| 04 | 107 | 20 | 158 | 36 | 232 | 52 | 340 | 68 | 499 | 84 | 732 |
| 05 | 110 | 21 | 162 | 37 | 237 | 53 | 348 | 69 | 511 | 85 | 750 |
| 06 | 113 | 22 | 165 | 38 | 243 | 54 | 357 | 70 | 523 | 86 | 768 |
| 07 | 115 | 23 | 169 | 39 | 249 | 55 | 365 | 71 | 536 | 87 | 787 |
| 08 | 118 | 24 | 174 | 40 | 255 | 56 | 374 | 72 | 549 | 88 | 806 |
| 09 | 121 | 25 | 178 | 41 | 261 | 57 | 383 | 73 | 562 | 89 | 825 |
| 10 | 124 | 26 | 182 | 42 | 267 | 58 | 392 | 74 | 576 | 90 | 845 |
| 11 | 127 | 27 | 187 | 43 | 274 | 59 | 402 | 75 | 590 | 91 | 866 |
| 12 | 130 | 28 | 191 | 44 | 280 | 60 | 412 | 76 | 604 | 92 | 887 |
| 13 | 133 | 29 | 196 | 45 | 287 | 61 | 422 | 77 | 619 | 93 | 909 |
| 14 | 137 | 30 | 200 | 46 | 294 | 62 | 432 | 78 | 634 | 94 | 931 |
| 15 | 140 | 31 | 205 | 47 | 301 | 63 | 442 | 79 | 649 | 95 | 953 |
| 16 | 143 | 32 | 210 | 48 | 309 | 64 | 453 | 80 | 665 | 96 | 976 |

0603 ±1% E96 系列的指数代码(Multiplier Code for 0603 ±1% Marking)

| 代码 Code | Y | X | A | B | C | D | E | F |
|---------------|-----------|-----------|--------|--------|--------|--------|--------|--------|
| 指数 Multiplier | 10^{-2} | 10^{-1} | 10^0 | 10^1 | 10^2 | 10^3 | 10^4 | 10^5 |

阻值标示如下(So the resistance value are marked as the following examples)



$$10D=124 \times 10^3=124K \Omega$$



$$38Y=243 \times 10^{-2}=2.43 \Omega$$

0603 ±1%的产品，在标准 E24 系列中，但不属于 E96 系列，标示与 5%的字码相同，但是在字码下加一条线
 Standard E24 and not belong to E96 series values of 0603 ±1%, the marking is the same as 5% tolerance but marking as underline



$$\underline{331}=33 \times 10^1=330 \Omega$$



$$\underline{560}=56 \times 10^0=56 \Omega$$

厚膜贴片电阻承认书-CR 系列

Approval Specification for Thick Film Chip Resistors - Type **CR**

4. 尺寸 (dimension) :

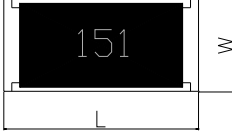
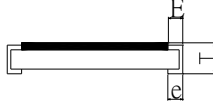
| 尺寸 dimension |  | |  | | |
|-----------------|---|-----------|---|-----------|-----------|
| | 单位 (unit) : mm | | | | |
| 型别 (Type) | L | W | T | E | e |
| CR0201 | 0.60±0.03 | 0.30±0.03 | 0.23±0.03 | 0.10±0.05 | 0.15±0.05 |
| CR0402 | 1.00±0.05 | 0.50±0.05 | 0.30±0.05 | 0.15±0.10 | 0.20±0.10 |
| CR0603 | 1.60±0.10 | 0.80±0.10 | 0.45±0.10 | 0.25±0.20 | 0.30±0.20 |
| CR0805 | 2.00±0.15 | 1.25±0.15 | 0.50±0.10 | 0.35±0.20 | 0.40±0.20 |
| CR1206 | 3.10±0.15 | 1.60±0.15 | 0.55±0.10 | 0.45±0.25 | 0.40±0.25 |
| CR1210 | 3.10±0.15 | 2.50±0.15 | 0.55±0.15 | 0.35±0.25 | 0.60±0.25 |
| CR1812 | 4.50±0.20 | 3.10±0.20 | 0.55±0.15 | 0.55±0.20 | 0.70±0.20 |
| CR2010 | 5.00±0.20 | 2.50±0.20 | 0.55±0.15 | 0.65±0.25 | 0.50±0.25 |
| CR2512 | 6.25±0.20 | 3.10±0.20 | 0.55±0.15 | 0.85±0.25 | 0.95±0.25 |

5. 功率衰减曲线 (Derating Curve) :

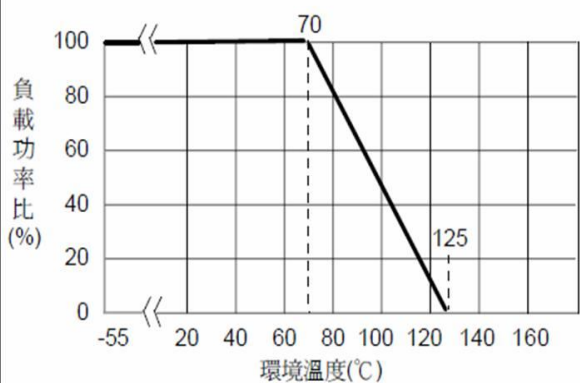
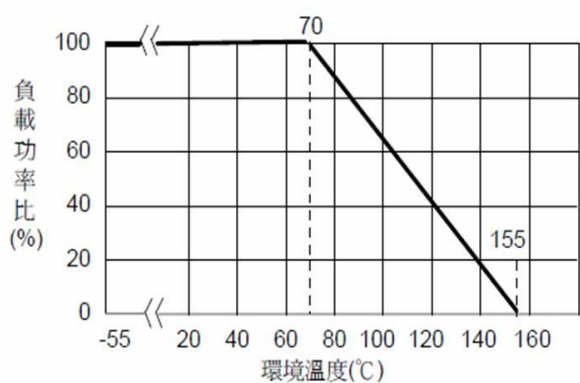
| 使用 溫度範圍 | -55°C ~ +125°C (0201) | -55°C ~ +155°C (其他) |
|---------------------|---|--|
| 說明 | 周圍溫度若超過70°C至125°C之間，功率可照下圖曲線予以修定之。 | 周圍溫度若超過70°C至155°C之間，功率可照下圖曲線予以修定之。 |
| 功率 衰減 曲線 圖 |  |  |

工作溫度範圍 (Operating Temperature Range) : -55°C ~ +155°C;

儲存條件 (storage condition) : 5~30°C, 30~75%RH.

厚膜贴片电阻承认书-CR 系列

Approval Specification for Thick Film Chip Resistors - Type **CR**

6.电阻结构（Construction）：

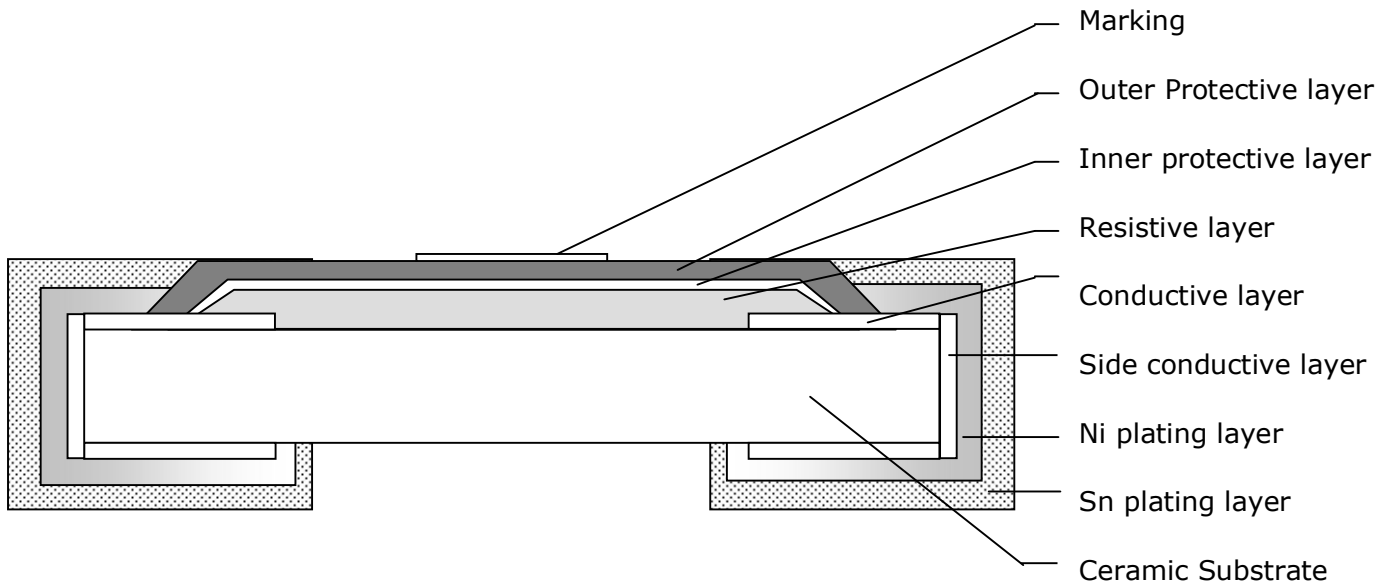

| No. | 结构 construction | 主要材料 Major material |
|-----|--------------------------------|---|
| 1 | 陶瓷基板 Ceramic substrate | 三氧化二铝 Al ₂ O ₃ |
| 2 | 银电极 Conductive layer | 银 Ag |
| 3 | 侧电极 Side conductive layer | 镍铬合金 NiCr |
| 4 | 阻体层 Resistive layer | 氧化钌+玻璃 RuO ₂ + glass |
| 5 | 内保护层 Inner protective layer | 玻璃 Glass |
| 6 | 外保护层 Outer Protective layer | 环氧树脂 Epoxy |
| 7 | 文字 Marking | 环氧树脂 Epoxy |
| 8 | 镍电极 Ni plating layer | 镍 Ni |
| 9 | 锡电极 Sn plating layer | 雾锡 Matte Tin |

厚膜贴片电阻承认书-CR 系列

Approval Specification for Thick Film Chip Resistors - Type **CR**

7. 阻值范围 (resistance range) :

| 型别 Type | 阻值范围 Resistance Range | | | |
|---------|--------------------------|---------|---------|----------|
| | 0.5% | 1% | 2% | 5% |
| CR0201 | - | 1Ω~10MΩ | 1Ω~10MΩ | 1Ω~10MΩ |
| CR0402 | 10Ω~1MΩ | 1Ω~22MΩ | 1Ω~22MΩ | 1Ω~22MΩ |
| CR0603 | 10Ω~1MΩ | 1Ω~22MΩ | 1Ω~22MΩ | 1Ω~100MΩ |
| CR0805 | 10Ω~1MΩ | 1Ω~22MΩ | 1Ω~22MΩ | 1Ω~100MΩ |
| CR1206 | 10Ω~1MΩ | 1Ω~22MΩ | 1Ω~22MΩ | 1Ω~100MΩ |
| CR1210 | 10Ω~1MΩ | 1Ω~22MΩ | 1Ω~22MΩ | 1Ω~100MΩ |
| CR1812 | 10Ω~1MΩ | 1Ω~10MΩ | 1Ω~10MΩ | 1Ω~10MΩ |
| CR2010 | 10Ω~1MΩ | 1Ω~22MΩ | 1Ω~22MΩ | 1Ω~100MΩ |
| CR2512 | 10Ω~1MΩ | 1Ω~22MΩ | 1Ω~22MΩ | 1Ω~100MΩ |

8. 电气特性 (electrical characteristics) :

| 型别 Type | CR0201 | CR0402 | CR0603 | CR0805 | CR1206 | CR1210 | CR1812 | CR2010 | CR2512 |
|---|--------|--------|--------|--------|--------|--------|--------|--------|--------|
| 额定功率 Rated power | 1/20W | 1/16W | 1/10W | 1/8W | 1/4W | 1/2W | 1/2W | 3/4W | 1W |
| 最大工作电压 Max Working Voltage | 25V | 50V | 75V | 150V | 200V | 200V | 200V | 200V | 200V |
| 最大过负荷电压 Max Overload Voltage | 50V | 100V | 150V | 300V | 400V | 500V | 500V | 500V | 500V |
| 绝缘耐压 Dielectric Withstanding Voltage | 75V | 150V | 220V | 430V | 570V | 710V | 710V | 710V | 710V |
| 零欧姆阻值 Resistance Value of Jumper | <50mΩ | <50mΩ | <50mΩ | <50mΩ | <50mΩ | <50mΩ | <50mΩ | <50mΩ | <50mΩ |
| 零欧姆额定电流 Rated Current of Jumper | 0.5A | 1.0A | 1.0A | 2.0A | 2.0A | 2.0A | 2.0A | 2.0A | 2.0A |
| 零欧姆电阻最大电流 Max Current of Jumper | 1.0A | 2.0A | 2.0A | 5.0A | 10.0A | 10.0A | 10.0A | 10.0A | 10.0A |

备注 (remark) :

※ 额定电压计算公式 (The rated voltage is calculated by the following formula) :

$$E = \sqrt{RP}$$

E : 额定电压 (Rated Voltage) (V)

P : 额定功率 (Rated Power) (W)

R : 电阻阻值 (Resistance) (ohm)

※ 如果计算出的电压超过此型别的最大工作电压, 则此型别的最大工作电压为此电阻的额定电压。

In case the value calculated by the formula exceed the maximum working voltage as above table 8, the maximum working voltage shall be regarded as rated voltage.

厚膜贴片电阻承认书-CR 系列

Approval Specification for Thick Film Chip Resistors - Type **CR**

9. 性能(Performance Specifications)

| 内容 Item | 规格 Specification Limits | 测试方法 Test Methods |
|---|---|---------------------------|
| 温度系数 Temperature Coefficient | 0201 规格： $1\Omega \leq R \leq 10\Omega$ 产品 (Product) : $-100 \sim +300 \text{PPM}/^\circ\text{C}$ $10\Omega < R \leq 10\text{M}\Omega$ 产品 (Product) : $\pm 200 \text{PPM}/^\circ\text{C}$ 0402~2512 规格： $1\Omega \leq R \leq 10\Omega$ 产品 (Product) : $-200 \sim +400 \text{PPM}/^\circ\text{C}$ $10\Omega < R \leq 10\text{M}\Omega$ 产品 (Product) : $\pm 100 \text{PPM}/^\circ\text{C}$ $10\text{M}\Omega < R \leq 100\text{M}\Omega$ 产品 (Product) : $\pm 200 \text{PPM}/^\circ\text{C}$ | JIS C 5201 4.8 |
| 焊锡性 Solderability | 最少 95%面积上锡(Min 95% coverage) | JIS C 5201 4.17 |
| 绝缘电阻 Insulation resistance | $>10\text{G}\Omega$ | JIS C 5201 4.6 |
| 绝缘耐压 Dielectric withstanding voltage | 无击穿、飞弧及可见机械性损伤 No evidence of flashover, mechanical damage arcing or insulation breakdown | JIS C 5201 4.7 |
| 短时间过负荷 Short-time overload | $\pm 5\% \& \pm 2\%$: $\pm(2.0\% + 0.05\Omega)$ Max (最大) $\pm 1\% \& \pm 0.5\%$: $\pm(1.0\% + 0.05\Omega)$ Max (最大) | JIS C 5201 4.13 |
| 端子弯曲 Terminal bending | $\pm(1.0\% + 0.05\Omega)$ Max (最大) | JIS C 5201 4.33 |
| 抗焊锡热 Resist to soldering heat | $\pm(1.0\% + 0.05\Omega)$ Max (最大) | JIS C 5201 4.18 |
| 负荷寿命 Load life | $\pm(3.0\% + 0.05\Omega)$ Max (最大) | JIS C 5201 4.25.1 |
| 耐湿特性 Humidity | $\pm(2.0\% + 0.05\Omega)$ Max (最大) | JIS C 5201 4.24 |
| 温度循环 Temperature Cycling | $\pm(2.0\% + 0.05\Omega)$ Max (最大) | JIS C 5201 4.19 |
| 温湿循环 Moisture Resistance | $\pm(2.0\% + 0.05\Omega)$ Max (最大) | MIL-STD-202 METHOD 106 |

10. 包装规格 (Tapping Specification)
10.1 卷盘尺寸 (reel dimension)

| 尺寸 Dimensions | | A | B | C | F | W |
|--|------|-------------|-------------|-------------|-------------|-------------|
| CR0201 CR0402 CR0603 CR0805 CR1206 CR1210 | mm | 178±2.0 | 60.0±1.0 | 13.5±0.5 | 11.4±0.1 | 9.00±0.3 |
| | Inch | 7.008±0.079 | 2.362±0.039 | 0.531±0.020 | 0.449±0.039 | 0.354±0.012 |
| CR1812 CR2010 CR2512 | mm | 178±2.0 | 60.0±1.0 | 13.5±0.5 | 15.4±1.0 | 13.0±0.3 |
| | Inch | 7.008±0.079 | 2.362±0.039 | 0.531±0.020 | 0.606±0.039 | 0.512±0.012 |

- ※ 备注 (Remark) :
- (1) 0201/0402 每卷 10,000 pcs
0201/0402 Quantity per Reel 10,000 pcs/Reel
 - (2) 1812/2010/2512 每卷 4,000 pcs
1812/ 2010/2512 Quantity per Reel 4,000 pcs/Reel
 - (3) 0603/0805/1206/1210 每卷 5,000pcs
0603/0805/1206/1210 Quantity per Reel 5,000 pcs/Reel
 - (4) 0402 可依客户要求每卷 20,000pcs
0402 Quantity per Reel 20,000 pcs/Reel as customer requirement

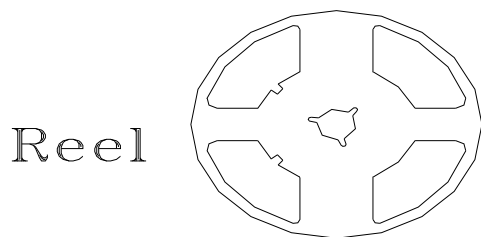

Standard Quantity per Reel
5,000 pcs/Reel

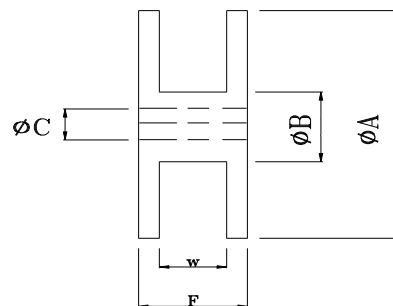

厚膜贴片电阻承认书-CR 系列

Approval Specification for Thick Film Chip Resistors - Type **CR**

10.2 包装尺寸 (packing dimension)

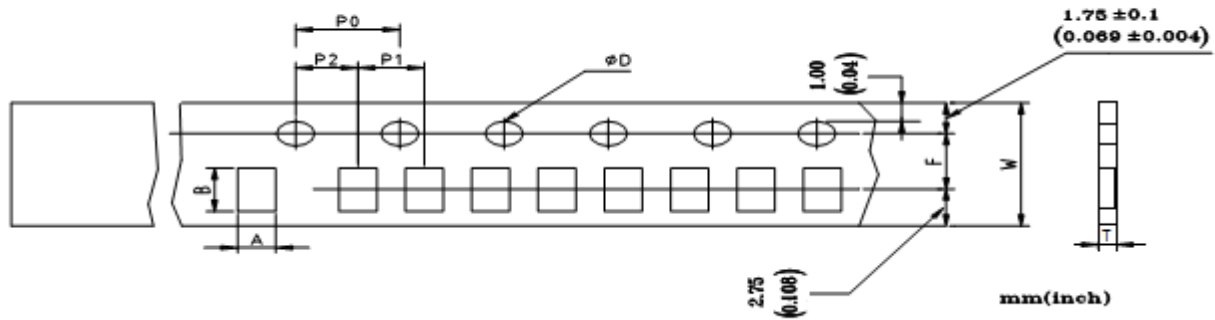

Unit: mm

| Dimensions | A | B | D | F | P0 | P1 | P2 | W | T |
|------------|-----------|-----------|-------------------------------------|-----------|-----------|-----------|-----------|-----------|-----------|
| CR0201 | 0.38±0.05 | 0.68±0.05 | 1.50± _{0.0} ^{0.1} | 3.50±0.05 | 4.00±0.10 | 2.00±0.10 | 2.00±0.05 | 8.00±0.20 | 0.42±0.07 |
| CR0402 | 0.65±0.10 | 1.15±0.10 | 1.50± _{0.0} ^{0.1} | 3.50±0.05 | 4.00±0.10 | 2.00±0.10 | 2.00±0.05 | 8.00±0.20 | 0.42±0.07 |
| CR0603 | 1.10±0.10 | 1.90±0.10 | 1.50± _{0.0} ^{0.1} | 3.50±0.05 | 4.00±0.10 | 4.00±0.10 | 2.00±0.05 | 8.00±0.20 | 0.60±0.07 |
| CR0805 | 1.65±0.20 | 2.40±0.20 | 1.50± _{0.0} ^{0.1} | 3.50±0.05 | 4.00±0.10 | 4.00±0.10 | 2.00±0.05 | 8.00±0.20 | 0.75±0.07 |
| CR1206 | 2.00±0.20 | 3.60±0.20 | 1.50± _{0.0} ^{0.1} | 3.50±0.05 | 4.00±0.10 | 4.00±0.10 | 2.00±0.05 | 8.00±0.20 | 0.75±0.07 |
| CR1210 | 2.80±0.20 | 3.50±0.20 | 1.50± _{0.0} ^{0.1} | 3.50±0.05 | 4.00±0.10 | 4.00±0.10 | 2.00±0.05 | 8.00±0.20 | 0.75±0.07 |
| CR1812 | 3.30±0.20 | 4.60±0.20 | 1.50± _{0.0} ^{0.1} | 5.50±0.05 | 4.00±0.10 | 4.00±0.10 | 2.00±0.05 | 12.0±0.10 | 1.0±0.07 |
| CR2010 | 2.90±0.10 | 5.30±0.10 | 1.50± _{0.0} ^{0.1} | 5.50±0.05 | 4.00±0.10 | 4.00±0.10 | 2.00±0.05 | 12.0±0.10 | 1.0±0.07 |
| CR2512 | 3.40±0.10 | 6.60±0.10 | 1.50± _{0.0} ^{0.1} | 5.50±0.05 | 4.00±0.10 | 4.00±0.10 | 2.00±0.05 | 12.0±0.10 | 1.0±0.07 |

厚膜贴片电阻承认书-CR 系列

Approval Specification for Thick Film Chip Resistors - Type **CR**

11. 信赖性测试 (Reliability Test Methods)

| 内容 Item | 测试条件 Test Conditions |
|---|--|
| 温度系数 Temperature Coefficient | $TCR = (R - R_0) / (t - t_0) R_0 \times 10^6$ (ppm) R_0 电阻在室温下的阻值(resistance at room temperature) R 电阻在 125°C 或 -55°C 下的阻值(resistance at 125°C or -55°C) t_0 室温(room temperature) t 测试温度 (test temperature 125°C or -55°C) |
| 焊锡性 Solderability | 沾助焊剂后浸入锡炉，锡炉温度 245±5°C，时间 2~3 秒 Dip the terminal in a flux and then dip into a soldering bath at 245±5°C for 2~3sec. |
| 绝缘电阻 Insulation resistance | 电阻本体上加载最大的工作电压 60±5 秒后，测量绝缘阻抗 Applied the maximum DC working voltage on the center of body for 60 ± 5seconds. Then measure insulation resistance |
| 绝缘耐压 Dielectric withstanding voltage | 电阻本体上加载最大的工作电压 60±5 秒。 Applied the maximum DC working voltage on the center of body for 60 ± 5seconds. |
| 短时间过负荷 Short-time overload | 加载 2.5 倍的额定电压，时间 5 秒后测量试验前后的阻值变化率。 Applied 2.5 times of rated voltage for 5 second. Measure the variation of resistance. $\Delta R\% = \frac{R_2 - R_1}{R_1} * 100 \text{-----} (\%)$ $R_1 = \text{试验前阻值(resistance before test)}$ $R_2 = \text{试验后阻值(resistance after test)}$ |
| 抗焊锡热 Resist to soldering heat | 沾助焊剂后浸入锡炉，锡炉温度 260±5°C，时间 10±0.5 秒，测量试验前后的阻值变化率。 Dip the terminal in a flux and then dip into a soldering bath at 260±5°C for 10±0.5sec. Measure the variation of resistance. $\Delta R\% = \frac{R_2 - R_1}{R_1} * 100 \text{-----} (\%)$ $R_1 = \text{试验前阻值(resistance before test)}$ $R_2 = \text{试验后阻值(resistance after test)}$ |

厚膜贴片电阻承认书-CR 系列

Approval Specification for Thick Film Chip Resistors - Type **CR**

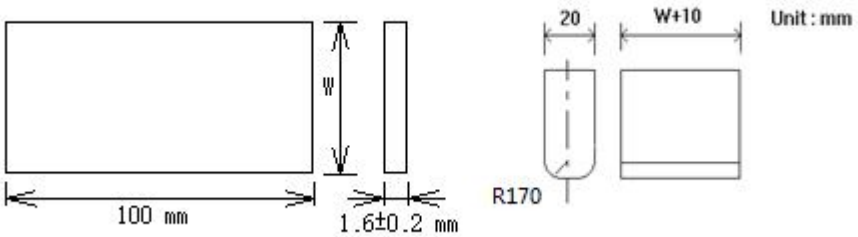
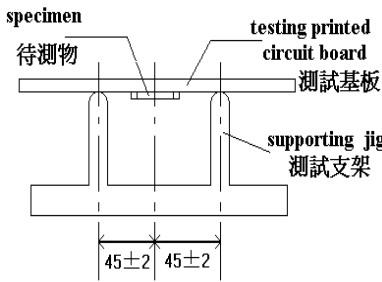
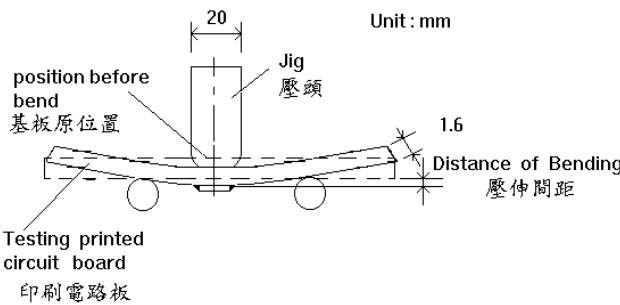
| 内容 Item | 测试条件 Test Conditions |
|--------------------------|--|
| 端子弯曲 Terminal bending | <p>电阻焊接在测试板上进行弯折,弯折保持时间 20±1 秒, 1206(含) 以下的尺寸弯曲 $5^{+0.2}/\%$mm; 1206 以上的尺寸弯曲 $2^{+0.2}/\%$mm; 量测试验前后阻值变化率</p> <p>Specimen shall be mounted on test board, then bend the board and maintained for 20±1s. the distance of bending is $5^{+0.2}/\%$mm for resistors which size no larger than 1206 or $2^{+0.2}/\%$mm which size larger than 1206. Measure the variation of resistance.</p> <p>测试板 (test board) 压头 (jig)</p>    $\Delta R\% = \frac{R_2 - R_1}{R_1} * 100 \text{-----} (\%)$ <p>R1 = 试验前阻值(resistance before test) R2 = 试验后阻值(resistance after test)</p> |

厚膜贴片电阻承认书-CR 系列

Approval Specification for Thick Film Chip Resistors - Type **CR**

| 内容 Item | 测试条件 Test Conditions |
|-----------------------------|---|
| 负荷寿命 Load life | <p>电阻放入恒温箱中，温度 70±2℃，通电额定电压 1000⁺²⁴/0 小时，量测试验前后阻值变化率。</p> <p>Put the specimen in a chamber at 70±2℃ temperature, and applied rated voltage for 1000⁺²⁴/0H. Measure the variation of resistance.</p> $\Delta R\% = \frac{R_2 - R_1}{R_1} * 100 \text{-----} (\%)$ <p>R1 = 试验前阻值(resistance before test) R2 = 试验后阻值(resistance after test)</p> |
| 耐湿特性 Humidity | <p>电阻放入恒温恒湿箱，温度 40±2℃，湿度 90~95 %RH;通电额定电压 1.5 小时，断电 0.5 小时；重复通断电至试验时间 1000⁺⁴⁸/0 小时。量测试验前后阻值变化率。</p> <p>Put the specimen in a chamber at 40±2℃ temperature and 90~95% relative humidity, then applied rated voltage for 1.5H and rested for 0.5H repeatedly till total test time is 1000⁺⁴⁸/0.. Measure the variation of resistance.</p> $\Delta R\% = \frac{R_2 - R_1}{R_1} * 100 \text{-----} (\%)$ <p>R1 = 试验前阻值(resistance before test) R2 = 试验后阻值(resistance after test)</p> |
| 温度循环 Temperature Cycling | <p>电阻放入温度循环机中，温度 155±2℃至-55±3℃，共 5 个循环。量测试验前后阻值变化率。</p> <p>Put specimen in a chamber which temperature can be changed to 125±2℃ or -55±3℃, repeated 5 times. Measure the variation of resistance.</p> $\Delta R\% = \frac{R_2 - R_1}{R_1} * 100 \text{-----} (\%)$ <p>R1 = 试验前阻值(resistance before test) R2 = 试验后阻值(resistance after test)</p> |

厚膜贴片电阻承认书-CR 系列

Approval Specification for Thick Film Chip Resistors - Type **CR**

| 内容 Item | 测试条件 Test Conditions | | | | | | | | | | | | | | | | | | | | | | | | | | | | | | | | | | | | | | | | | | | | | | | | |
|-----------------------------|---|------------------------|------------------------------------|----------------------------------|----------------------------------|-------|-------|-----------------|--------|--------|--------|--------|--------|-------------------|----------------------------------|-----|----------------------------------|----------------------------------|-----|------------|------|----|------|------|----|------------------------|-------|-------|-------|-------|--------|-----------------|--------|--------|--------|--------|--------|-------------------|----------------------------------|-----|------------------------------------|------|----------------------------------|------------|------|----|------|----|------|
| 温湿循环 Moisture Resistance | <p>电阻放入恒温恒湿箱，加载额定电压，温湿度条件如下表；循环测试 42 次，测试时间 1000 小时。量测试验前后阻值变化率。</p> <p>Put specimen in a chamber and applied rated voltage. Temperature and humidity conditions as following. There are 42 cycles and total test time is 1000H. Measure the variation of resistance.</p> <p style="text-align: center;">表 1 (table1)</p> <table border="1" style="width: 100%; border-collapse: collapse; margin-bottom: 10px;"> <thead> <tr> <th style="width: 15%;">测试条件 test condition</th> <th style="width: 15%;">step1</th> <th style="width: 15%;">step2</th> <th style="width: 15%;">step3</th> <th style="width: 15%;">step4</th> <th style="width: 15%;">step5</th> </tr> </thead> <tbody> <tr> <td>湿度% humidity</td> <td>90~96%</td> <td>90~96%</td> <td>80~96%</td> <td>90~96%</td> <td>90~96%</td> </tr> <tr> <td>温度 temperature</td> <td>升温至 65℃ increase to 65℃</td> <td>65℃</td> <td>降温至 25℃ decrease to 25℃</td> <td>升温至 65℃ increase to 65℃</td> <td>65℃</td> </tr> <tr> <td>时间 time</td> <td>2.5H</td> <td>3H</td> <td>2.5H</td> <td>2.5H</td> <td>3H</td> </tr> </tbody> </table> <table border="1" style="width: 100%; border-collapse: collapse; margin-bottom: 10px;"> <thead> <tr> <th style="width: 15%;">测试条件 test condition</th> <th style="width: 15%;">step6</th> <th style="width: 15%;">step7</th> <th style="width: 15%;">step8</th> <th style="width: 15%;">step9</th> <th style="width: 15%;">step10</th> </tr> </thead> <tbody> <tr> <td>湿度% humidity</td> <td>80~96%</td> <td>90~96%</td> <td>90~96%</td> <td>90~96%</td> <td>90~96%</td> </tr> <tr> <td>温度 temperature</td> <td>降温至 25℃ decrease to 25℃</td> <td>25℃</td> <td>降温至 -10℃ decrease to -10℃</td> <td>-10℃</td> <td>升温至 25℃ increase to 25℃</td> </tr> <tr> <td>时间 time</td> <td>2.5H</td> <td>2H</td> <td>0.5H</td> <td>3H</td> <td>0.5H</td> </tr> </tbody> </table> <p style="text-align: center;"> $\Delta R\% = \frac{R_2 - R_1}{R_1} * 100 \text{-----} (\%)$ </p> <p style="text-align: center;"> R1 = 试验前阻值(resistance before test) R2 = 试验后阻值(resistance after test) </p> | 测试条件 test condition | step1 | step2 | step3 | step4 | step5 | 湿度% humidity | 90~96% | 90~96% | 80~96% | 90~96% | 90~96% | 温度 temperature | 升温至 65℃ increase to 65℃ | 65℃ | 降温至 25℃ decrease to 25℃ | 升温至 65℃ increase to 65℃ | 65℃ | 时间 time | 2.5H | 3H | 2.5H | 2.5H | 3H | 测试条件 test condition | step6 | step7 | step8 | step9 | step10 | 湿度% humidity | 80~96% | 90~96% | 90~96% | 90~96% | 90~96% | 温度 temperature | 降温至 25℃ decrease to 25℃ | 25℃ | 降温至 -10℃ decrease to -10℃ | -10℃ | 升温至 25℃ increase to 25℃ | 时间 time | 2.5H | 2H | 0.5H | 3H | 0.5H |
| 测试条件 test condition | step1 | step2 | step3 | step4 | step5 | | | | | | | | | | | | | | | | | | | | | | | | | | | | | | | | | | | | | | | | | | | | |
| 湿度% humidity | 90~96% | 90~96% | 80~96% | 90~96% | 90~96% | | | | | | | | | | | | | | | | | | | | | | | | | | | | | | | | | | | | | | | | | | | | |
| 温度 temperature | 升温至 65℃ increase to 65℃ | 65℃ | 降温至 25℃ decrease to 25℃ | 升温至 65℃ increase to 65℃ | 65℃ | | | | | | | | | | | | | | | | | | | | | | | | | | | | | | | | | | | | | | | | | | | | |
| 时间 time | 2.5H | 3H | 2.5H | 2.5H | 3H | | | | | | | | | | | | | | | | | | | | | | | | | | | | | | | | | | | | | | | | | | | | |
| 测试条件 test condition | step6 | step7 | step8 | step9 | step10 | | | | | | | | | | | | | | | | | | | | | | | | | | | | | | | | | | | | | | | | | | | | |
| 湿度% humidity | 80~96% | 90~96% | 90~96% | 90~96% | 90~96% | | | | | | | | | | | | | | | | | | | | | | | | | | | | | | | | | | | | | | | | | | | | |
| 温度 temperature | 降温至 25℃ decrease to 25℃ | 25℃ | 降温至 -10℃ decrease to -10℃ | -10℃ | 升温至 25℃ increase to 25℃ | | | | | | | | | | | | | | | | | | | | | | | | | | | | | | | | | | | | | | | | | | | | |
| 时间 time | 2.5H | 2H | 0.5H | 3H | 0.5H | | | | | | | | | | | | | | | | | | | | | | | | | | | | | | | | | | | | | | | | | | | | |

Approval Specification for Thick Film Chip Resistors - Type **CR**

12. 上胶带剥离力测试 (Peel force of top cover tape)

上胶带以 200mm/分钟的速度，沿 165~180 度角的方向进行剥离，如下图所示。纸带的剥离力范围为 10g~70g；载带的剥离力范围为 30~100g

The top cover tape is pulled at a speed of 200 mm/min with the angle between the tape during peel and the direction of unreeling maintained at 165 to 180 degree as following picture. The peel force of paper carrier tape shall be 0.1N to 0.7N(10 to 70 g), the peel force of plastic carrier tape shall be 0.3N to 1N (30 to 100 g)

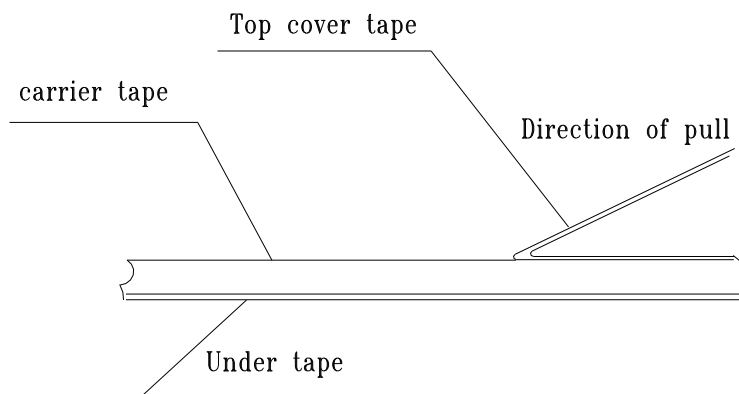

13. 焊盘尺寸 (Recommended land patterns):

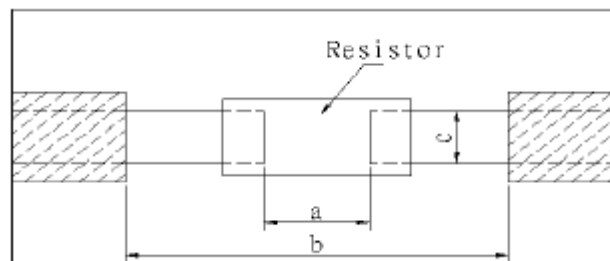

| Type | Land pattern | Dimensions (mm) | | |
|------|--------------|-----------------|---------|---------|
| | | a | b | c |
| | CR0201 | 0.25~0.3 | 0.7~0.9 | 0.3~0.4 |
| | CR0402 | 0.5~0.6 | 1.4~1.6 | 0.4~0.6 |
| | CR0603 | 0.7~0.9 | 2.0~2.2 | 0.8~1.0 |
| | CR0805 | 1.0~1.4 | 3.2~3.8 | 0.9~1.4 |
| | CR1206 | 2.0~2.4 | 4.4~5.0 | 1.2~1.8 |
| | CR1210 | 2.0~2.4 | 4.4~5.0 | 2.3~3.5 |
| | CR1812 | 2.8~3.2 | 7.6~8.6 | 2.3~3.5 |
| | CR2010 | 3.3~3.7 | 5.7~6.5 | 2.3~3.5 |
| | CR2512 | 3.6~4.0 | 7.6~8.6 | 2.3~3.5 |

Approval Specification for Thick Film Chip Resistors - Type CR

14. 焊接 (soldering)

14.1 建议回流焊曲线 (Recommend reflow soldering profile)

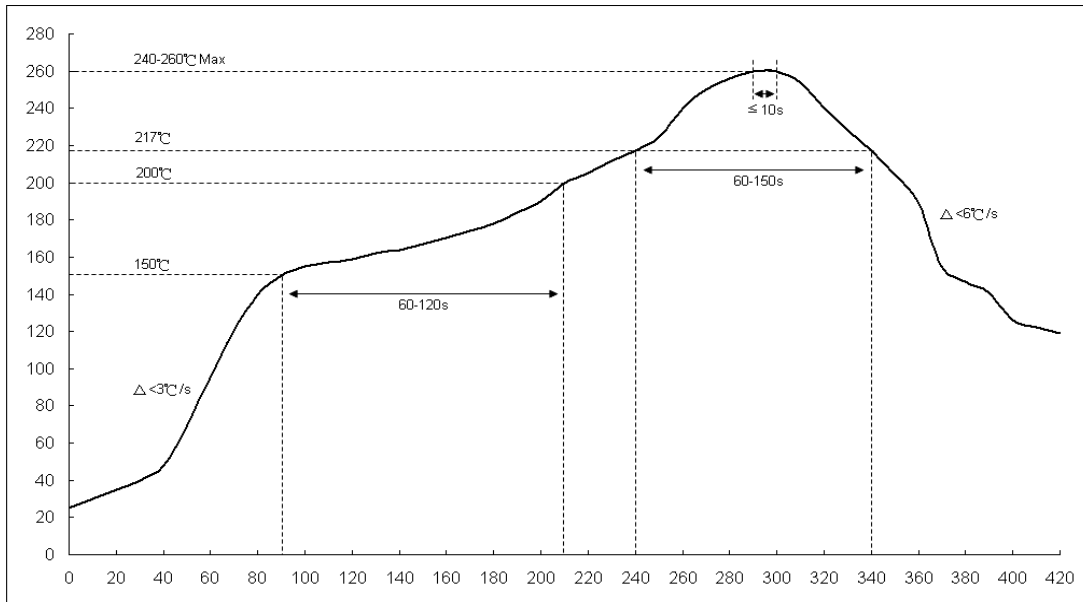

14.2 建议波峰焊曲线 (Recommend wave soldering profile)

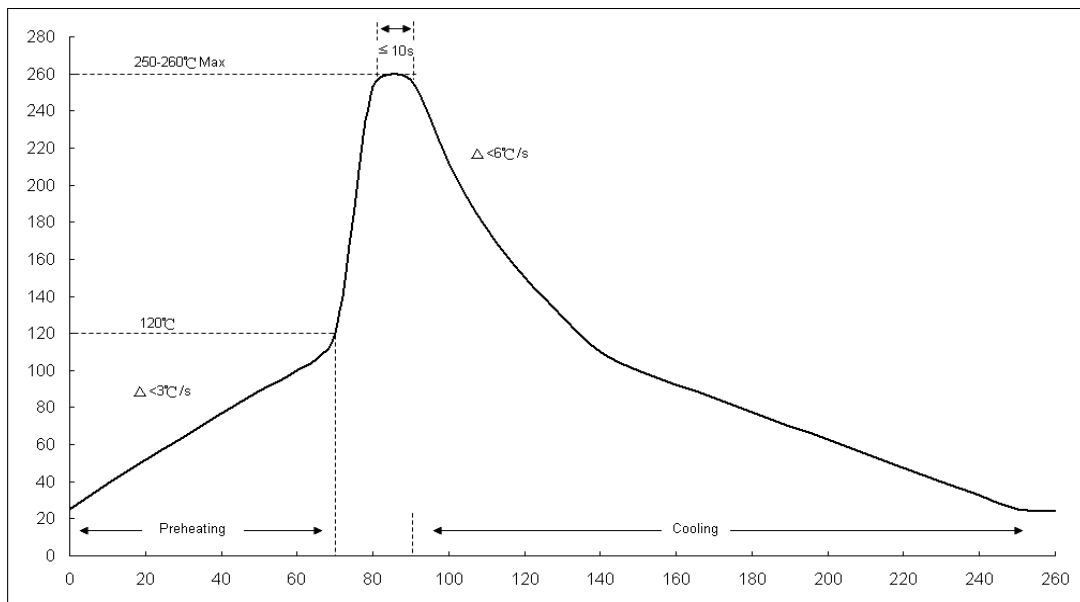

14.3 手工焊温度 (hand soldering temperature)

烙鐵溫度 $350 \pm 10^\circ\text{C}$ 3 秒之內，避免烙鐵接觸電阻本體

The iron temperature is $350 \pm 10^\circ\text{C}$, hand soldering time less than 3S. Avoid solder iron tip direct touch the components body.