

## Surface Mount Ultra Fast Recovery Rectifier

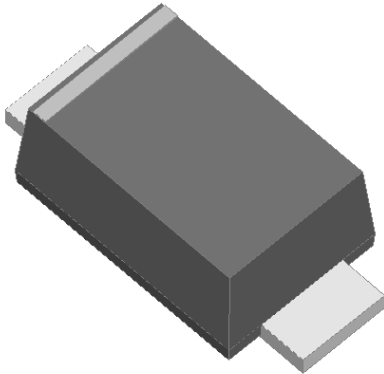

### Features

- Low profile package
- Ideal for automated placement
- Glass passivated chip junction
- High forward surge capability
- Super Fast reverse recovery time
- Meets MSL level 1, per J-STD-020, LF maximum peak of 260 °C

### Typical Applications

For use in high frequency rectification of power supplies, inverters, converters, and freewheeling diodes for consumer and telecommunication.

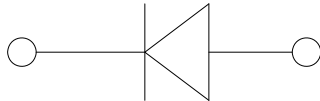

### Mechanical Data

- **Package:** SOD-123FL  
Molding compound meets UL 94 V-0 flammability rating, RoHS-compliant, halogen-free
- **Terminals:** Tin plated leads, solderable per J-STD-002 and JESD22-B102
- **Polarity:** Cathode line denotes the cathode end

### ■ Maximum Ratings (T<sub>a</sub>=25°C Unless otherwise specified)

PARAMETER	SYMBOL	UNIT	U1A	U1B	U1C	U1D	U1F	U1G	U1H	U1J
Device marking code			U1A	U1B	U1C	U1D	U1F	U1G	U1H	U1J
Repetitive peak reverse voltage	VRRM	V	50	100	150	200	300	400	500	600
Average rectified output current @60Hz sine wave, Resistance load, TL (FIG.1)	I <sub>O</sub>	A	1.0							
Surge(non-repetitive)forward current @ 60Hz Half-sine wave,1 cycle, T <sub>a</sub> =25°C	I <sub>FSM</sub>	A	30							
Storage temperature	T <sub>stg</sub>	°C	-55~+150							
Junction temperature	T <sub>j</sub>	°C	-55 ~ +150							

### ■ Electrical Characteristics (T<sub>a</sub>=25°C Unless otherwise specified)

PARAMETER	SYMBOL	UNIT	TEST CONDITIONS	U1A	U1B	U1C	U1D	U1F	U1G	U1H	U1J
Maximum instantaneous forward voltage drop per diode	V <sub>F</sub>	V	I <sub>FM</sub> =1.0A	0.92			1.25		1.7		
Maximum reverse recovery time	TRR	ns	I <sub>F</sub> =0.5A, I <sub>R</sub> =1.0A, I <sub>tr</sub> =0.25A	25						35	
Maximum DC reverse current at rated DC blocking voltage per diode @ VRM=VRRM	I <sub>RRM</sub>	μA	T <sub>a</sub> =25°C	5							
			T <sub>a</sub> =100°C	50							



# U1A THRU U1J

## ■ Thermal Characteristics (Ta=25°C Unless otherwise specified)

PARAMETER	SYMBOL	UNIT	U1A	U1B	U1C	U1D	U1F	U1G	U1H	U1J
Typical Thermal resistance	R $\theta$ J-A <sup>(1)</sup>	°C/W	65 <sup>(1)</sup>							
	R $\theta$ J-L <sup>(1)</sup>		22 <sup>(1)</sup>							

Note:  
 (1) Thermal resistance between junction and ambient and between junction and lead mounted on P.C.B with 3mm\*3mm copper pad areas.

## ■ Characteristics (Typical)

FIG.1: I<sub>o</sub>-TL Cure

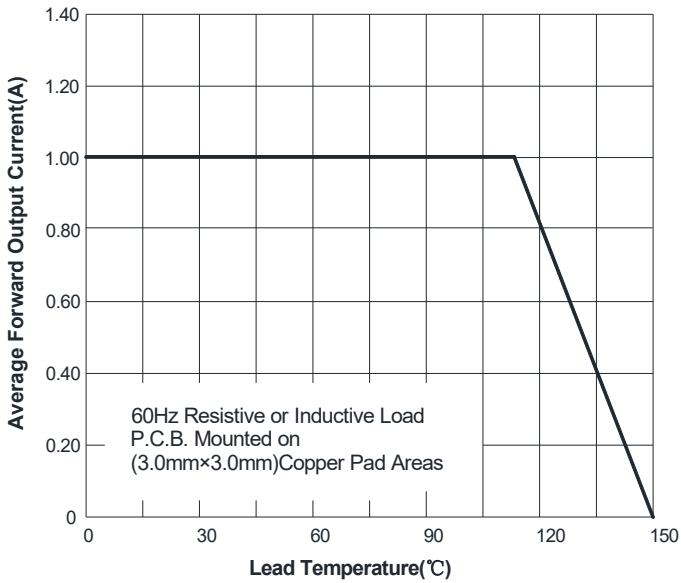

FIG.2: Forward Surge Current Capability

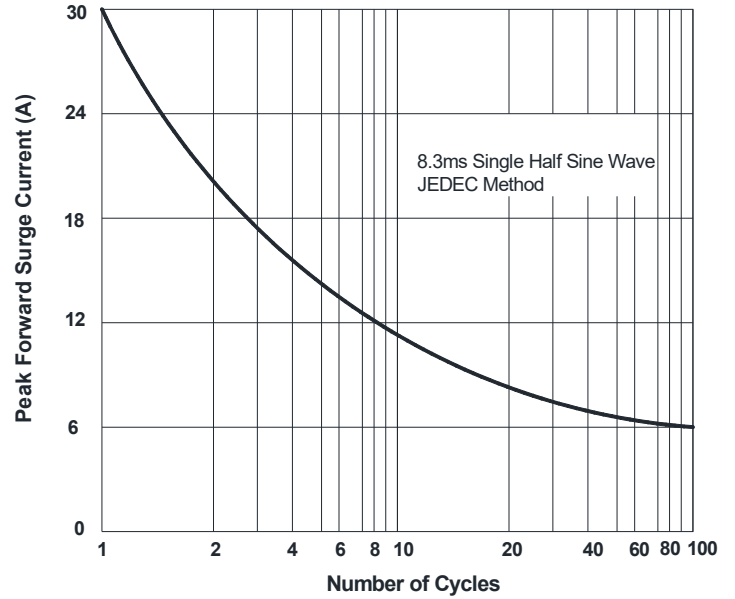

FIG.3: Typical Forward Characteristics

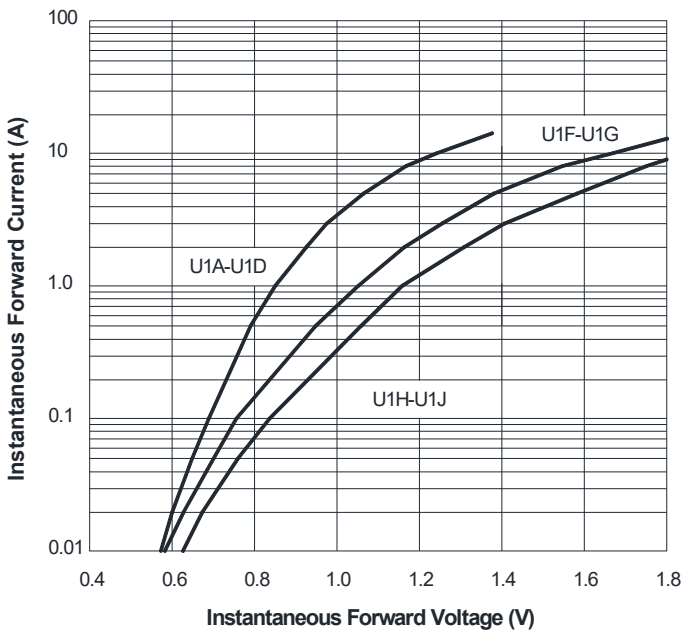
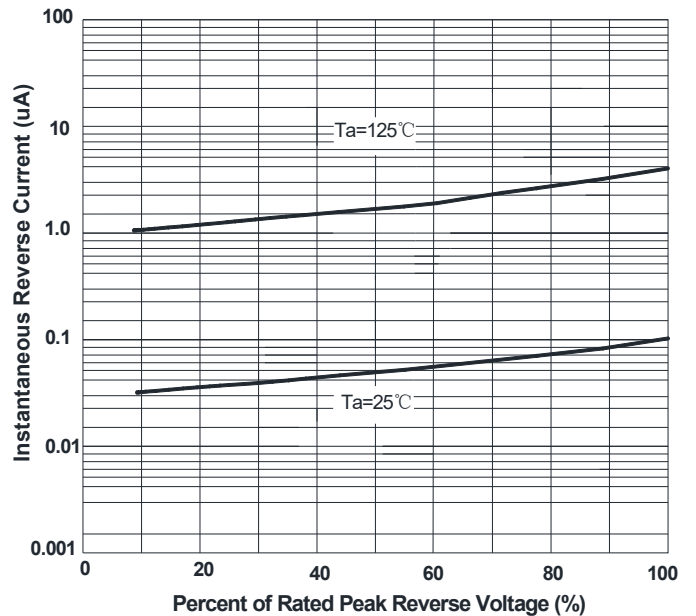

FIG.4: Typical Reverse Characteristics





# U1A THRU U1J

FIG.5: Diagram of circuit and Testing wave form of reverse recovery time

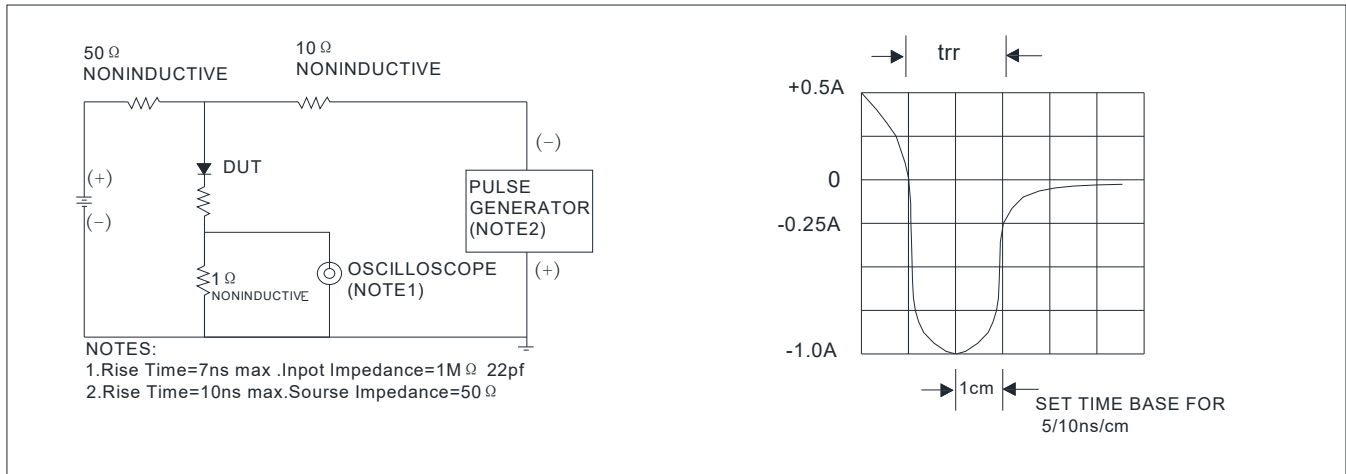

## Ordering Information (Example)

PREFERRED P/N	PACKING CODE	UNIT WEIGHT(g)	MINIMUM PACKAGE(pcs)	INNER BOX QUANTITY(pcs)	OUTER CARTON QUANTITY(pcs)	DELIVERY MODE
U1A THRU U1J	F1	Approximate 0.0169	3000	15000	120000	7" reel
U1A THRU U1J	F2	Approximate 0.0169	2500	12500	100000	7" reel
U1A THRU U1J	F3	Approximate 0.0169	10000	30000	210000	13" reel
U1A THRU U1J	F4	Approximate 0.0169	3000	27000	108000	7" reel
U1A THRU U1J	F5	Approximate 0.0169	10000	20000	160000	13" reel
U1A THRU U1J	F6	Approximate 0.0169	3000	12000	60000	7" reel

## Outline Dimensions

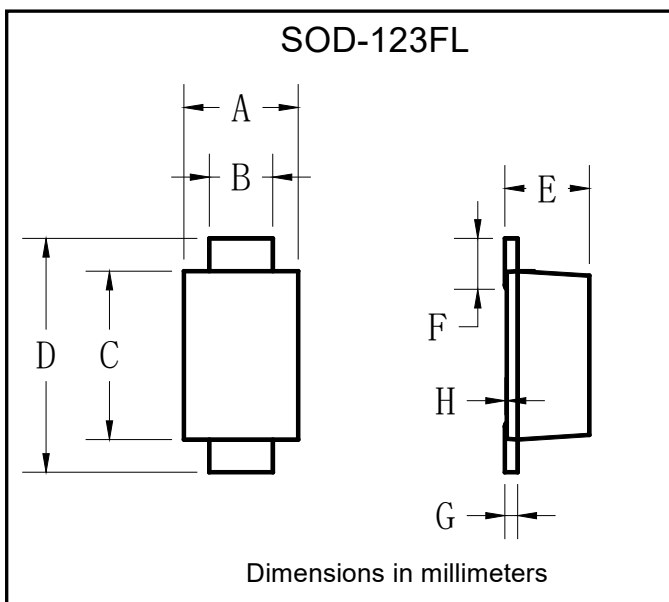

SOD-123FL		
Dim	Min	Max
A	1.60	1.90
B	0.90	1.10
C	2.55	2.85
D	3.60	3.90
E	1.00	1.20
F	0.40	0.90
G	0.10	0.25
H	0.02	0.05



## U1A THRU U1J

### ■ Suggested pad layout

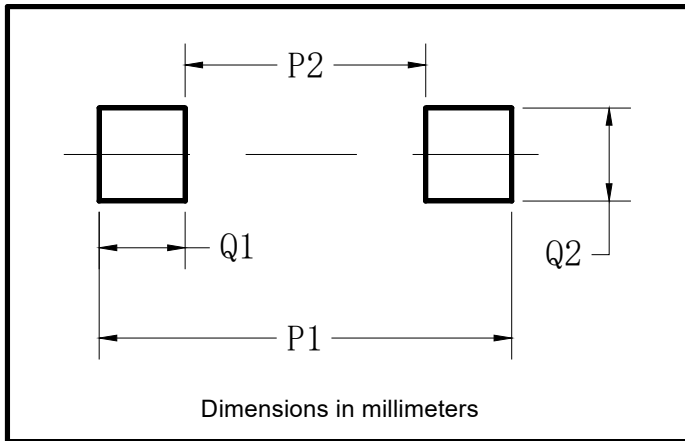

SOD-123FL	
Dim	Millimeters
P1	3.90
P2	1.90
Q1	1.00
Q2	1.50



## U1A THRU U1J

---

### Disclaimer

The information presented in this document is for reference only. Yangzhou Yangjie Electronic Technology Co., Ltd. reserves the right to make changes without notice for the specification of the products displayed herein to improve reliability, function or design or otherwise.

The product listed herein is designed to be used with ordinary electronic equipment or devices, and not designed to be used with equipment or devices which require high level of reliability and the malfunction of which would directly endanger human life (such as medical instruments, transportation equipment, aerospace machinery, nuclear-reactor controllers, fuel controllers and other safety devices), Yangjie or anyone on its behalf, assumes no responsibility or liability for any damages resulting from such improper use of sale.

This publication supersedes & replaces all information previously supplied. For additional information, please visit our website [http:// www.21yangjie.com](http://www.21yangjie.com) , or consult your nearest Yangjie's sales office for further assistance.