



Glass Passivated Rectifier Diode Modules

VRRM 800 to 1800V
IFAV 240 A

Applications

- Non-controllable rectifiers for AC/AC converters
- Line rectifiers for transistorized AC motor controllers
- Field supply for DC motors

Features

- Blocking voltage:800 to 1800V
- Heat transfer through aluminum oxide ceramic isolated metal baseplate
- Glass passivated chip

Circuit

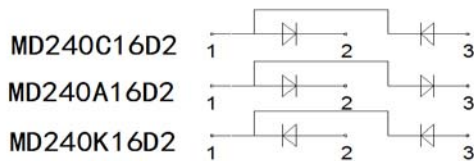

Module Type

TYPE			VRRM	VRSM
MD240C08D2	MD240A08D2	MD240K08D2	800V	900V
MD240C12D2	MD240A12D2	MD240K12D2	1200V	1300V
MD240C16D2	MD240A16D2	MD240K16D2	1600V	1700V
MD240C18D2	MD240A18D2	MD240K18D2	1800V	1900V

Maximum Ratings

Symbol	Conditions	Values	Units
IFAV	Single phase ,half wave 180° conduction Tc=95°C	240	A
IFSM	t=10mS Tvj =45°C	7550	A
i ² t	t=10mS Tvj =45°C	285000	A ² s
V _{isol}	a.c.50HZ;r.m.s.;1min	3000	V
Tvj		-40 to 150	°C
Tstg		-40 to 125	°C
Mt	To terminals(M6)	5±15%	Nm
Ms	To heat sink(M6)	5±15%	Nm
Weight	Module (Approximately)	160	g

Thermal Characteristics

Symbol	Conditions	Values	Units
R _{th(j-c)}	Per diode	0.16	°C/W
R _{th(c-s)}	Module	0.05	°C/W



Electrical Characteristics

Symbol	Conditions	Values			Units
		Min.	Typ.	Max.	
V _{FM}	T=25°C I _F =300A	—	1.15	1.25	V
I _{RD}	T _{vj} =150°C V _{RD} =V _{RRM}	—	—	9	mA
r _F	T _J =25°C	-	1.16	-	mΩ
	T _J =150°C	-	1.17	-	mΩ
V _{FO}	T _J =25°C	-	0.79	-	V
	T _J =150°C	-	0.67	-	V

Performance Curves

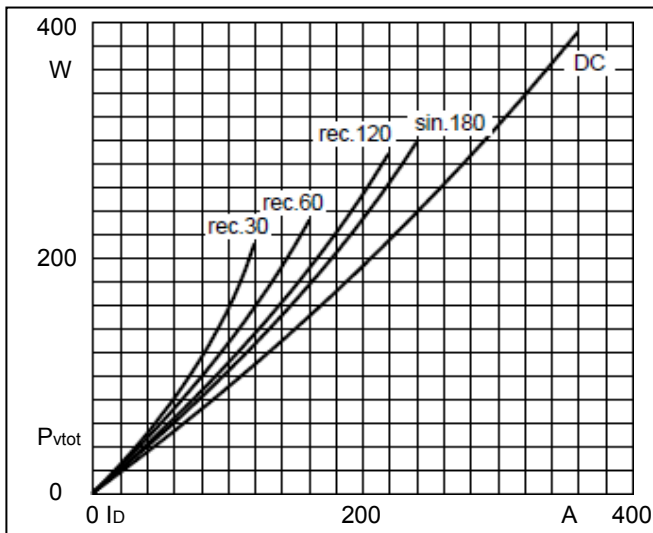

Fig1. Power dissipation

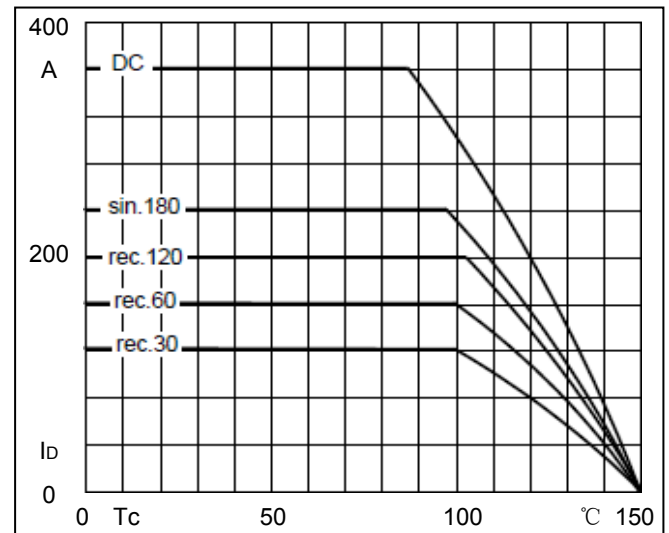

Fig2. Forward Current Derating Curve

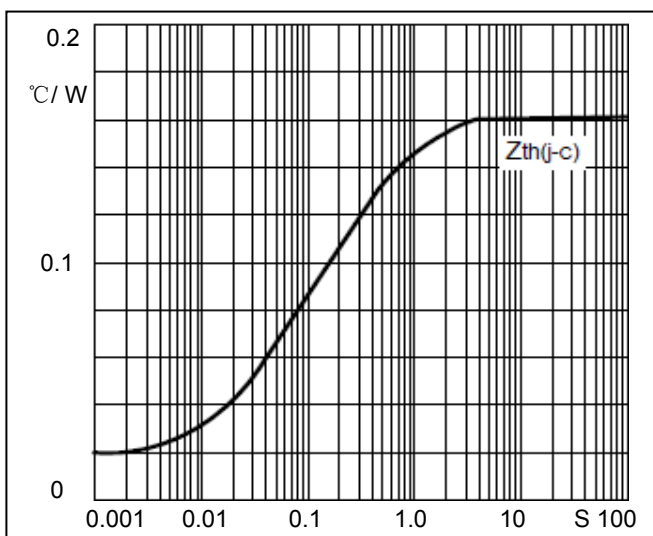

Fig3. Transient thermal impedance

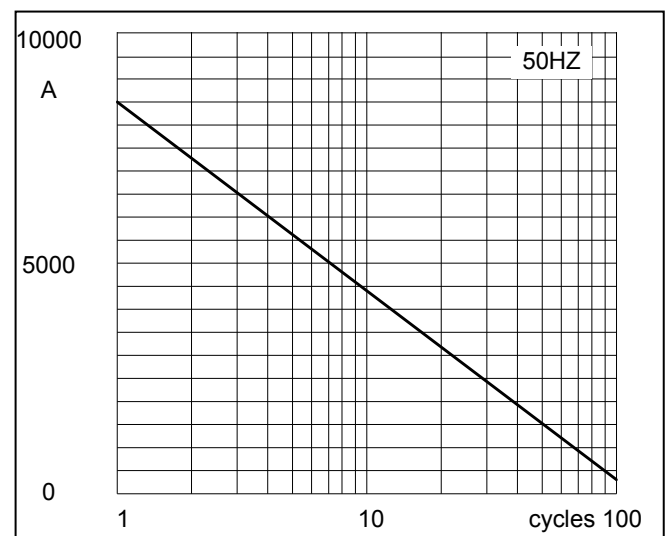

Fig4. Max Non-Repetitive Forward Surge Current

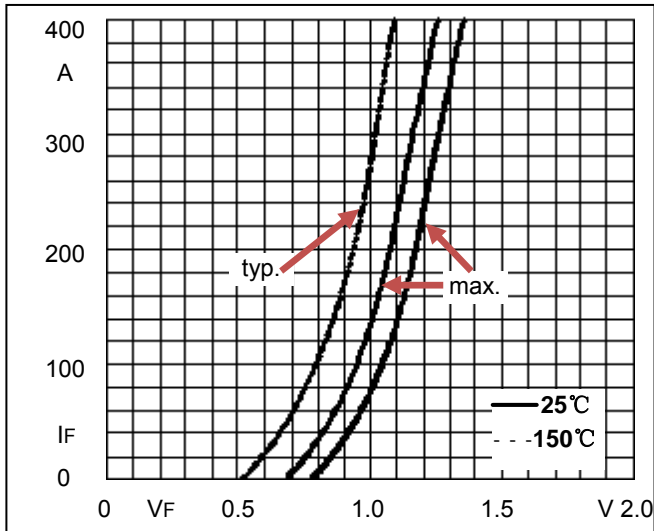
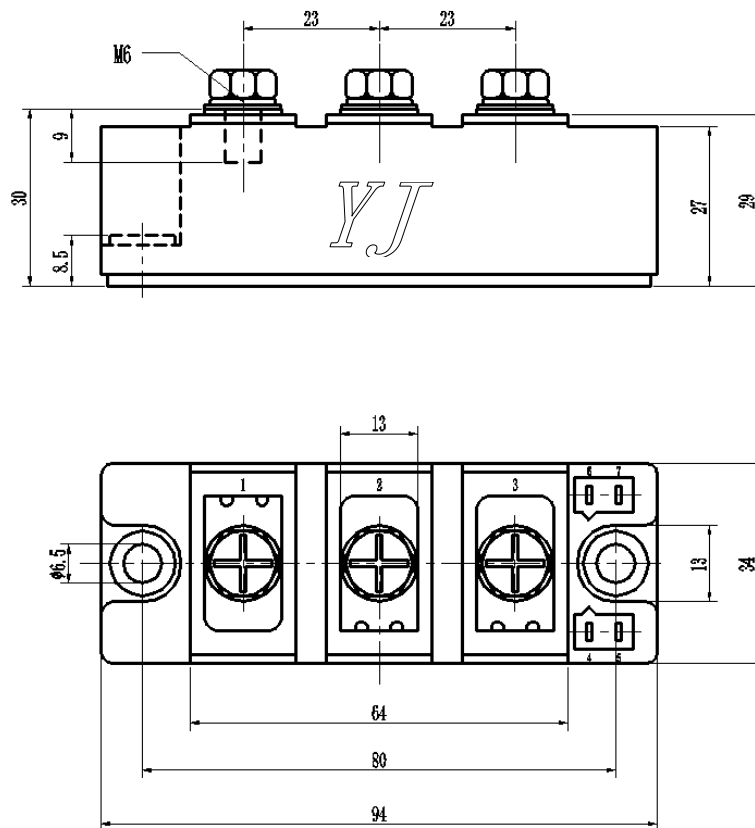

Fig5. Forward Characteristics

Package Outline Information

CASE: D2



Dimensions in mm