

CRYSTAL UNIT

32.768KHZ

YT-26 DIP



Applications

- RTC

Features

- Dimensions: 2.0 x 6.0 mm.
- Resistance welded type crystal units.
- Standard Frequency: 32.768KHz.
- Low impedance performance.



Specifications

Standard Frequency	32.768 KHz
Load Capacitance	12.5pF, or specify
Frequency Tolerance (at 25 °C)	±5ppm, ±10ppm, or specify
Parabolic Coefficient	$(-0.036 \pm 0.01) * 10^{-6} / ^\circ\text{C}^2$
Frequency Versus Temperature Characteristics	0~ -120ppm, or specify
Operating Temperature	-20~+70°C, -40~+85°C, or specify
Storage Temperature	-55~+125°C
Shunt Capacitance	2.0pF Max.
Level of Drive	1.0µW Typ
Aging (at 25 °C)	±3ppm/year Max.
Equivalent Series Resistance(ESR)	40K Ω Max.

Dimensions and Patterns [unit:mm]

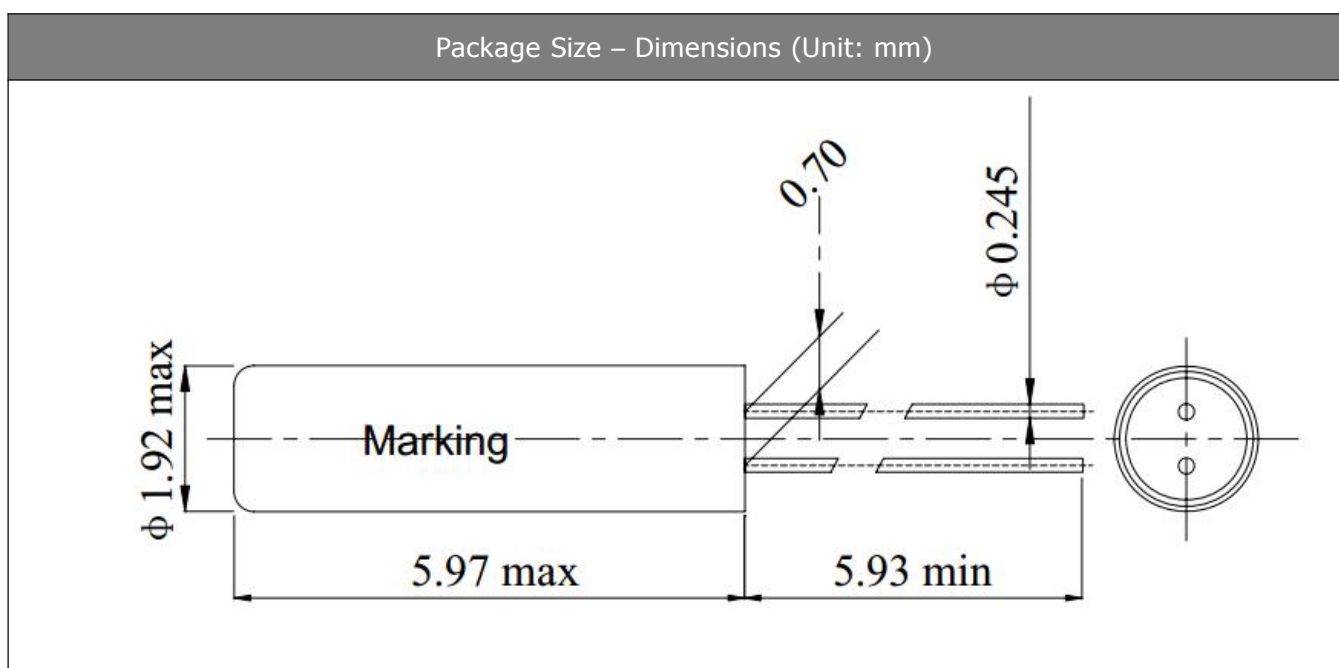

CRYSTAL UNIT

32.768KHZ

YT-26 DIP



Attention:

Not recommended reflow furnace welding, if it is to be used, the maximum temperature shall not exceed 230°C.

Handling Notice for Standard Tuning Fork Crystal (Cylindrical Type)

1. Shock resistance

It may deteriorate the characteristics or cause of no oscillation if excess physical shock given. Please be careful not to drop. Please use under condition to minimize the shocks as much as possible.

Please review the conditions if it is used by auto mounting or after the conditions are changed.

2. Heat and humidity resistance in storage

Storing the crystal products under higher or lower temperature or high humidity for a long period may deteriorate the characteristics of crystal units.

Please store and use the crystal products at the normal temperature and humidity.

3. Solder heat resistance

Standard type crystal products use Material have a 230°C melting point.

Heating up the package more than 230°C may deteriorate the characteristics or cause of no oscillation the products. If the crystal products need to be soldered at temperature of more than +230°C, please study heat-resistance products or SMD products.

Please review the condition or consult us about flow solder process.

Our soldering condition is under 280°C within 3sec or 320°C within 2sec for lead parts use the soldering iron. Please don't solder the crystal unit (case) directly. It may cause of deteriorate the characteristics.

4. Mounting method to PCB

When the crystal products need to be lay down please fix to PCB securely. If the crystal is used with mechanical vibration location, please put cushion in between PCB or fix with elasticity glue (Silicon etc) as shown in below figure.

Please don't gluing hermetic seal glass. When the crystal products need to be mounted vertically, gap between crystal units and PCB more than 3mm for 3×8 type, more than 2mm for 2×6 type is recommended.

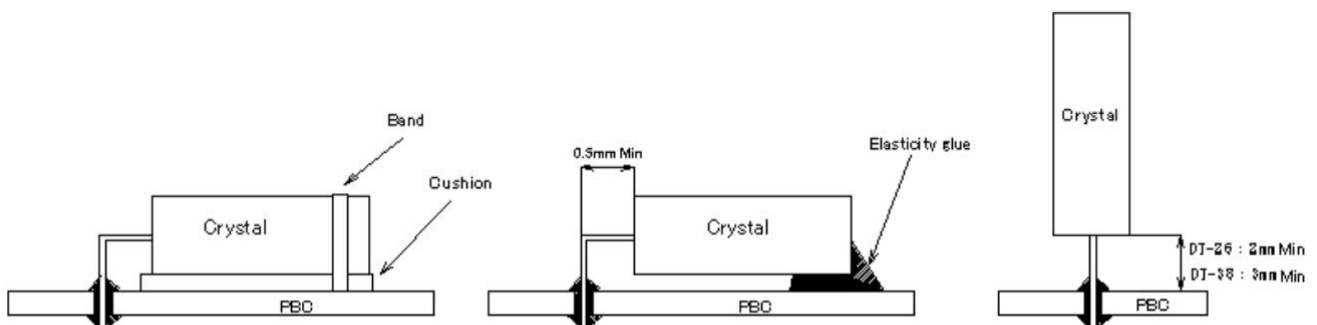

5. Lead process

When the lead needs to be cut please maintenance the cutter.

When the lead needs to be bent or repaired please be careful not to giving excess pressure at the root of the lead to avoid crack of the hermetic seal glass. Also please be careful not to giving excess pressure at sealing to avoid sealing tightness deteriorate.

Leave more than 0.5 mm of lead from the case.

CRYSTAL UNIT

32.768KHZ

YT-26 DIP



6. Ultrasonic cleaning and ultrasonic soldering

Soldered by ultrasonic cannot be guaranteed, because crystal may be sympathetic vibrated and may damage. Please study at your side about ultrasonic cleaning.

7. Drive level

Applying excessive drive level to the crystal units may cause deterioration of characteristics or damage. Less than 1.0μW is recommended to this products. More than 2.0μW cannot be guaranteed.