

**■ Features**

- Low profile construction and miniature size.
- Magnetic shielded construction.
- High current saturation.
- Operating temperature:-40°C ~ +125°C.
- RoHS compliant

**■ Applications**

- For small DC/DC converter(HDD,DVC,DSC,PDA,LCD display etc.).
- Car navigation systems,telecom base stations.
- VR,AR,LED lighting.

**■ Product Identification**



(1) : Type

(2) : Dimensions

(3) : Inductance value

(4) : Inductance Tolerance; N=±30%,M=±20%, K=±10%

**■ Shapes and Dimensions (Unit: mm)**

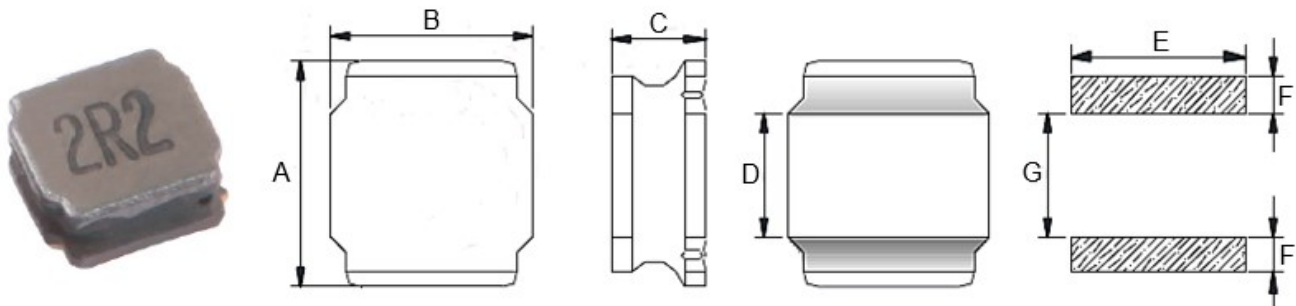

TYPE	A	B	C Max.	D	E Ref.	F Ref.	G Ref.
YNR5040	5.0±0.2	5.0±0.2	4.00	1.25±0.2	4.70	1.40	2.30

## ■ YNR5040 Series

Part Number	Inductance (uH) @100KHz	DC Resistance ( $\Omega$ )		Heat Rating Current (A)	Saturation Current (A)
		Typ.	Max.		
YNR5040-R22□	0.22	0.006	0.008	6.500	18.000
YNR5040-R24□	0.24	0.006	0.008	6.400	15.700
YNR5040-R47□	0.47	0.007	0.009	6.600	10.000
YNR5040-1R0□	1.00	0.012	0.016	4.900	7.350
YNR5040-1R5□	1.50	0.015	0.020	4.300	6.300
YNR5040-1R8□	1.80	0.016	0.021	4.150	5.500
YNR5040-2R2□	2.20	0.019	0.025	3.800	4.900
YNR5040-2R7□	2.70	0.022	0.029	3.600	4.300
YNR5040-3R0□	3.00	0.022	0.029	3.600	4.150
YNR5040-3R3□	3.30	0.024	0.031	3.400	3.950
YNR5040-3R6□	3.60	0.026	0.034	3.300	3.800
YNR5040-3R9□	3.90	0.027	0.035	3.200	3.550
YNR5040-4R7□	4.70	0.030	0.039	3.000	3.500
YNR5040-5R6□	5.60	0.035	0.046	2.800	3.000
YNR5040-6R8□	6.80	0.043	0.056	2.500	2.900
YNR5040-8R2□	8.20	0.048	0.062	2.300	2.700
YNR5040-100□	10.0	0.064	0.083	2.100	2.350
YNR5040-120□	12.0	0.077	0.100	2.000	2.200
YNR5040-150□	15.0	0.086	0.112	2.000	2.000
YNR5040-180□	18.0	0.119	0.155	1.450	1.700
YNR5040-220□	22.0	0.129	0.168	1.500	1.600
YNR5040-270□	27.0	0.188	0.244	1.100	1.520
YNR5040-330□	33.0	0.188	0.244	1.200	1.300
YNR5040-470□	47.0	0.272	0.354	1.000	1.100

## ■ YNR5040 Series

Part Number	Inductance (uH) @100KHz	DC Resistance ( $\Omega$ )		Heat Rating Current (A)	Saturation Current (A)
		Typ.	Max.		
YNR5040-510□	51.0	0.380	0.494	1.000	1.000
YNR5040-560□	56.0	0.380	0.494	0.800	1.050
YNR5040-680□	68.0	0.400	0.520	0.800	0.900
YNR5040-750□	75.0	0.450	0.585	0.720	0.850
YNR5040-101□	100	0.560	0.728	0.700	0.750
YNR5040-151□	150	0.750	0.975	0.600	0.650
YNR5040-221□	220	1.400	1.820	0.400	0.480
YNR5040-331□	330	2.100	2.730	0.400	0.420
YNR5040-471□	470	3.000	3.900	0.350	0.370
YNR5040-561□	560	3.780	4.920	0.310	0.310
YNR5040-681□	680	3.900	5.070	0.25	0.300
YNR5040-102□	1000	6.000	7.800	0.200	0.210
YNR5040-152□	1500	8.140	10.582	0.190	0.200
YNR5040-202□	2000	12.300	14.760	0.140	0.170
YNR5040-282□	2800	19.000	24.700	0.105	0.150
YNR5040-332□	3300	21.000	25.200	0.100	0.140
YNR5040-392□	3900	23.500	30.550	0.100	0.125
YNR5040-472□	4700	35.000	45.500	0.080	0.110
YNR5040-562□	5600	39.000	50.70	0.080	0.105
YNR5040-682□	6800	43.000	55.900	0.075	0.090
YNR5040-822□	8200	43.000	55.900	0.075	0.070
YNR5040-103□	10000	45.000	58.500	0.075	0.065

- ※ The saturation current value is the DC current value having inductance decrease down to 30%.(at 20°C)
- ※ The temperature rise current value is the DC current value having temperature increase up to 40°C. (at 20°C)
- ※ The rated current is the DC current value that satisfies both of current value saturation current value and temperature rise current value.

**■ Taping Dimensions(Unit:mm)**

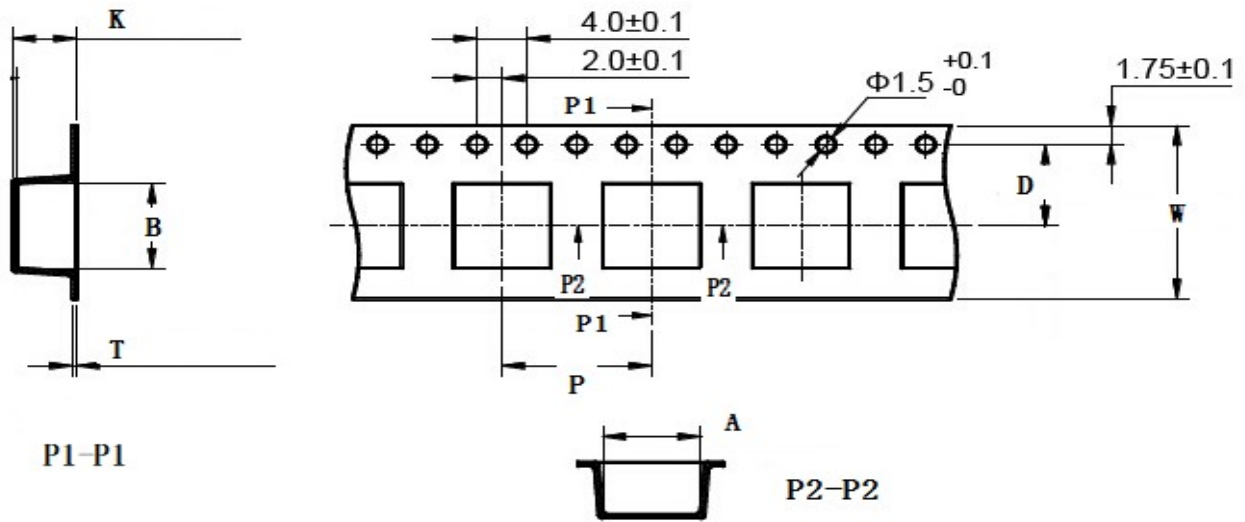

TYPE	Chip Thickness	W	A	B	D	P	K Max	T Max	MPQ
YNR5040	4.00	12.0	5.30	5.30	5.50	8.00	4.20	0.40	1500

**■ Reel Dimensions(Unit:mm)**



TYPE	W	W1	A	B	C	D
YNR5040	330±2.0	12.8±1.50	13.0±0.50	21.0±0.80	2.0±0.50	100 Min

**Direction of rolling**



**Cover tape peel off condition**



Cover tape peel force shall be 0.1N to 1.3N.

Reference peel speed  $300 \pm 10$ mm/min.