

环保物料

TEL: 0769-82001899

NOTE:

1.MATERIAL:

Housing: ThermalPlastic (UL94V-0)

Terminal: Copper Alloy

Color: Natural

2.SPECIFICATION:

Current Rating: 0.5A AC,DC (AWG#32)

Voltage Rating: 30V (AC,DC)

Contact Resistance: Initial: 30mΩ max

After environmental: 40mΩmax

Insulator Resistance:Initial: 100MΩ min

After environmental:100MΩ min

Withstanding Voltage:200v AC for 1 minute

Temperature Range: -25°C-85°C

Applicable Wire: AWG #32

Insulation O.D.: $\phi 0.38 \pm 0.02$ mm

3.Ordering Information:

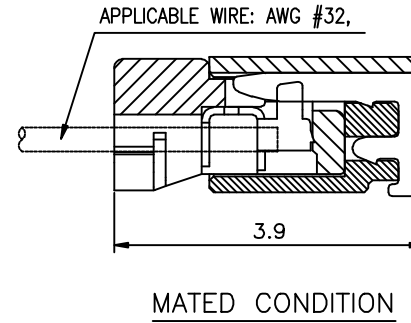
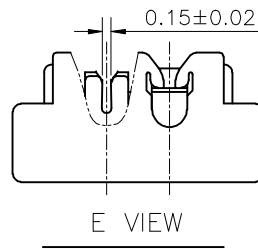
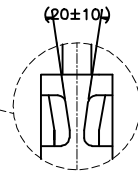
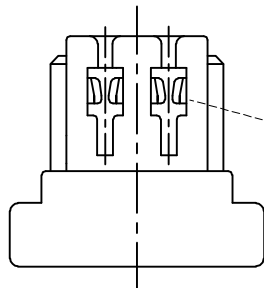
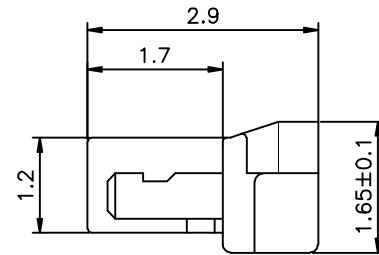
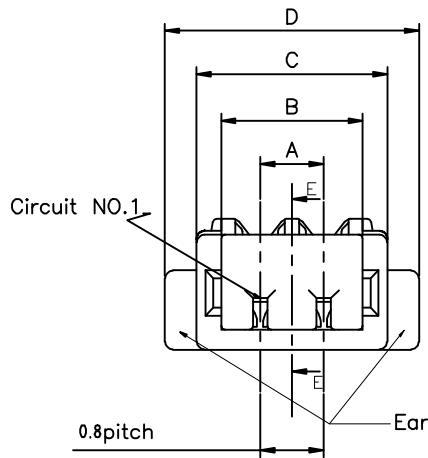

CKT	Dim A	Dim B	Dim C	Dim D
2	0.80	1.78	2.40	3.20
3	1.60	2.58	3.20	4.00
4	2.40	3.38	4.00	4.80
5	3.20	4.18	4.80	5.60
6	4.00	4.98	5.60	6.40
7	4.80	5.78	6.40	7.20
8	5.60	6.58	7.20	8.00
9	6.40	7.38	8.00	8.80
10	7.20	8.18	8.80	9.60
11	8.00	8.98	9.60	10.40
12	8.80	9.78	10.40	11.20
13	9.60	10.58	11.20	12.00
14	10.40	11.38	12.00	12.80
15	11.20	12.18	12.80	13.60
16	12.00	12.98	13.60	14.40
17	12.80	13.78	14.40	15.20
18	13.60	14.58	15.20	16.00
19	14.40	15.38	16.00	16.80
20	15.20	16.18	16.80	17.60
21	16.00	16.98	17.60	18.40
22	16.80	17.78	18.40	19.20
23	17.60	18.58	19.20	20.00
24	18.40	19.38	20.00	20.80

C-WB0812(H)-XXXXXE

C-WB0812(H)-XXXXX

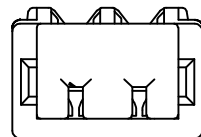
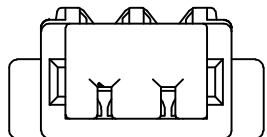

TOLERANCE UNLESS OTHERWISE

X.	±0.30	X°	±5°
.X	±0.20	.X°	±2°
.XX	±0.08	.XX°	±1°
.XXX	±0.03	.XXX°	±0.5°

DRAWN

CK tan

CHKD

APPD

VIEW



XFCN兴飞连接器有限公司
CONNECTORS XFCN CONNECTORS CO., LTD.

PRODUCT NAME

0.80mm IDC Style Connectors

PART. NO.

M0800HI-XX-GN

SHEET

1/1

DATE

2010. 4. 12

UNITS

mm

SCALE

1:1

DWG. NO.

009

AO
VER

MODIFICATION

DRAW

DATE