

HSF

Recommended P.C.B Layout(Top Side)
(PCB BOARD TOLERANCE±0.05)

NOTES:

Current Rating: 3.0AMP
 Contact Resistance: 20mΩ Max
 Withstand Voltage: 1000V AC/DC
 Insulation Resistance: 1000MΩ Min
 Operation Temperature: -40°C to +105°C

Contact Material:Brass
 Contact plating:Au Or Sn over Ni
 Insulator Material:PBT+30%G.F UL94V-0 

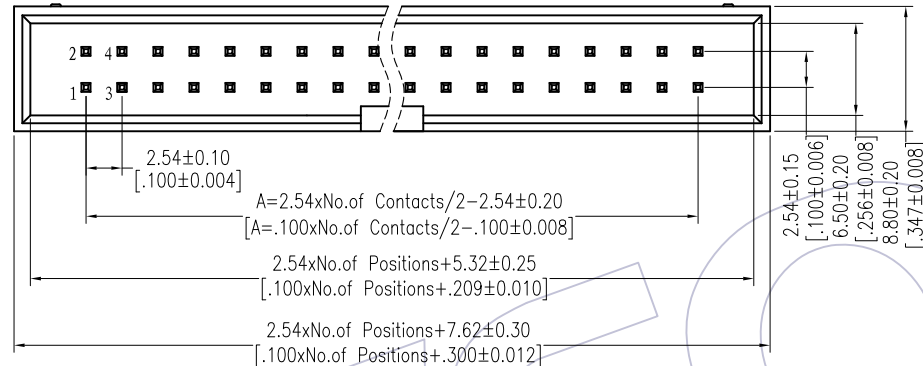
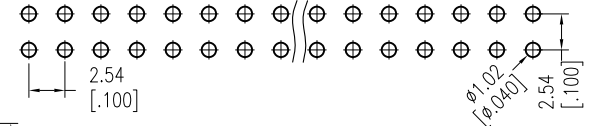

Ordering Information

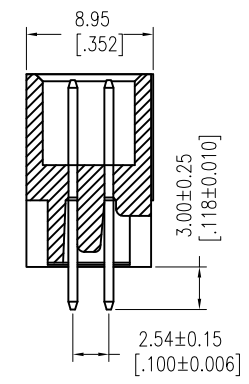
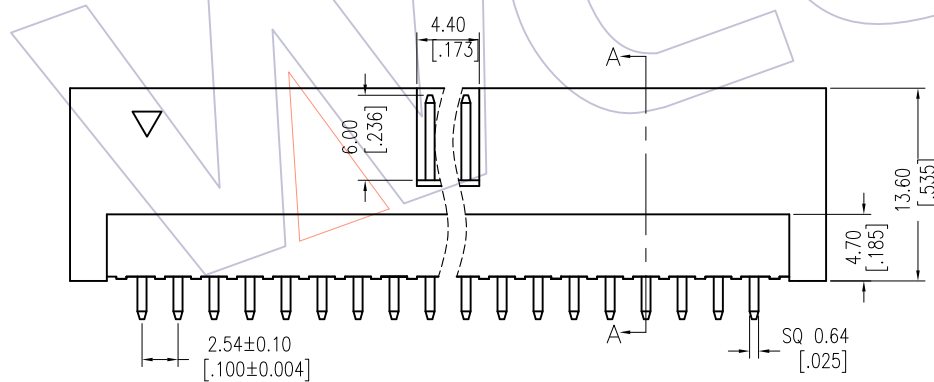

3112-XX S XX B K00 X 1

| | | | |
|----------------------------------------------------------------|----------------------------------------------------------------------------------------------------------------------------------------------------|---------------------------------------------------|------------------|
| No.of Pins | Contact Plating | Color Insulator | Packing: |
| 10P 30P 14P 34P 16P 40P 20P 50P 24P 60P 26P 64P | G0=Gold Flash G3=10u"Gold G4=15u"Gold G5=30u"Gold S0=Gold Flash/Tin S3=10u"Gold/Tin S4=15u"Gold/Tin S5=30u"Gold/Tin SN=Tin | B=Black U=blue G=Gray(427C) E=Gray(413C) | A=Tray T=Tube |



A(TOLERANCE)

| ITEM | ≤20P | >20P |
|------|-------|-------|
| A | ±0.20 | ±0.30 |

| | | | | | | | | | |
|-----|------------|--------------------------|-------------------------------------------------------------------------------------|-------------|---------|------------|-------|---------------------------------------------------------------------------------------|-----------------------------|
| | | | | OPERATION | DRAW | DATE | SCALE | FIT | PART NO. |
| | | | | x.X ±0.40 | Allen | 2014/05/05 | UNIT | mm | 3112-XXSXXBK00XX |
| A1 | 2014/05/05 | MODIFY |  | x.XX ±0.25 | CHECK | DATE | SIZE | A4 | TITLE: |
| AO | 2012/09/25 | NEW | ----- | x.XXX ±0.15 | APPROVE | DATE | SHEET | 1/1 | 2.54 BOX HEADER 180° H=13.6 |
| REV | DATE | MODIFICATION DESCRIPTION | CHANGE | Angle ± 3' | | | PROJ. |  | Customer NO. |
| | | | | DIM TOL | | | | | |

WCON

Http: www.wcon.com

| | |
|-------------------------------------------------------------------------------------------|--------------------------------------------------------------------------------------------|
| WCON-Dongguan Tel: +86 769 85358920 Fax: +86 769 85358915 E-mail: sales@wcon.com | WCON-Kunshan Tel: +86 512 57468408 Fax: +86 512 57468468 E-mail: salesks@wcon.com |
|-------------------------------------------------------------------------------------------|--------------------------------------------------------------------------------------------|