

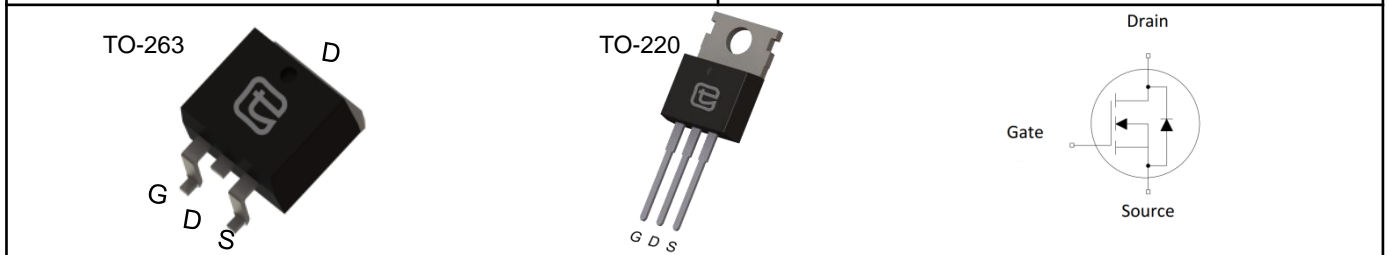

85V N-Channel Trench MOSFET(Preliminary)

<p>General Description</p> <ul style="list-style-type: none"> ● Trench Power Technology ● Low $R_{DS(ON)}$ ● Low Gate Charge ● Optimized for fast-switching Applications <p>Applications</p> <ul style="list-style-type: none"> ● Synchronous Rectification in DC/DC and AC/DC Converters ● Isolated DC/DC Converters in Telecom and Industrial 	<p>Product Summary</p> <p>V_{DS} 85V</p> <p>I_D (at $V_{GS}=10V$) 85A</p> <p>$R_{DS(ON)}$ (at $V_{GS}=10V$) < 9mΩ</p> <p>100% UIS Tested</p> 
--	---



Device	Package	Form	Marking
TTB85N08A	TO-263	Tape & Reel	85N08A
TTP85N08A	TO-220	Tube	85N08A

Absolute Maximum Ratings ($T_A = 25^\circ C$ unless otherwise noted)			
Parameter	Symbol	Maximum	Units
Drain-Source Voltage	V_{DS}	85	V
Gate-Source Voltage	V_{GS}	± 20	V
Continuous Drain Current ^B	I_D	$T_C = 25^\circ C$	85
		$T_C = 100^\circ C$	55
Pulsed Drain Current ^A	I_{DM}	255	A
Avalanche Current ^A	I_{AS}	40	A
Single Pulse Avalanche Energy $L = 0.3mH$ ^A	E_{AS}	240	mJ
Power Dissipation ^C	P_D	$T_C = 25^\circ C$	160
		$T_C = 100^\circ C$	78
Operating Junction and Storage Temperature Range	T_J, T_{SGT}	-55 to 175	$^\circ C$

Thermal Resistance			
Parameter		Symbol	Units
Thermal Resistance, Junction-to-Case	Steady-State	R_{thJC}	0.95
Thermal Resistance, Junction-to-Ambient	Steady-State	R_{thJA}	100



Electrical Characteristics($T_J = 25^\circ\text{C}$ unless otherwise noted)							
Symbol	Parameter	Conditions	Value			Units	
			Min	Typ	Max		
STATIC PARAMETERS							
BV_{DSS}	Drain-Source Breakdown Voltage	$I_D = 250\mu\text{A}, V_{GS} = 0\text{V}$	85	--	--	V	
I_{DSS}	Zero Gate Voltage Drain Current	$V_{DS} = 85\text{V}, V_{GS} = 0\text{V}$	$T_J = 25^\circ\text{C}$	--	--	1	μA
			$T_J = 100^\circ\text{C}$	--	--	25	
I_{GSS}	Gate-Body Leakage Current	$V_{DS} = 0\text{V}, V_{GS} = \pm 20\text{V}$	--	--	± 100	nA	
$V_{GS(th)}$	Gate Threshold Voltage	$V_{DS} = V_{GS}, I_D = 250\mu\text{A}$	2	3	4	V	
$R_{DS(ON)}$	Static Drain-Source On-Resistance	$V_{GS} = 10\text{V}, I_D = 30\text{A}$	--	8.4	9	m Ω	
g_{FS}	Forward Transconductance	$V_{DS} = 5\text{V}, I_D = 20\text{A}$	30	--	--	S	
V_{SD}	Diode Forward Voltage	$I_S = 20\text{A}, V_{GS} = 0\text{V}$	--	--	1	V	
I_S	Maximum Body-Diode Continuous Current ^B		--	--	85	A	
DYNAMIC PARAMETERS							
C_{iss}	Input Capacitance	$V_{GS} = 0\text{V}, V_{DS} = 40\text{V}, f = 1\text{MHz}$	--	5400	--	μF	
C_{oss}	Output Capacitance		--	245	--		
C_{rss}	Reverse Transfer Capacitance		--	204	--		
SWITCHING PARAMETERS							
$Q_g(10\text{V})$	Total Gate Charge	$V_{GS} = 10\text{V}, V_{DS} = 40\text{V}, I_D = 20\text{A}$	--	92	--	nC	
Q_{gs}	Gate Source Charge		--	27	--		
Q_{gd}	Gate Drain Charge		--	21	--		
$t_{D(on)}$	Turn-On Delay Time	$V_{GS} = 10\text{V}, V_{DS} = 40\text{V}, I_D = 20\text{A}, R_G = 2.5\Omega$	--	24	--	ns	
t_r	Turn-On Rise Time		--	19	--		
$T_{D(off)}$	Turn-Off Delay Time		--	70	--		
t_f	Turn-Off Fall Time		--	30	--		
t_{rr}	Body Diode Reverse Recovery Time	$I_F = 20\text{A}, di/dt = 100\text{A}/\mu\text{s}$	--	37	--	ns	
Q_{rr}	Body Diode Reverse Recovery Charge		--	58	--	nC	

A. Single pulse width limited by maximum junction temperature.

B. The maximum current rating is package limited.

C. The power dissipation P_D is based on $T_{J(MAX)} = 175^\circ\text{C}$, using junction-to-case thermal resistance, and is more useful in setting the upper dissipation limit for cases where additional heatsinking is used.



Typical Characteristics $T_J = 25^\circ\text{C}$, unless otherwise noted

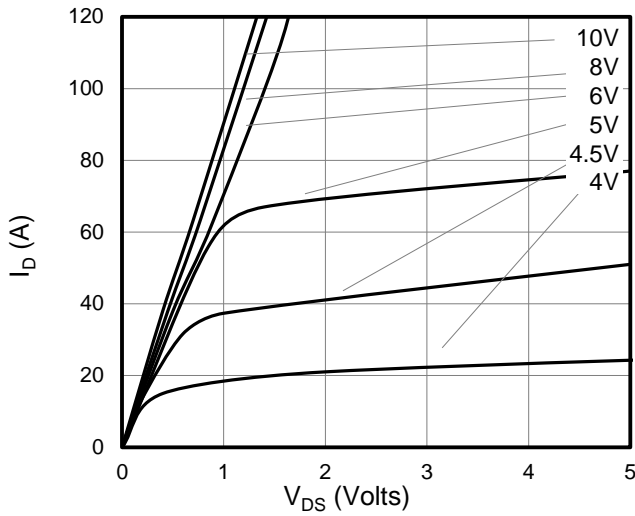

Figure 1: On-Region Characteristics

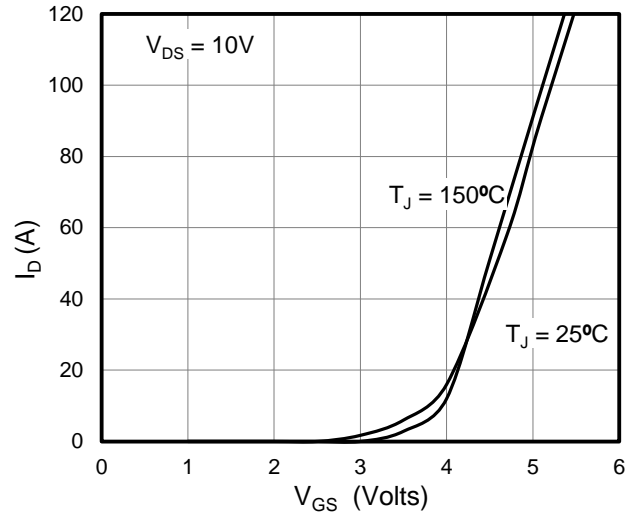

Figure 2: Transfer Characteristics

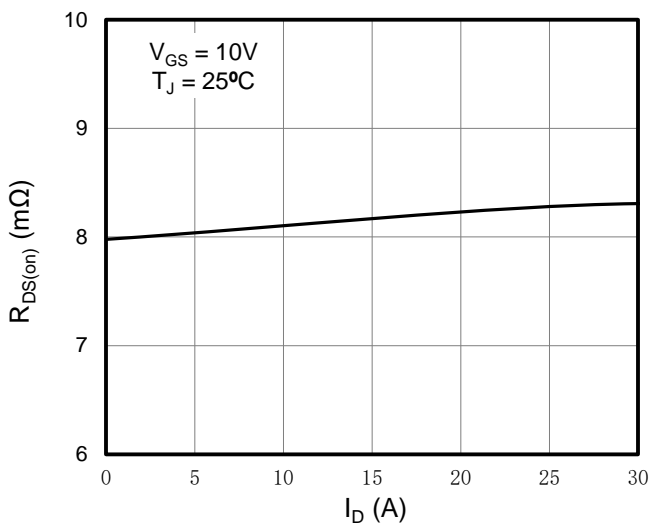

Figure 3: On-Resistance vs. Drain Current

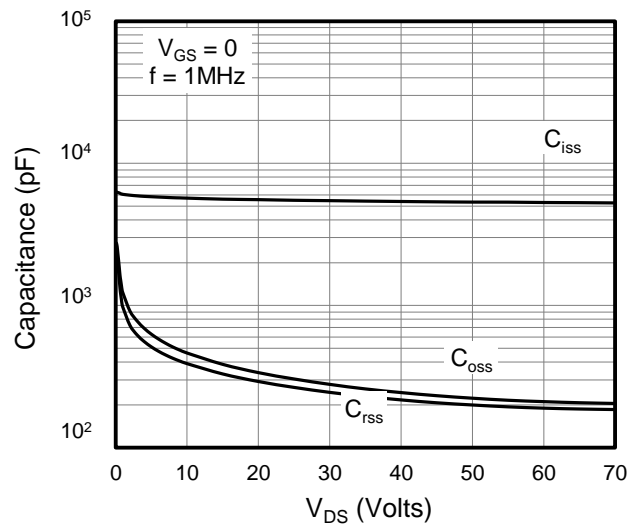

Figure 4: Capacitance Characteristics

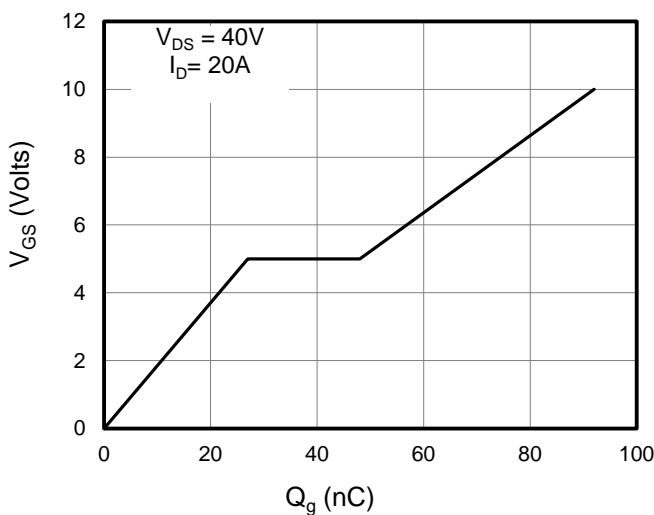

Figure 5: Gate Charge Characteristics

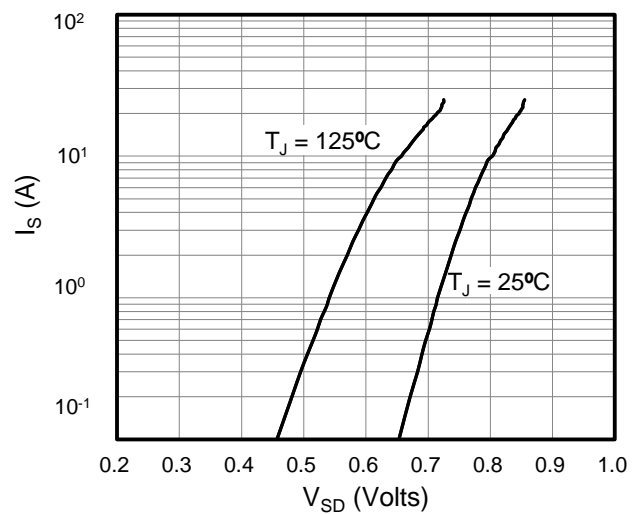

Figure 6: Body Diode Forward Voltage



Typical Characteristics $T_J = 25^\circ\text{C}$, unless otherwise noted

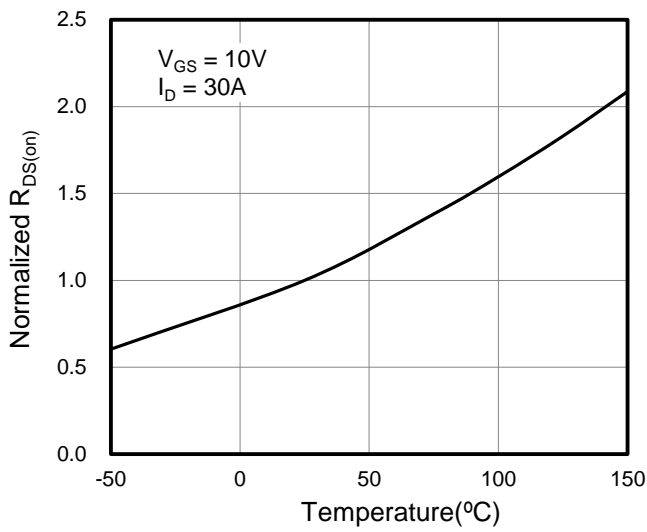

Figure 7: On-Resistance vs. Junction Temperature

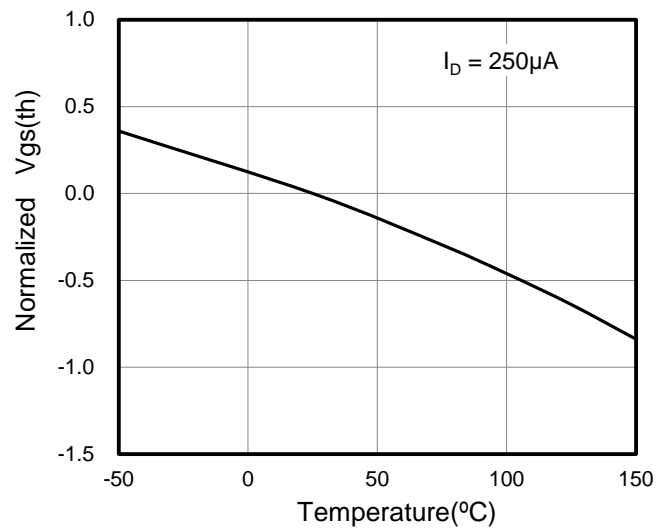

Figure 8: $V_{GS(th)}$ vs. Junction Temperature

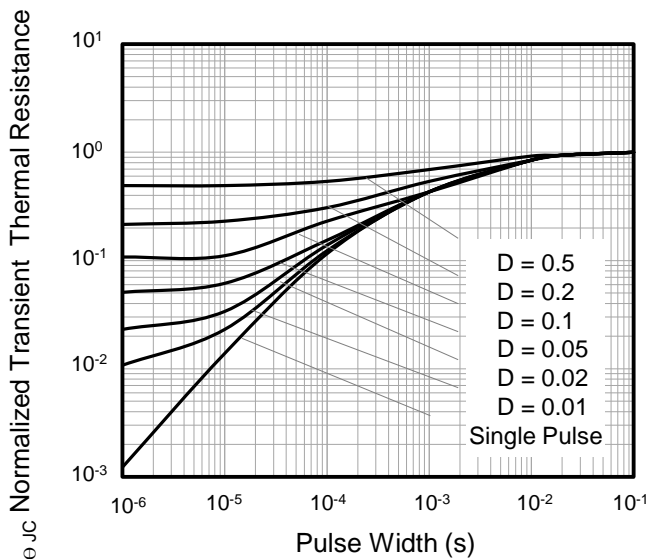

Figure 9: Normalized Transient Thermal Resistance

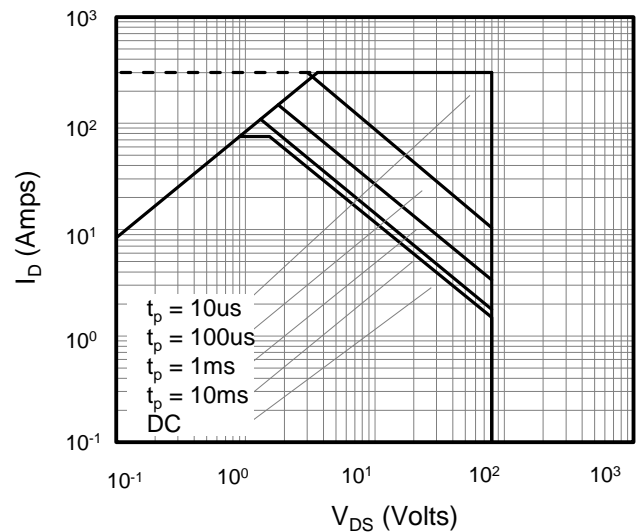

Figure 10: Safe Operating Area



Figure A: Gate Charge Test Circuit and Waveform



Figure B: Resistive Switching Test Circuit and Waveform

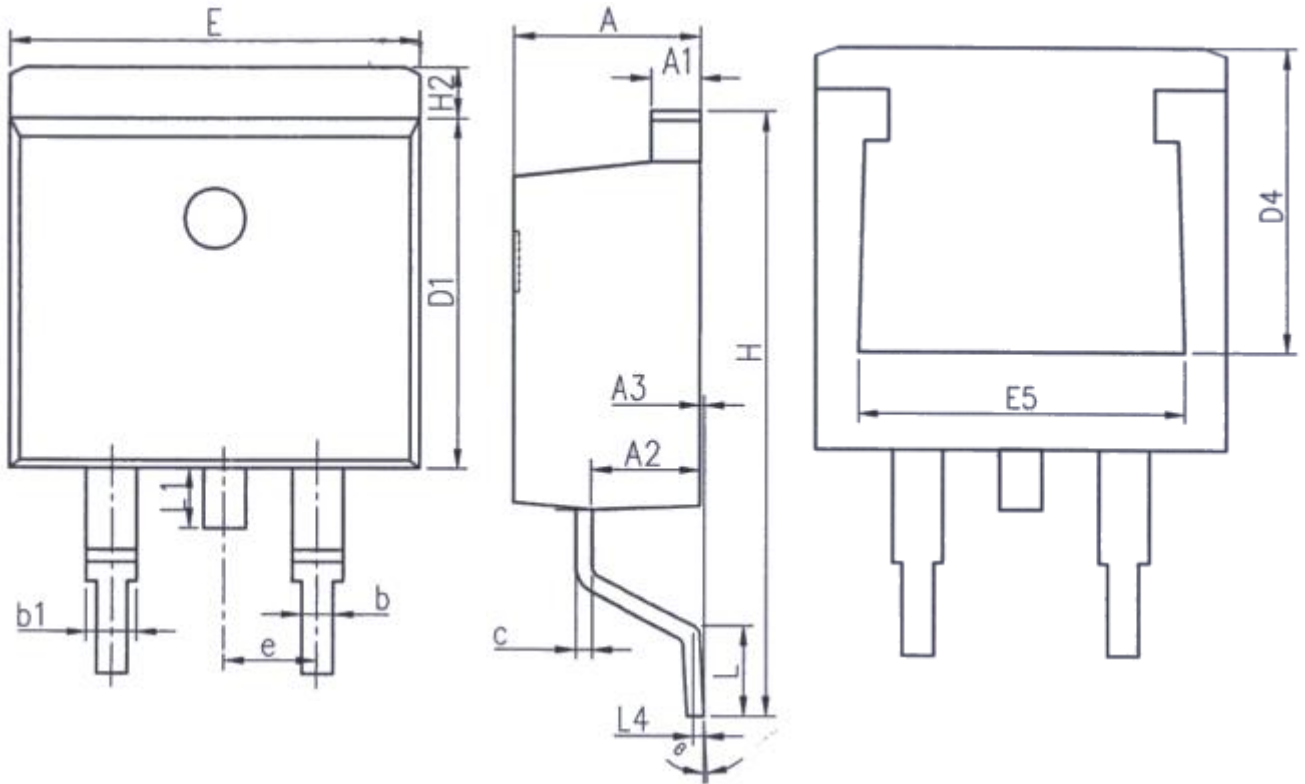

Figure C: Unclamped Inductive Switching Test Circuit and Waveform





TO-263



Unit: mm		
Symbol	Min.	Max.
A	4.37	4.77
A1	1.22	1.42
A2	2.49	2.89
A3	0.00	0.25
b	0.70	0.96
b1	1.17	1.47
c	0.30	0.53
D1	8.50	8.90
D4	6.60	-

Unit: mm		
Symbol	Min.	Max.
E	9.86	10.36
E5	7.06	-
e	2.54BSC	
H	14.70	15.50
H2	1.07	1.47
L	2.00	2.60
L1	1.40	1.70
L4	0.25BSC	
θ	0°	9°



TO-220

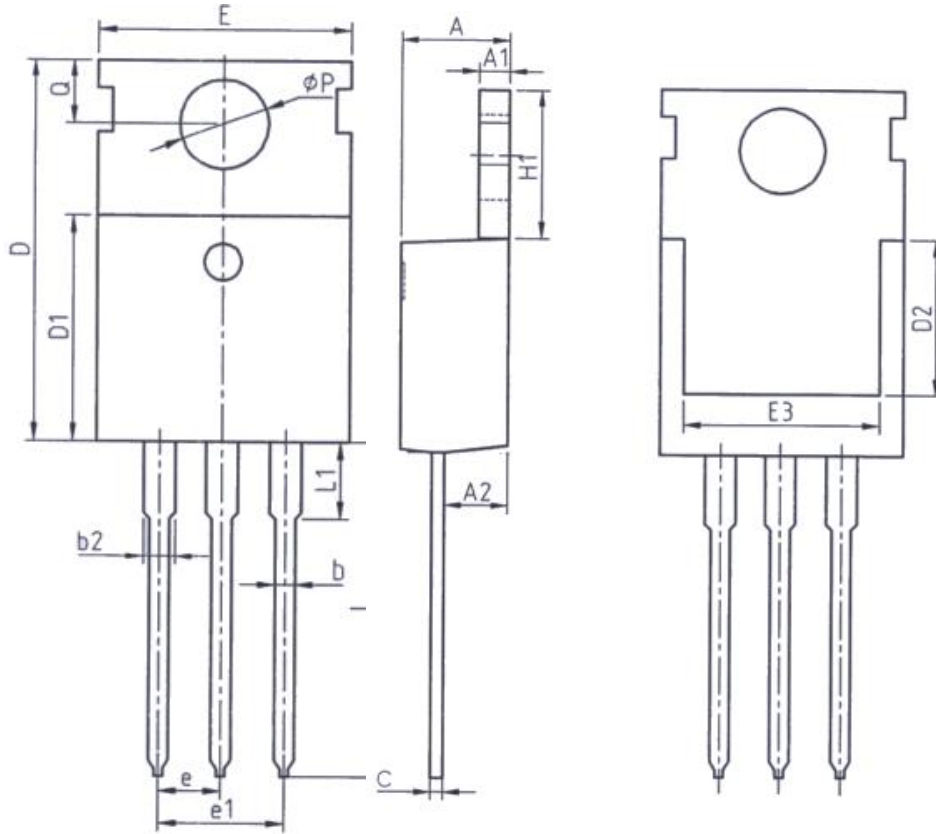

Unit: mm		
Symbol	Min.	Max.
A	4.37	4.77
A1	1.25	1.45
A2	2.20	2.60
b	0.70	0.95
b2	1.17	1.47
c	0.40	0.65
D	15.10	16.10
D1	8.80	9.40
D2	5.50	-

Unit: mm		
Symbol	Min.	Max.
E	9.70	10.30
E3	7.00	-
e	2.54BSC	
e1	5.08BSC	
H1	6.25	6.85
L	12.75	13.80
L1	-	3.40
P	3.40	3.80
Q	2.60	3.00



Disclaimer

All product specifications and data are subject to change without notice.

For documents and material available from this datasheet, Wuxi Unigroup does not warrant or assume any legal liability or responsibility for the accuracy, completeness of any product or technology disclosed hereunder.

No license, express or implied, by estoppels or otherwise, to any intellectual property rights is granted by this document or by any conduct of Wuxi Unigroup.

The products shown herein are not designed for use in medical, life-saving, or life-sustaining applications. Customers using or selling Wuxi Unigroup products not expressly indicated for use in such applications do so entirely at their own risk and agree to fully indemnify Wuxi Unigroup for any damages arising or resulting from such use or sale.

Wuxi Unigroup disclaims any and all liability arising out of the use or application of any product described herein or of any information provided herein to the maximum extent permitted by law. The product specifications do not expand or otherwise modify Wuxi Unigroup's terms and conditions of purchase, including but not limited to the warranty expressed therein, which apply to these products.

Wuxi Unigroup Microelectronics CO., LTD. strives to supply high-quality high-reliability products. However, any and all semiconductor products fail with some probability. It is possible that these probabilistic failures could give rise to accidents or events that could endanger human lives that could give rise to smoke or fire, or that could cause damage to other property. When designing equipment, adopt safety measures so that these kinds of accidents or events cannot occur. Such measures include but are not limited to protective circuits and error prevention circuits for safe design, redundant design, and structural design.

In the event that any or all Wuxi Unigroup products (including technical data, services) described or contained herein are controlled under any of applicable local export control laws and regulations, such products must not be exported without obtaining the export license from the authorities concerned in accordance with the above law.

Information (including circuit diagrams and circuit parameters) herein is for example only. It is not guaranteed for volume production. Wuxi Unigroup believes information herein is accurate and reliable, but no guarantees are made or implied regarding its use or any infringements of intellectual property rights or other rights of third parties.